



DC UNIVERSE™

# SUPER HEROES



76002



© 2011 DC ENTERTAINMENT™



1x

1

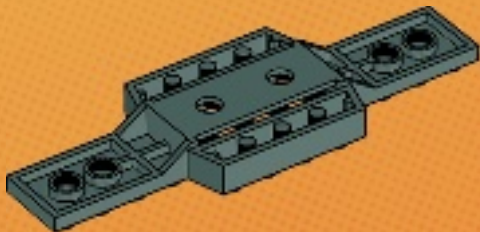

2



2x



1x

2

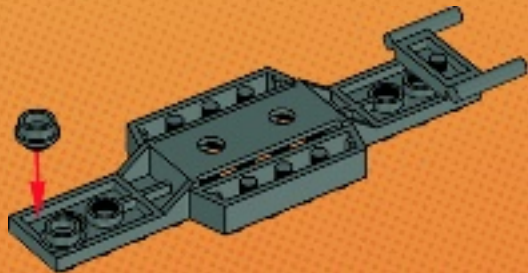



4x

3

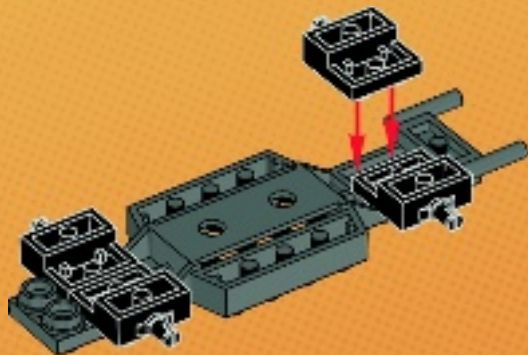

4



2x

4

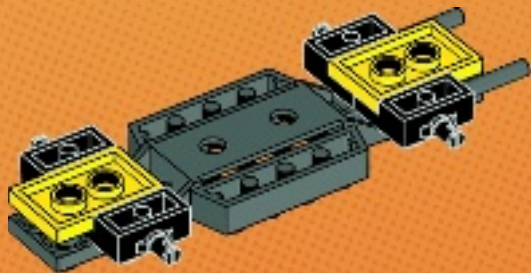



1x



1x

5

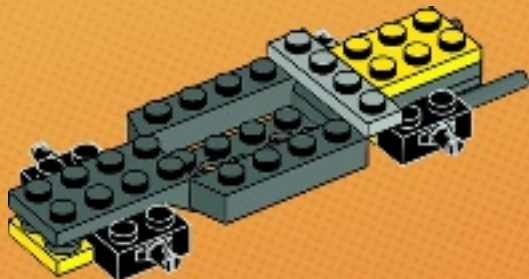
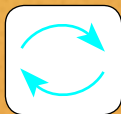

6



4x

6

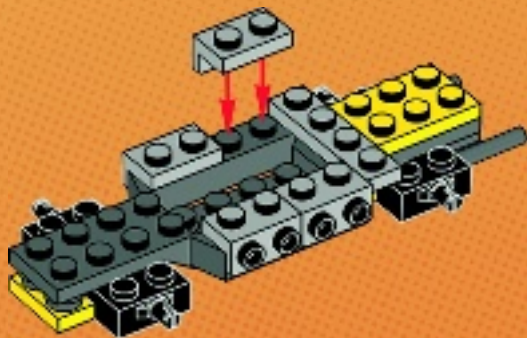



1x

7

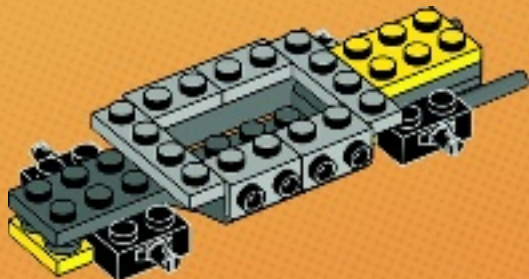

8





2x



1x

8

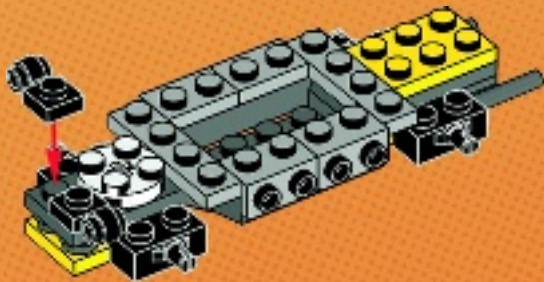



2x



1x

9

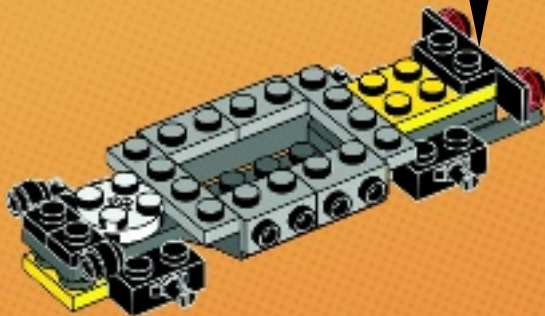
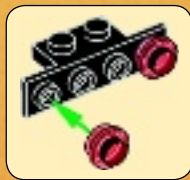



1x

10

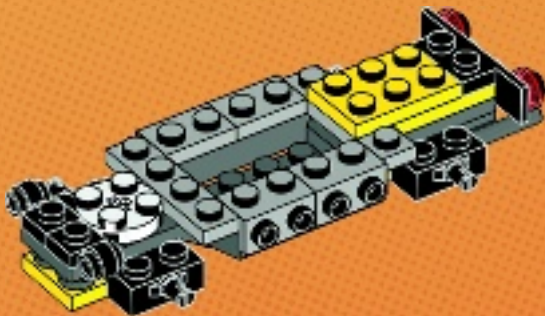



2x



1x

# 11

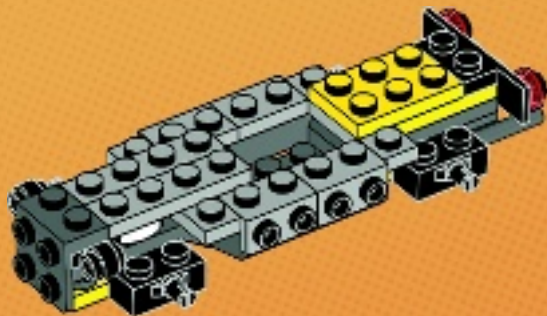



1x



2x

# 12

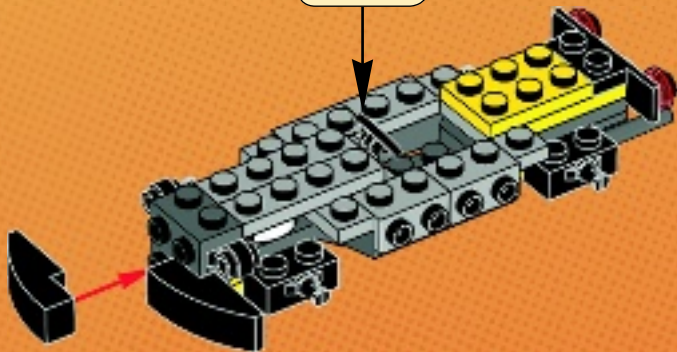



2x



1x

# 13

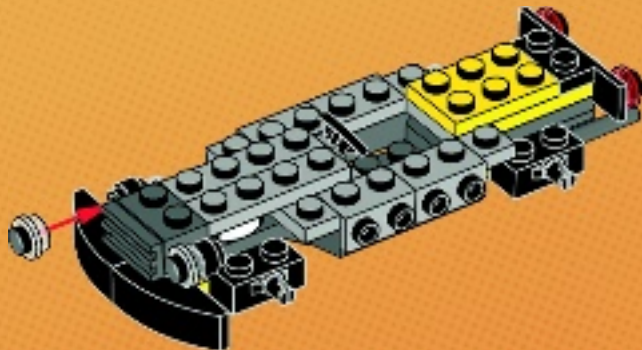



4x

14

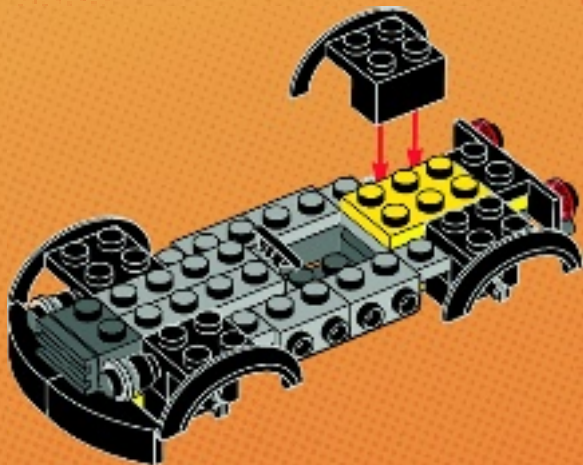



4x



4x

# 15



4x

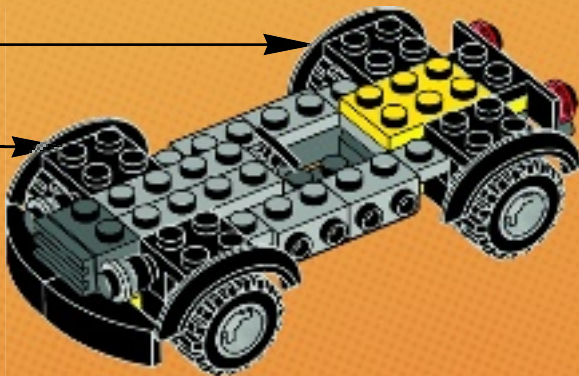





# 16

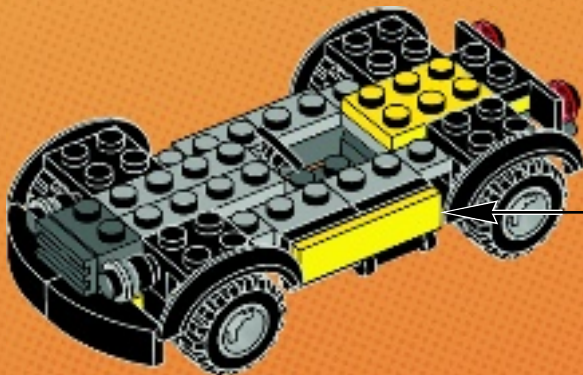
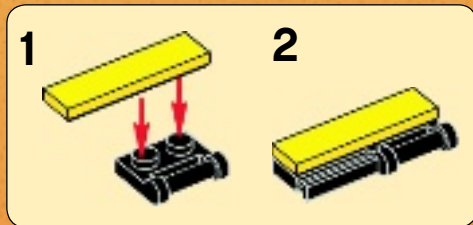



1x



1x



1x

# 17

1

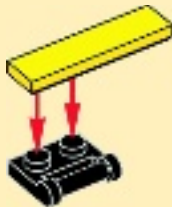

2

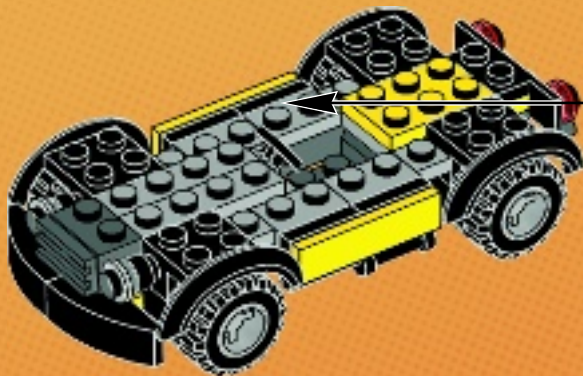
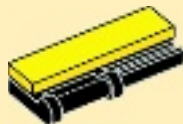



4x

# 18

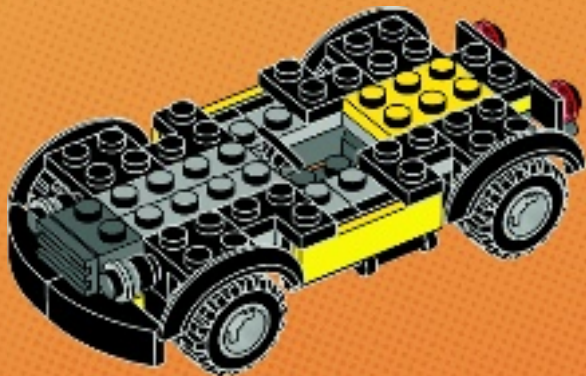

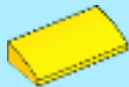

1x



2x

# 19

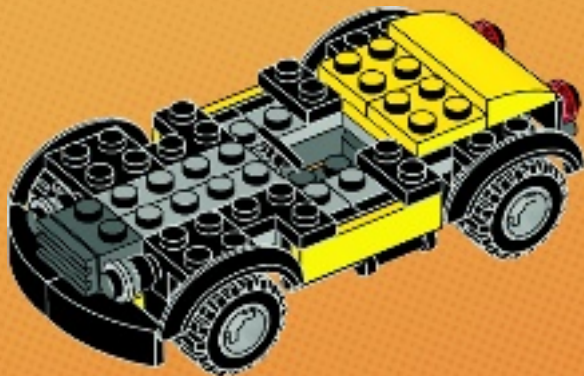



2x



2x

# 20





2x

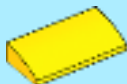

1x

# 21



22



1x



2x



2x

# 22

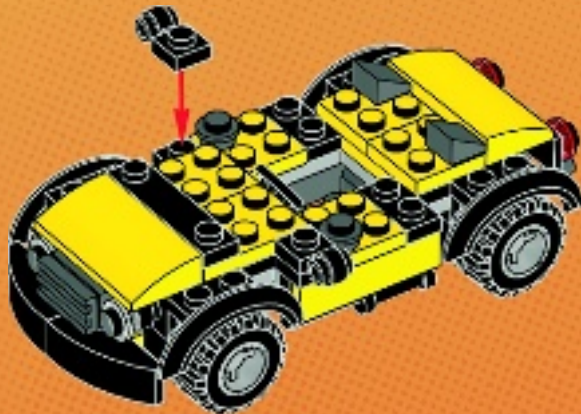



4x

# 23



24





1x

24



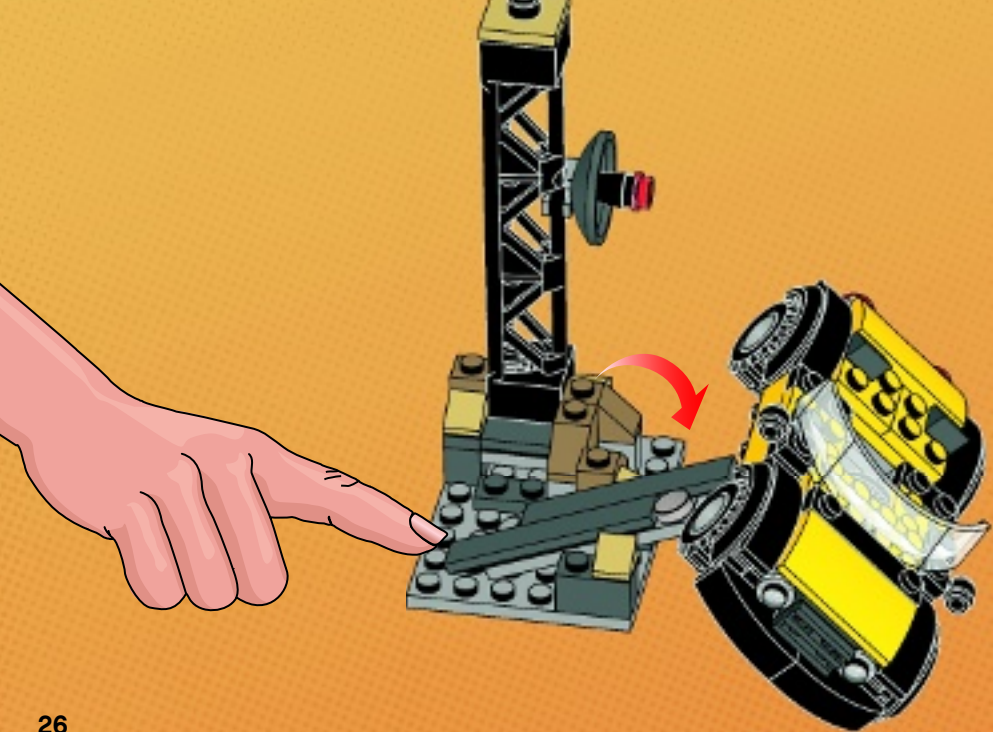





1x  
403201



4x  
4516055



1x  
4565387



1x  
4143210



4x  
302224



6x  
302124



2x  
243124

28



2x  
4597902



1x  
4529236



2x  
4251161



4x  
4613153



4x  
242026



1x  
4599499



4x  
4632571



2x  
4107761



1x  
395726



1x  
6041729



1x  
6039687



1x  
4654944



1x  
4667463



1x  
4651571



4x  
4568644



4x  
448826



2x  
4225201



1x  
4282746



4x  
4648117



1x  
4523573



2x  
3005740



3x  
3005741



4x  
4530678



1x  
6041728



1x  
6039684



4x  
4211445



1x  
4211408



3x  
4211389



1x  
4541978



4x  
4654582



1x  
4211394



2x  
4211376



4x  
4211764



1x  
4226995



1x  
4211452



1x  
4277928



4x  
4211087



2x  
4504378



4x  
4211063



1x  
4210631



2x  
4210651



1x  
4259673



1x  
4211055



1x  
4263176



4x  
4210633



1x  
4210865



1x  
6037902



1x  
6037903



1x  
4655241



**Customer Service**

**Kundenservice**

**Service Consommateurs**

**Servicio Al Consumidor**

**LEGO.com/service or dial**





# OF SUPER HEROES BATMAN™



LEGO and the LEGO logo are trademarks of the/son't des marques de com-  
merce del/son marcas registradas de LEGO Group.  
©2013 The LEGO Group. TM & © DC Comics. WB SHIELD. TM & ©  
Warner Bros Entertainment Inc. (S18)

7+



2-4



15-25



## GAMES



Available on the  
App Store



[LEGO.com/SuperHeroes](http://LEGO.com/SuperHeroes)



LEGO UNIVERSE™  
**SUPER  
HEROES**

# **MOVIE MAKER** **CRÉATEUR DE FILM**

*SHOOT, EDIT & SHARE YOUR STOP MOTION MOVIE*  
*TOURNE, MONTE ET PARTAGE TON FILM D'ANIMATION*

LEGO and the LEGO logo are trademarks of the LEGO Group. TM & © DC Comics. (s13)



# WIN!

Go to [www.LEGOsurvey.com/product](http://www.LEGOsurvey.com/product) to fill out a survey for a chance to win a cool LEGO® Product.

No purchase necessary.

Open to all residents where not prohibited.



## [www.LEGOsurvey.com/product](http://www.LEGOsurvey.com/product)

### GEWINNE!

Nimm an der Umfrage auf [www.LEGOsurvey.com/product](http://www.LEGOsurvey.com/product) teil und hab die Chance ein cooles LEGO® Produkt zu gewinnen!

Die Teilnahme am Gewinnspiel führt zu keinerlei Kaufverpflichtungen. Teilnahme in allen nicht ausgeschlossenen Ländern möglich.

6047347



[LEGO.com](http://LEGO.com)



DC COMICS™ TM & © DC Comics.

### WIN!

Ga naar [www.LEGOsurvey.com/product](http://www.LEGOsurvey.com/product), vul een enquêteformulier in en maak kans op een

cool LEGO® product.

Geen aankoopverplichting.

Iedereen mag deelnemen, uitgezonderd ingezetenden van landen waar een enquêteverbod geldt.

### GAGNE !

Visite [www.LEGOsurvey.com/product](http://www.LEGOsurvey.com/product) pour répondre à un questionnaire et avoir une chance de gagner un produit LEGO® très cool !

Aucune obligation d'achat.

Ouvert à tous les résidents des pays autorisés.

### 当てよう!

[www.LEGOsurvey.com/product](http://www.LEGOsurvey.com/product) にアクセスして、アンケートにご記入ください。当選者にはレゴ製品を差し上げます。

お買い上げの必要はありません。

禁止されていない限り、すべての皆様にご利用いただけます。



WB SHIELD: TM & © Warner Bros. Entertainment Inc. (s13)

LEGO and the LEGO logo are trademarks of the/sont des marques de commerce de/son marcas registradas de LEGO Group. ©2013 The LEGO Group.