

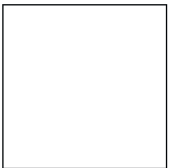

Booklet available in English on
Livret disponible en français sur
Folleto disponible en español en





WE'RE MAKING OUR PACKAGING MORE SUSTAINABLE

We're transitioning from single-use plastic to paper-based packaging. As we progress, you may find a mix of paper and plastic in our boxes.

NOUS RENDONS NOS EMBALLAGES PLUS DURABLES

Nous passons des emballages en plastique à usage unique aux emballages à base de papier. Durant la transition, vous pourriez trouver un mélange de papier et de plastique dans nos boîtes.

QUEREMOS HACER MÁS SUSTENTABLES NUESTROS MATERIALES DE EMBALAJE

Estamos cambiando las bolsas de plástico desechables por bolsas con base de papel. Conforme avanzamos en este propósito, puedes encontrar una mezcla de papel y de plástico en nuestras cajas.

LEGO.com/sustainable-packaging

LEGO® VIP

- 1.** SIGN UP
INSCRIVEZ-VOUS
REGÍSTRATE

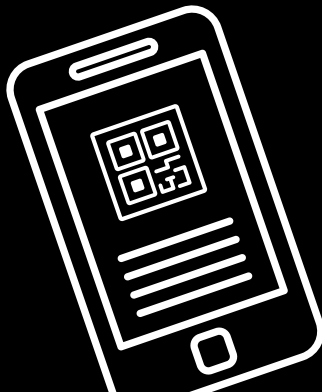

- 2.** EARN POINTS
FOR PURCHASES
GAGNEZ DES POINTS
POUR VOS ACHATS
GANA PUNTOS POR
TUS COMPRAS

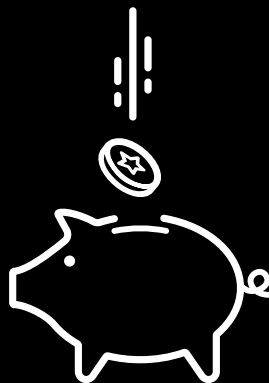

- 3.** REDEEM POINTS FOR REWARDS, EXPERIENCES,
DISCOUNTS & MORE
ÉCHANGEZ DES POINTS CONTRE DES RÉCOMPENSES,
DES EXPÉRIENCES, DES RÉDUCTIONS ET PLUS ENCORE
CANJEA PUNTOS POR RECOMPENSAS, EXPERIENCIAS,
DESCUENTOS Y MUCHO MÁS

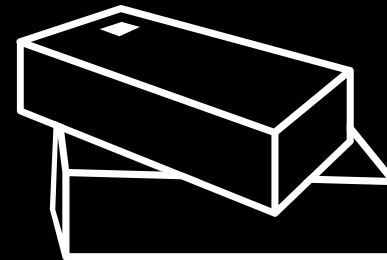
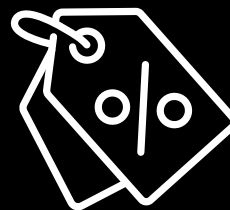



MEET THE VIKINGS

DÉCOUVREZ LES VIKINGS

CONOCE A LOS VIKINGOS

∞ The men and women of the Viking age may have a reputation for being merciless plunderers and pillagers, but Viking culture is much more diverse. They were curious explorers, resourceful sailors and tradespeople, creative cooks, carpenters, weavers, jewelers, farmers, fishermen, storytellers and much more. The word "Viking" was mainly used to refer to expeditions. And though no signs of horned helmets have emerged from archeological digs, who knows if Vikings experimented with different fashion styles to show off status, clan colors, or simply just for fun! Viking-age men and women enjoyed equal rights in many respects, from participating in overseas voyages and tending to the home and different occupations, to local council representations, marital rights and property ownership.

∞ Les hommes et les femmes de l'époque des Vikings ont peut-être la réputation d'être d'impitoyables pillards, mais la culture viking est bien plus diversifiée. Ils étaient des explorateurs curieux, des marins et des commerçants ingénieux, des cuisiniers créatifs, des charpentiers, des tisserands, des bijoutiers, des agriculteurs, des pêcheurs, des conteurs et bien d'autres choses encore. Le mot « Viking » était surtout utilisé pour désigner les expéditions. Et bien qu'aucune trace de casques à cornes n'ait été retrouvée dans les fouilles archéologiques, qui sait si les Vikings ont adopté différents styles pour montrer leur statut, arborer les couleurs de leur clan ou tout simplement pour s'amuser ? Les hommes et les femmes de l'époque des Vikings jouissaient de droits égaux à bien des égards, qu'il s'agisse des voyages outre-mer, de l'entretien du foyer, des différents métiers, de la représentation au conseil local, des droits matrimoniaux ou de la propriété.

∞ Si bien los hombres y mujeres de la época vikinga tienen fama de haber sido saqueadores voraces y despiadados, su cultura es algo mucho más profundo y diverso. Como exploradores, los vikingos destacaban por su curiosidad. También eran ingeniosos marineros y comerciantes, así como creativos cocineros, carpinteros, tejedores, joyeros, granjeros, pescadores y narradores de historias, entre muchas otras cosas. La palabra *vikingo* se utilizaba principalmente para referirse a las expediciones. Y aunque no se han encontrado indicios de cascos con cuernos en las excavaciones arqueológicas, nadie sabe a ciencia cierta si los vikingos experimentaban con diferentes estilos de moda o colores para mostrar su estatus o afiliación a un clan, ¡o si lo hacían simplemente por diversión! Los hombres y las mujeres de la era vikinga gozaban de igualdad de derechos en muchos aspectos, desde la participación en los viajes a ultramar, el cuidado del hogar y otras ocupaciones hasta la representación en los consejos locales, los derechos matrimoniales y la propiedad de bienes.



COMMUNITY

COMMUNAUTÉ

COMUNIDAD

∞ Viking communities were typically ruled by "Jarls" (wealthy authoritative figures), with "Karls" representing the "working class," and "Thralls" or slaves. Though laws were not specifically written down, communities would pass on their customs and culture verbally and through rituals and practices. They assembled regularly to vote on important issues, settle disputes, and catch up on the news of the land. Words, both spoken and in rune symbols, in particular, were believed to have a powerful effect, good or bad, on everything in the physical world. The word rune, from the Old Norse "rún" or "rúna," means a whisper, a secret, or advice, and unkind or damning words towards the gods or your fellow humans were believed to cause devastating consequences.

∞ Les communautés vikings étaient généralement dirigées par des « Jarls » (riches figures d'autorité), avec des « Karls » (la « classe ouvrière ») et des « Thralls » ou esclaves. Bien que les lois n'aient pas été spécifiquement écrites, les communautés transmettaient leurs coutumes et leur culture oralement et par le biais de rituels et de pratiques. Ils se réunissaient régulièrement pour voter sur les questions importantes, régler les différends et s'informer des nouvelles du pays. On attribuait aux mots, qu'ils soient prononcés ou écrits en symboles runiques, un effet puissant, bon ou mauvais, sur tout ce qui se trouve dans le monde physique. Le mot rune, du vieux norrois « rún » ou « rúna », signifie un murmure, un secret ou un conseil, et l'on croyait que des paroles malveillantes ou accablantes à l'égard des dieux ou de ses semblables auraient des conséquences dévastatrices.

∞ Las comunidades vikingas solían ser gobernadas por *jarls* (figuras de autoridad adineradas). Allí también había *karls*, que representaban a la clase trabajadora, y *thralls*, o esclavos. No tenían leyes escritas con todo detalle, pero las comunidades transmitían sus costumbres y cultura verbalmente y mediante rituales y prácticas. Los vikingos también tenían la costumbre de reunirse con regularidad para someter a votación los asuntos importantes, resolver disputas y ponerse al día de las noticias de sus territorios. Se creía que las palabras, ya fuera habladas o representadas con símbolos rúnicos (particularmente estas últimas), tenían un poderoso efecto en el mundo físico tanto para bien como para mal. La palabra *runa*, del nórdico antiguo rún o rúna, significa 'susurro', 'secreto' o 'consejo'. Es de destacar que entre los vikingos existía la firme creencia de que proferir palabras poco amables o maldecir a los dioses o a los semejantes tenía consecuencias devastadoras.





STYLE APPARENCE ESTILO

∞ Vikings were creative problem-solvers who enjoyed cooking delicious meals and creating beautiful arts and crafts, elaborate hairstyles and clothes. Both men and women shampooed their hair with a potent lye-based soap that lightened their hair, allowing even brunettes to achieve the signature blond Viking locks. Whether out of vanity or practicality, it was an effective way to keep lice at bay!

∞ Les Vikings étaient des personnes créatives qui aimaient cuisiner de délicieux repas et créer de magnifiques objets d'art et d'artisanat, des coiffures et des vêtements élaborés. Les hommes comme les femmes se lavaient les cheveux avec un puissant savon à base de soude qui éclaircissait les cheveux, permettant même aux personnes à la chevelure brune d'arborer les mèches blondes caractéristiques des Vikings. Qu'elle ait été adoptée par vanité ou par praticité, cette coutume était un moyen efficace de tenir les poux à distance !

∞ Los vikingos tenían una gran creatividad para resolver problemas, y entre las cosas que más disfrutaban estaban cocinar comida deliciosa y crear hermosas artesanías, así como peinados y prendas sumamente elaborados. Tanto los hombres como las mujeres se lavaban el pelo con un potente jabón a base de lejía que lo aclaraba, por lo que incluso los más morenos lucían los mechones rubios tan característicos de este pueblo. Ya fuera por vanidad o por sentido práctico, ¡era una forma muy eficaz de mantener a raya a los piojos!

CAREERS CARRIÈRES PROFESIONES

∞ Every skill was important to a community's status, health and wealth. Farming, fishing, hunting, and preserving food for the cold seasons were vital to survival. Fish, game and produce were dried, salted, pickled, smoked and infused with herbs. Blacksmiths forged weapons for voyages or battle, but also essential tools, kitchenware and jewelry. Weavers, glass bead makers, woodturners, carpenters and potters each made valuable and decorative objects for everyday use and goods to trade on commercial expeditions. In return (or as part of their plunder), Vikings would bring back precious metal jewelry or clothes.

∞ Chaque compétence jouait un rôle important dans le statut, la santé et la richesse d'une communauté. L'agriculture, la pêche, la chasse et la conservation des aliments pour les saisons froides étaient essentielles à la survie. Le poisson, le gibier et les fruits et légumes étaient séchés, salés, marinés, fumés et agrémentés d'herbes. Les forgerons forgeaient des armes pour les voyages ou les batailles, mais aussi des outils essentiels, des ustensiles de cuisine et des bijoux. Les tisserands, les fabricants de perles de verre, les tourneurs de bois, les charpentiers et les potiers fabriquaient tous des objets précieux et décoratifs pour l'usage quotidien, ainsi que des marchandises pour les expéditions commerciales. En échange (ou comme partie de leur butin), les Vikings rapportaient des vêtements ou des bijoux en métal précieux.

∞ Todos los oficios eran importantes para el estatus, la salud y la prosperidad de una comunidad. La agricultura, la pesca, la caza y la preservación de alimentos para las estaciones frías eran vitales para la supervivencia. El pescado, la carne de caza y los productos vegetales se secaban, salaban, encurtían, ahumaban e impregnaban con hierbas. Los herreros producían armas tanto para los viajes como para la guerra, aunque también hacían herramientas esenciales, utensilios de cocina y joyas. Los tejedores, fabricantes de cuentas de vidrio, torneros, carpinteros y alfareros fabricaban objetos valiosos y decorativos para el uso cotidiano y mercancías para intercambiar en expediciones comerciales. A cambio (o como parte de sus botines), los vikingos traían joyas de metales preciosos o prendas de vestir.





EXPEDITIONS AND TRAVELS

EXPÉDITIONS ET VOYAGES

EXPEDICIONES Y VIAJES

∞ Viking longships were built as warships and must have been a terrifying sight as they approached new shores. But trade ships were just as commonly seen in the Nordic Region, and while not quite as fast as the longships, some of the largest trade ships could hold up to 60 tons of cargo. Evidence of Viking trade has been found in regions as far away as the Eastern shores of the US, Eastern Europe and Russia. A few infamous Vikings even carved "graffiti" runes in prominent places on their expeditions to Turkey and Greece. Closer to home, they enjoyed skiing, both as a means to get around, go hunting – and just for fun!

∞ Les drakkars vikings étaient construits comme des navires de guerre, et il devait être terrifiant de les voir approcher de nouveaux rivages. Toutefois, les navires de commerce étaient tout aussi courants dans la région nordique et, bien qu'ils ne soient pas aussi rapides que les drakkars, certains des plus grands navires de commerce pouvaient contenir jusqu'à 60 tonnes de marchandises. Des preuves du commerce viking ont été trouvées dans des régions aussi éloignées que les côtes orientales des États-Unis, l'Europe de l'Est et la Russie. Quelques Vikings odieux ont même gravé des « graffitis » de runes à des endroits bien visibles lors de leurs expéditions en Turquie et en Grèce. Plus près de leur terre, ils pratiquaient le ski, à la fois pour se déplacer, pour chasser et pour s'amuser !

∞ Los vikingos construían embarcaciones alargadas exclusivamente con fines bélicos, y estas deben haber aterrorizado a muchos al aproximarse a nuevas costas. No obstante, los barcos comerciales eran igual de comunes en la región nórdica en esa época y, aunque no eran tan rápidos como las embarcaciones de guerra, algunos de los más grandes podían transportar hasta 60 t de carga. Se han encontrado vestigios de comercio vikingo en regiones tan lejanas como las costas orientales de los EE. UU., el este de Europa y Rusia. Algunos vikingos de infausta memoria llegaron incluso a tallar "graffitis" de runas en lugares prominentes durante sus expediciones a Turquía y Grecia. Más cerca de casa, les gustaba esquiar como medio para desplazarse e ir de cacería, ¡y solo por diversión!



MEET THE FAN DESIGNER

RENCONTRE AVEC LE CONCEPTEUR AMATEUR

CONOCE AL FAN DISEÑADOR

∞ Florian (aka BrickHammer in the LEGO® Ideas community) is a German native with a master's degree in history, English literature and political science. He is a talented and popular contributor to the LEGO Ideas community, with eight submissions reaching 10,000+ supporters so far! Florian actually studied the Norman conquest of 1066 and its influence on Anglo-Saxon society as the main topic for one of his final exams at university:

"Even though this set does not aspire to depict a realistic Viking Village (for one, I included the 100% fictive horns on the helmets), the inspiration for the project was a combination of my interest in Viking history and nostalgia for a classic 1990s LEGO Vikings set (7018 Viking Ship Challenges the Midgard Serpent). My first LEGO Ideas Viking Village project reached 10,000 votes in 2020 but didn't make it through the final approval rounds. In 2022, I submitted an updated, more evolved version which happened to reach 10,000 votes just weeks before the first version was announced as the winner of the Target™ x LEGO Ideas contest. Eventually, we included features from both of my submissions, so you could say you get two 10K models in one! We refined the details, like the stone staircase, the cave, the golden roof decorations and – my favorite – the rope bridge. The classic LEGO rope bridge mold is one of my all-time favorite pieces but it's no longer in production, so we created a brick-built version. In my free time, I train Brazilian Jiu-Jitsu, so we also hid a tiny martial arts Easter egg, too. Thank you, to each and every supporter who has voted for my submissions on LEGO Ideas, especially in the Target™ x LEGO Ideas contest!"



Florian "Brickhammer"

*Florian's original Viking Village submissions.
Left: 2020 version. Right: 2022 version. Can you
spot features from each in the final model?*

*Les modèles originaux du village viking de Florian.
À gauche : la version de 2020. À droite : la version
de 2022. Pouvez-vous repérer les caractéristiques
de chacune des versions dans le modèle final ?*

*Propuestas originales del Poblado Vikingo de
Florian. Izquierda: versión de 2020. Derecha:
versión de 2022. ¿Puedes identificar los elementos
de cada una en el modelo final?*



∞ Florian (alias BrickHammer dans la communauté LEGO® Ideas) est d'origine allemande et titulaire d'une maîtrise en histoire, littérature anglaise et sciences politiques. Il est un contributeur talentueux et populaire de la communauté LEGO Ideas, avec huit créations qui lui ont valu plus de 10 000 votes jusqu'à présent ! Florian a étudié la conquête normande de 1066 et son influence sur la société anglo-saxonne comme sujet principal de l'un de ses examens de fin d'études à l'université :

« Même si cet ensemble n'aspire pas à représenter un village viking réaliste (par exemple, j'ai inclus les cornes entièrement fictives sur les casques), l'inspiration pour ce projet était une combinaison de ma passion pour l'histoire des Vikings et de la nostalgie pour un ensemble LEGO Vikings classique des années 1990 (7018 Le bateau des Vikings contre le monstre). Mon premier projet LEGO Ideas, Le village viking, a récolté 10 000 votes en 2020, mais n'a pas franchi les dernières étapes d'approbation.



En 2022, j'ai soumis une version plus évoluée qui a recueilli 10 000 votes quelques semaines à peine avant que la première version ne soit déclarée gagnante du concours Target™ x LEGO Ideas. En fin de compte, nous avons inclus des éléments de mes deux propositions, de sorte que l'on peut dire que vous obtenez deux modèles à 10 000 votes en un ! Nous avons peaufiné les détails, comme l'escalier de pierre, la grotte, les décorations dorées du toit et, mon préféré, le pont de corde. Le moule classique du pont de corde LEGO est l'une de mes pièces préférées de tous les temps, mais il n'est plus produit, alors nous avons créé une version en briques. Dans mes temps libres, je m'entraîne au jiu-jitsu brésilien, alors nous avons aussi caché un petit œuf de Pâques lié aux arts martiaux. Merci à chaque partisan qui a voté pour mes contributions sur LEGO Ideas, notamment dans le cadre du concours Target™ x LEGO Ideas ! »

∞ Florian (conocido como BrickHammer en la comunidad LEGO® Ideas) es alemán de nacimiento y tiene una maestría en Historia, Literatura Inglesa y Ciencias Políticas. Es un talentoso y popular colaborador de la comunidad LEGO Ideas: ¡y sus aportaciones han alcanzado más de 10.000 seguidores en ocho ocasiones hasta la fecha! De hecho, Florian eligió la conquista normanda de Inglaterra de 1066 y su influencia en la sociedad anglosajona como tema principal para uno de sus exámenes finales en la universidad.

"Si bien este set no aspira a representar con realismo un poblado vikingo (por mencionar un ejemplo, los cascos tienen cuernos que son 100 % ficticios), la inspiración para el proyecto provino de una combinación de mi interés por la historia vikinga y la nostalgia por un set LEGO Vikings clásico de los años 90 (Viking Ship Challenges the Midgard Serpent [7018]). Mi primer proyecto del Poblado Vikingo LEGO Ideas alcanzó los

10.000 votos en 2020, pero no llegó a las rondas finales de aprobación. En 2022, presenté una versión más evolucionada y actualizada que, casualmente, alcanzó los 10.000 votos apenas unas semanas antes de que la primera versión fuera anunciada como ganadora del concurso Target™ x LEGO Ideas. Al final, incluimos elementos de ambas propuestas, ¡así que se puede decir que son dos modelos con 10.000 votos en uno! Perfeccionamos detalles como la escalera de piedra, la cueva, los adornos dorados del techo y, mi preferido, ¡el puente de cuerdas! El molde clásico del puente de cuerdas LEGO es una de mis piezas favoritas de todos los tiempos, pero, como ya no se fabrica, decidimos crear una versión a partir de bricks. En mi tiempo libre, practico el *jiu-jitsu* brasileño, así que también escondimos un pequeño huevo de Pascua de artes marciales. Agradezco a todos y cada uno de los seguidores que votaron por mis propuestas en LEGO Ideas, especialmente en el concurso Target™ x LEGO Ideas".



MEET THE LEGO® DESIGNERS

RENCONTRE AVEC LES CONCEPTEURS LEGO®

CONOCE A LOS DISEÑADORES DE LEGO®

∞ "Vikings have always sparked our imagination, and Florian did a fabulous job capturing the Viking aesthetic. We altered the model composition, so it offers a great front view, with lots of interesting details to discover on every side. The structure of the chieftain's longhouse is based on actual Viking timber architecture – a fire pit provides heat and a place to cook, and the decorated tile with wood carvings adds the perfect finishing touch. You can use the bellows to stoke the forge fire, and the blacksmith has a paintbrush ready to decorate her new shield. There is even a pickaxe, which can be used to mine iron from the cave under the tower. And keen LEGO® fans may notice the significance of the village banners' colors. This was absolutely a passion project for Florian, Johanna and me. We hope you enjoy the final result!"

–Isaac Snyder, LEGO® Ideas Model Designer

∞ « Les Vikings ont toujours stimulé notre imagination, et Florian a magnifiquement réussi à reproduire l'esthétique viking. Nous avons modifié la composition du modèle afin de présenter une superbe vue de face, avec de nombreux détails intéressants à découvrir de tous les côtés. La structure de la maison longue du chef s'inspire de l'architecture en bois des Vikings. Un foyer permet de se réchauffer et de cuisiner, et les tuiles décorées de sculptures en bois ajoutent la touche finale parfaite. Vous pouvez utiliser le soufflet pour alimenter le feu de la forge, et le forgeron dispose d'un pinceau prêt à décorer son nouveau bouclier. Il y a même une pioche, qui peut être utilisée pour extraire du fer de la grotte située sous la tour. Les amateurs passionnés de LEGO® remarqueront peut-être l'importance des couleurs des bannières du village. Ce projet était une véritable passion pour Florian, Johanna et moi-même. Nous espérons que vous apprécierez le résultat final ! »

–Isaac Snyder, concepteur de modèles LEGO® Ideas

"Both of Florian's models really express how I imagined Vikings when I was a child. Strong, adventurous and a bit magical! I always felt empowered by this world, so I wanted the minifigure characters to exude this feeling. Although not all the graphics in the final model are historically faithful, they are all heavily inspired by the Viking culture. We wanted the model to inspire storytelling and find a nice balance between history and fiction. The motifs on the shields are inspired by animal pairs from Viking mythology, and I especially love how the chieftain's shield turned out with the wolves. In LEGO Ideas, the fan designer is always the star of the model, so we included a small Easter egg for 'BrickHammer' in the blacksmith's hut. See if you can find his runic initials!"

–Johanna Wurm Jensen, LEGO® Ideas Graphic Designer

« Les deux modèles de Florian reflètent vraiment la façon dont j'imaginai les Vikings lorsque j'étais enfant. Costauds, aventureux et un peu magiques ! Ce monde m'a toujours inspiré un sentiment de puissance; c'est pourquoi je voulais que les figurines en soient imprégnées. Bien que tous les éléments graphiques du modèle final ne soient pas historiquement fidèles, ils sont tous fortement influencés par la culture viking. Nous voulions que le modèle soit source de récits et présente un bon équilibre entre l'histoire et la fiction. Les motifs des boucliers évoquent les paires d'animaux de la mythologie viking, et j'aime particulièrement le rendu du bouclier du chef avec les loups. Avec LEGO Ideas, le concepteur amateur est toujours la vedette du modèle; c'est pourquoi nous avons intégré un petit œuf de Pâques pour « BrickHammer » dans la cabane du forgeron. Voyez si vous pouvez trouver ses initiales runiques ! »

–Johanna Wurm Jensen, graphiste LEGO® Ideas



Isaac Snyder

Johanna Wurm Jensen

“Los vikingos siempre han echado a volar nuestra imaginación, y Florian hizo un fantástico trabajo capturando la estética vikinga. Modificamos la composición del modelo para que ofreciera una gran vista frontal, con montones de detalles interesantes que descubrir por todos los ángulos. La estructura de la larga casa del jerarca está inspirada en la arquitectura de los edificios de madera vikingos de verdad: por un lado, tiene un fogón que proporciona calor y sirve para cocinar y, como toque final, ¡está decorada con baldosas que representan tablones de madera con relieves ornamentales! Puedes usar el fuelle para avivar el fuego de la forja, y el herrero tiene un pincel listo para decorar el nuevo escudo. También hay un pico que puede usarse para extraer hierro de una cueva que está debajo de la torre. Además, los verdaderos fans de LEGO® no podrán pasar por alto el significado de los colores de los estandartes de este poblado. Este proyecto fue una experiencia apasionante tanto para Florian como para Johanna y para mí. Esperamos que te guste el resultado”.

–Isaac Snyder, modelista de LEGO® Ideas

“Los dos modelos de Florian expresan con toda precisión cómo me imaginaba a los vikingos cuando era una niña: ¡fuertes, aventureros y un poco mágicos! Este mundo siempre me hizo sentir empoderada y, por tal motivo, en todo momento me esforcé por hacer que los personajes de las minifiguras irradian esa sensación. Aunque no todos los elementos gráficos del modelo final representan la historia con fidelidad, todos están muy inspirados en la cultura vikinga. Lo que buscábamos era que el modelo inspirara la narración de historias y encontrar un equilibrio adecuado entre la historia y la ficción. Los motivos de los escudos están inspirados en parejas de animales de la mitología vikinga. Mi favorito es el del jerarca, que tiene unos lobos. En LEGO Ideas, el fan diseñador es siempre la estrella del modelo. Por eso, incluimos un pequeño huevo de Pascua dedicado a BrickHammer en la cabaña del herrero. ¡Te desafiamos a encontrar sus iniciales representadas con runas!”.

–Johanna Wurm Jensen, diseñadora gráfica de LEGO® Ideas

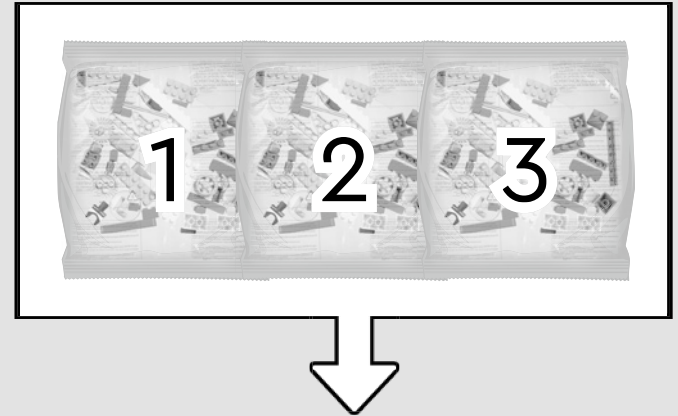
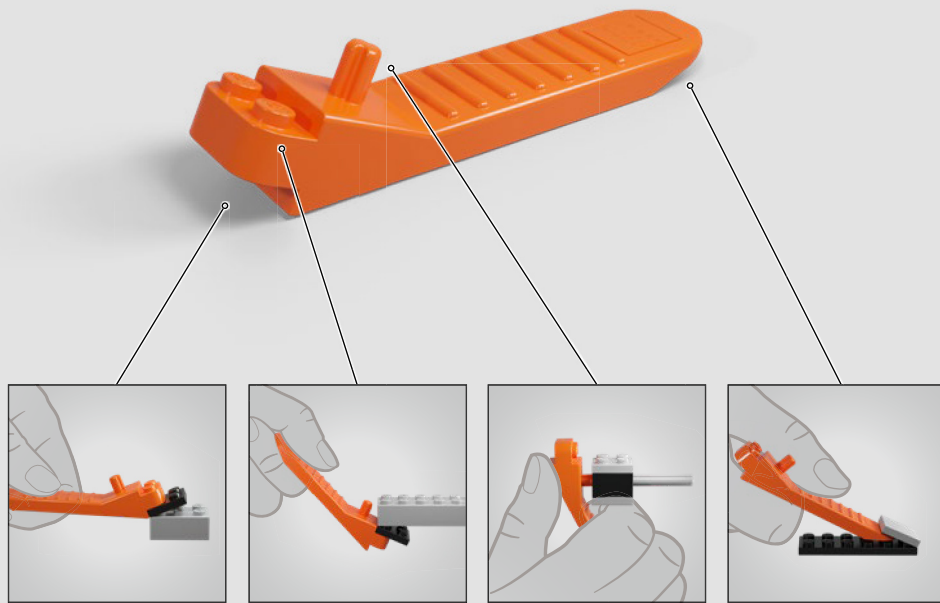

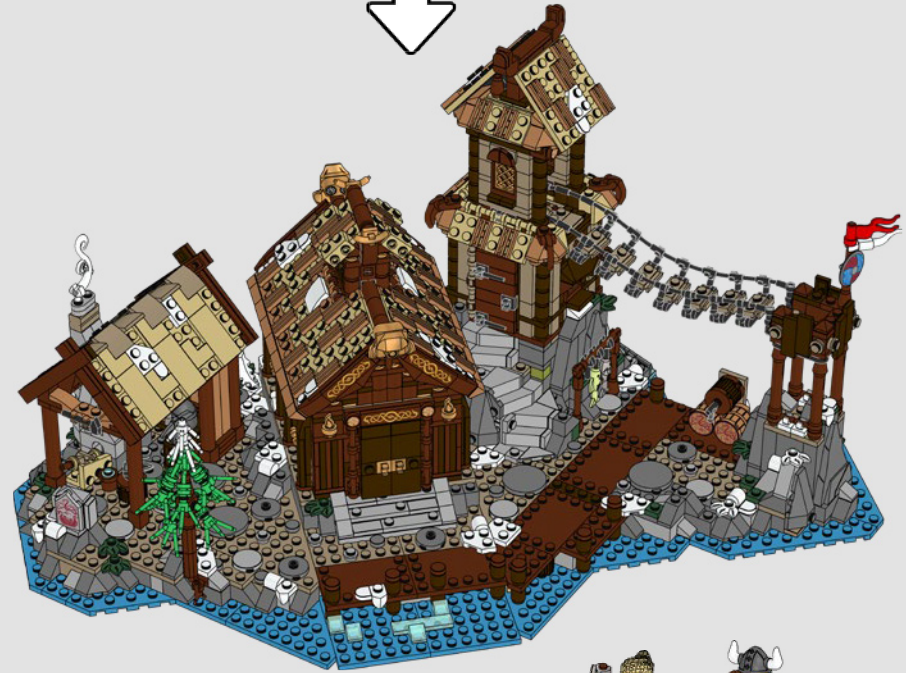
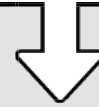
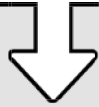
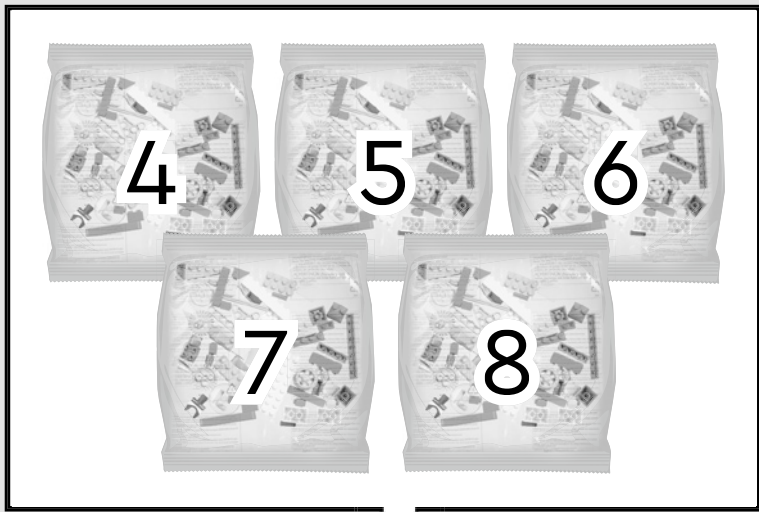

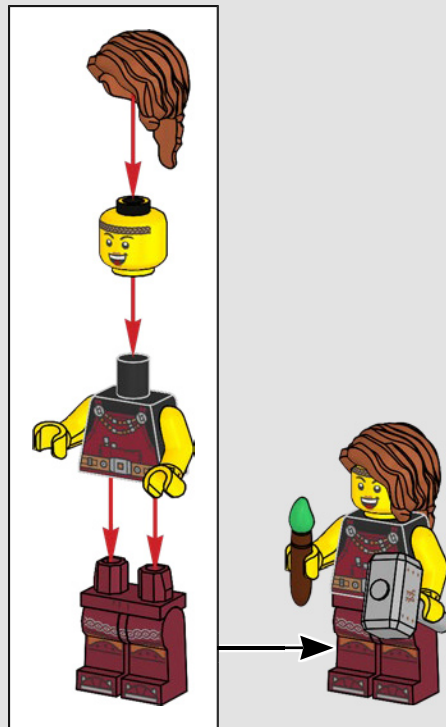
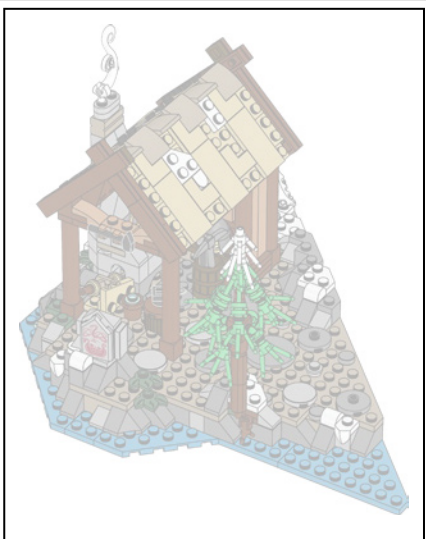

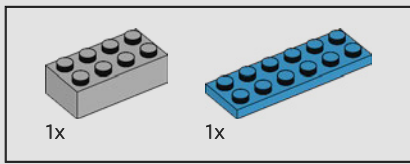

1

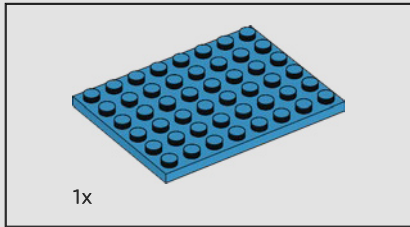
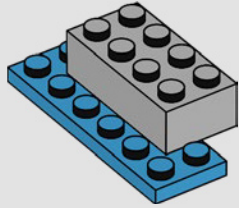

2

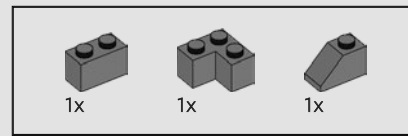
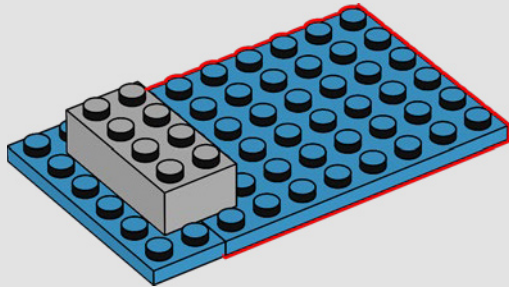

3

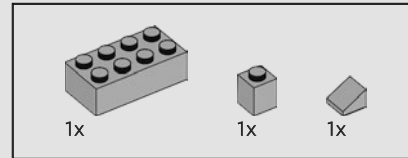
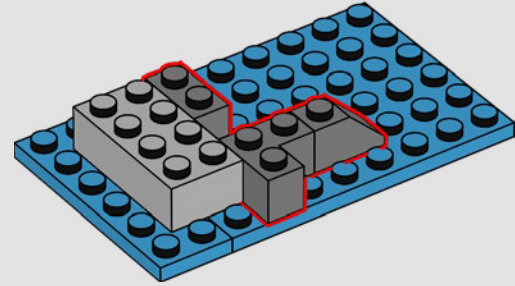

4

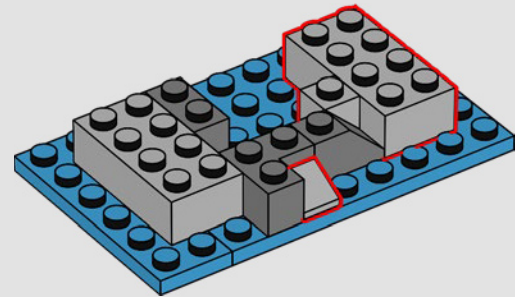

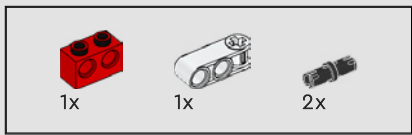

5

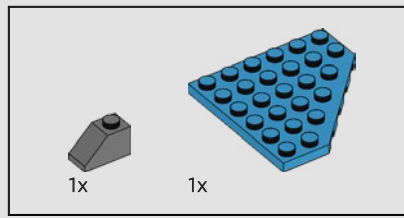
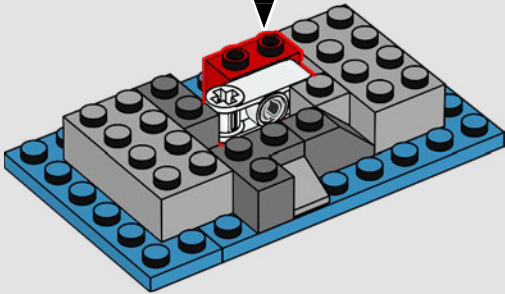
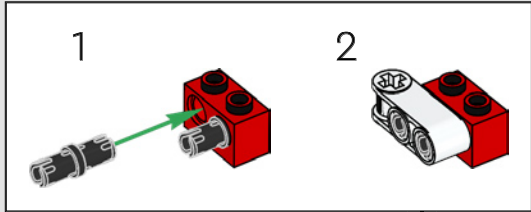

6

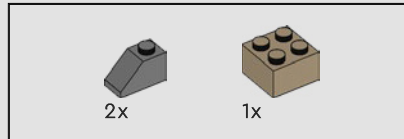
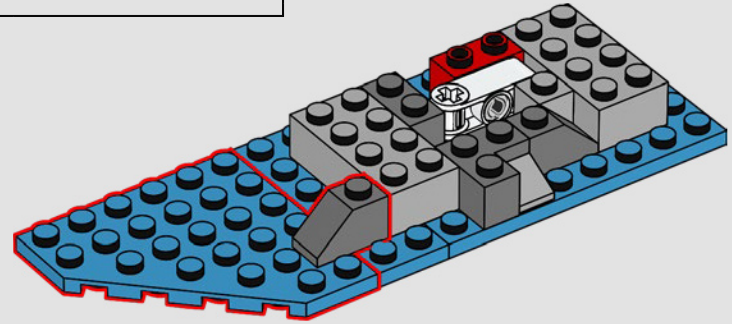

7

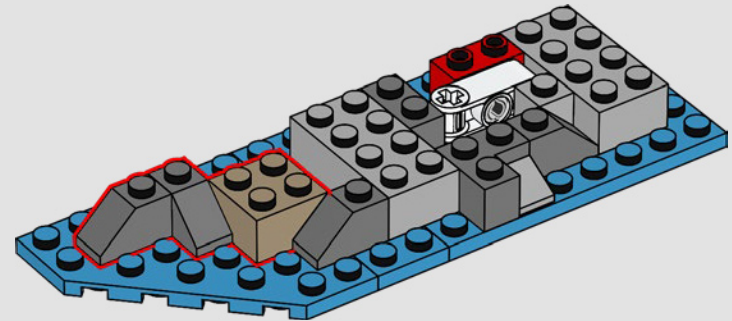

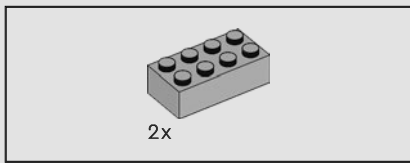

8

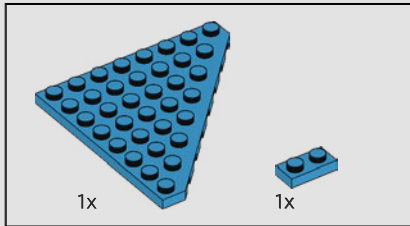
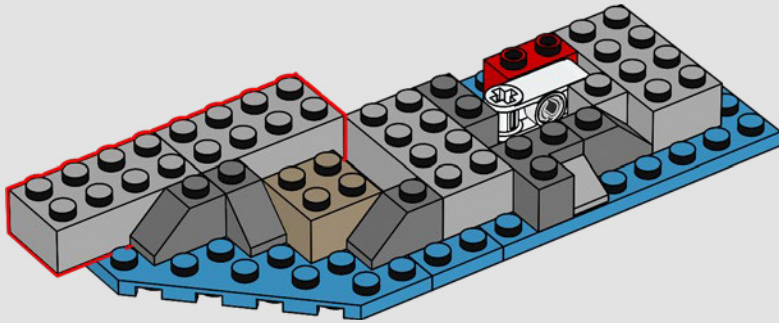

9

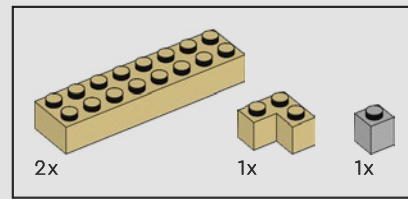
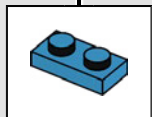
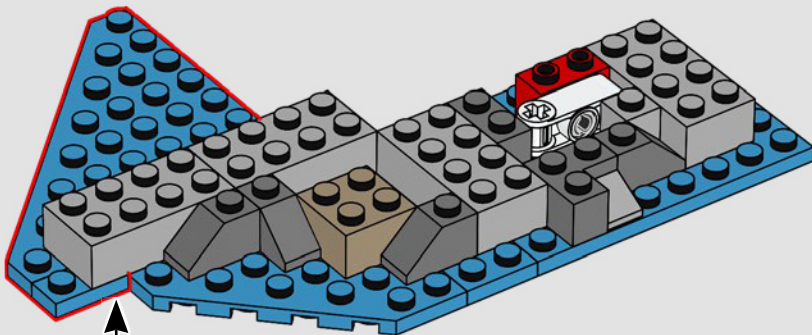

10

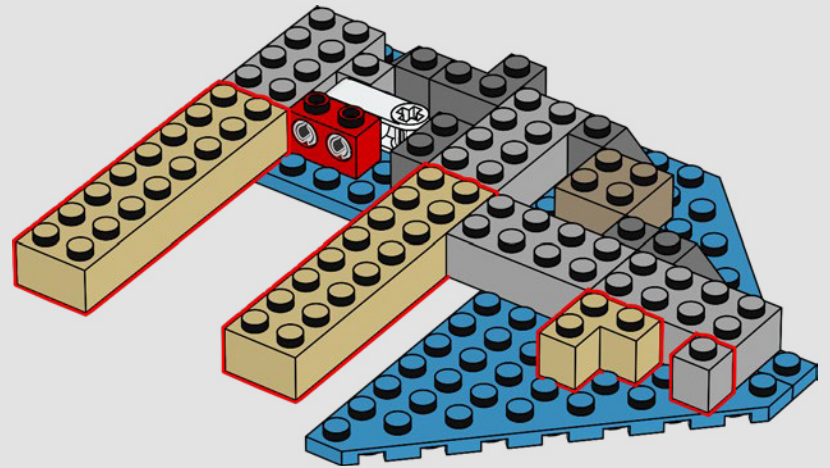
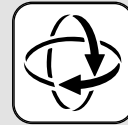

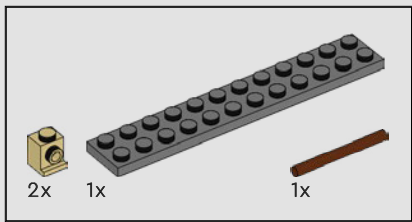

11

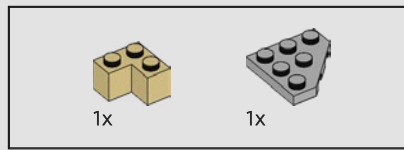
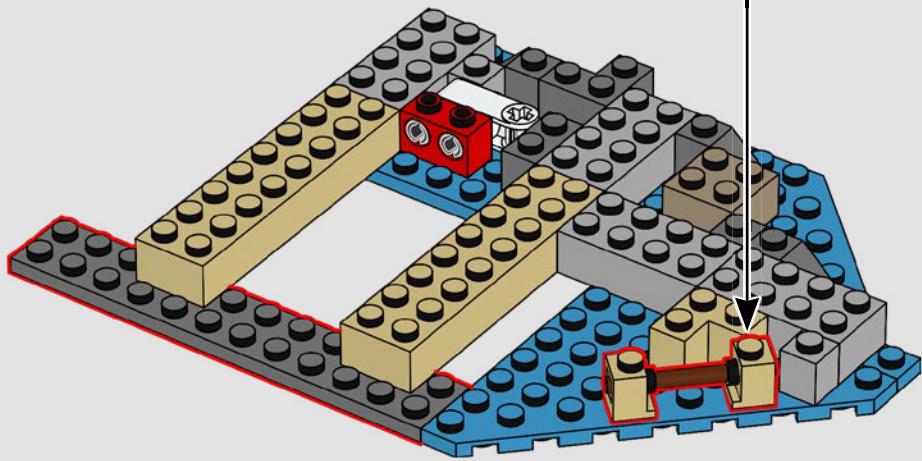
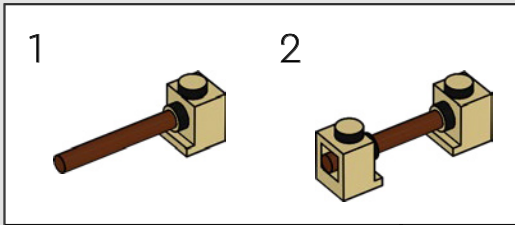

12

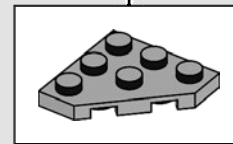
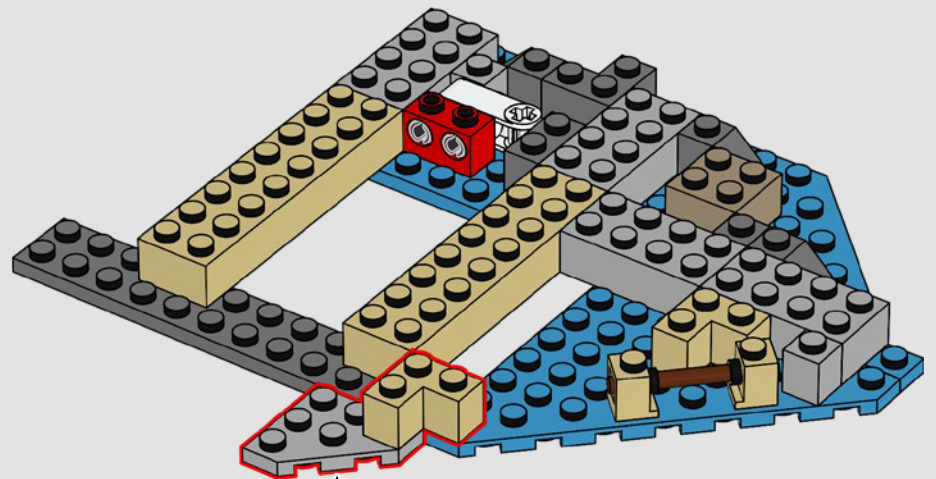

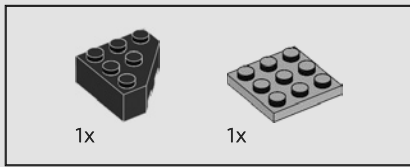

13

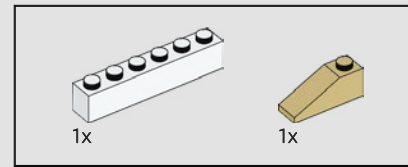
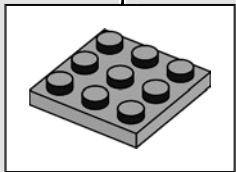
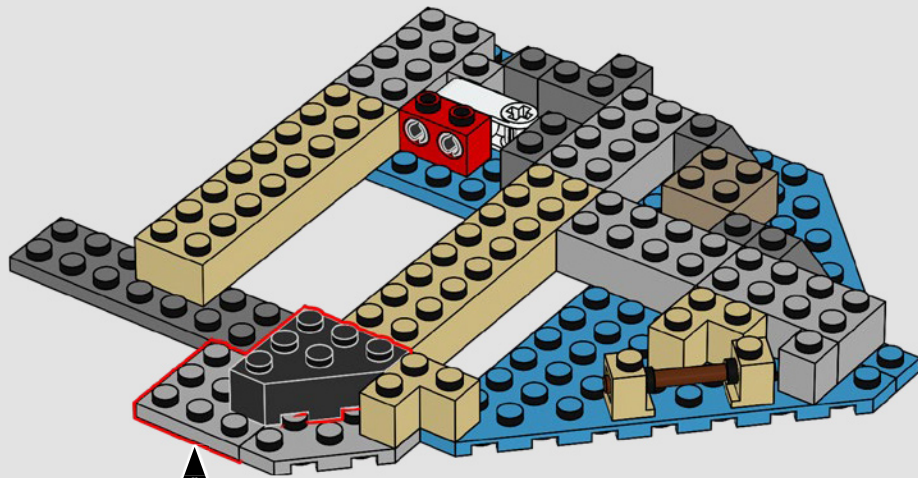

14

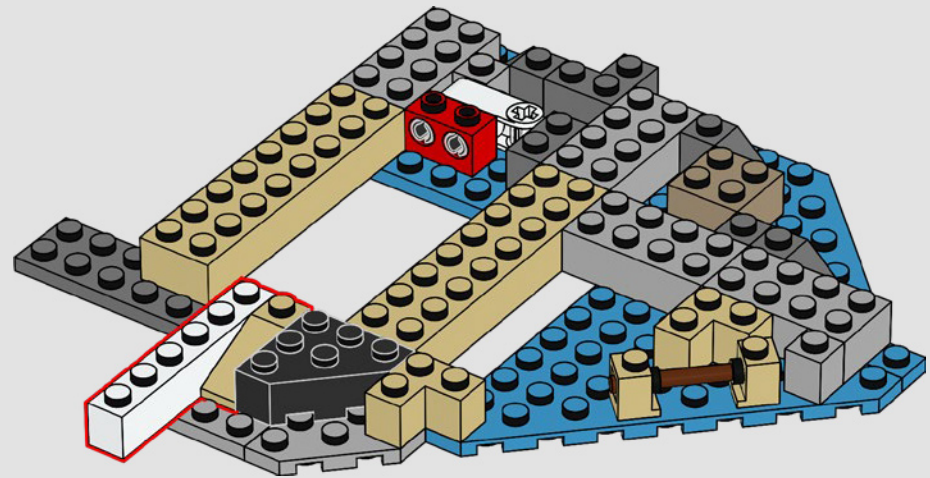

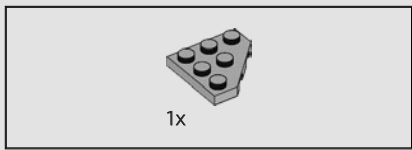

15

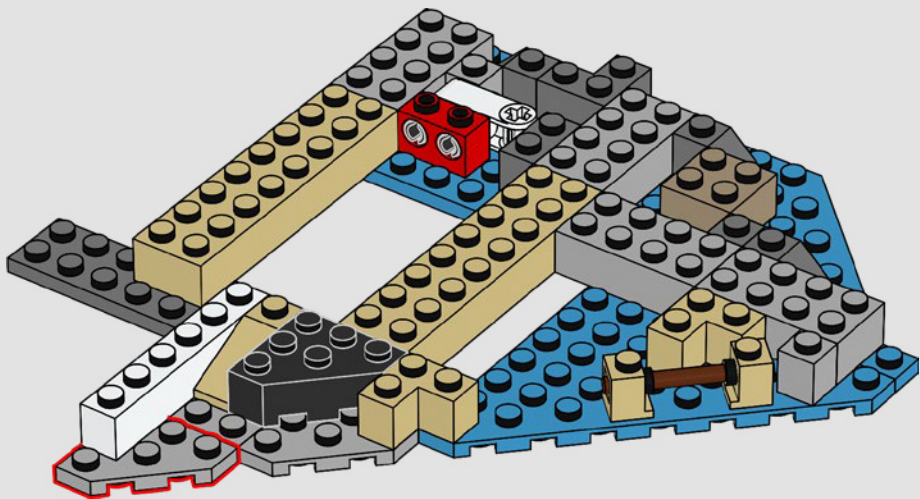

16

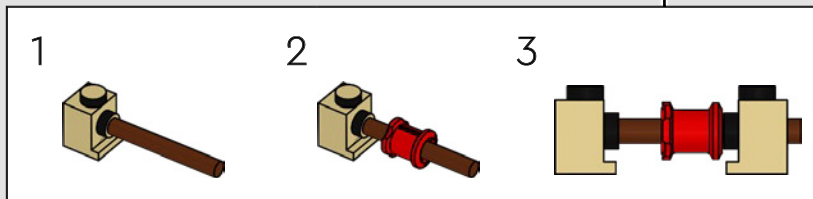
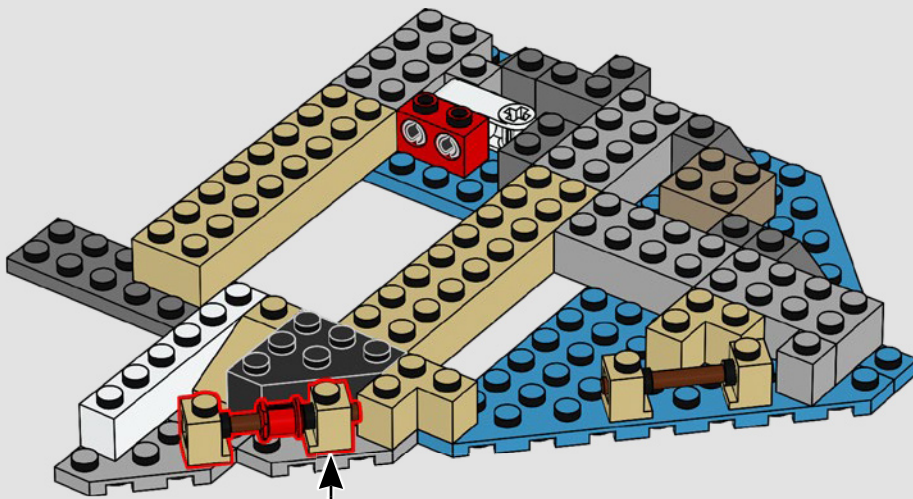

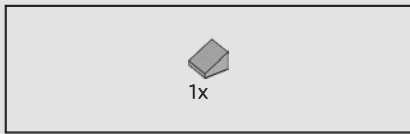

17

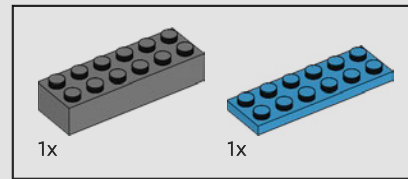
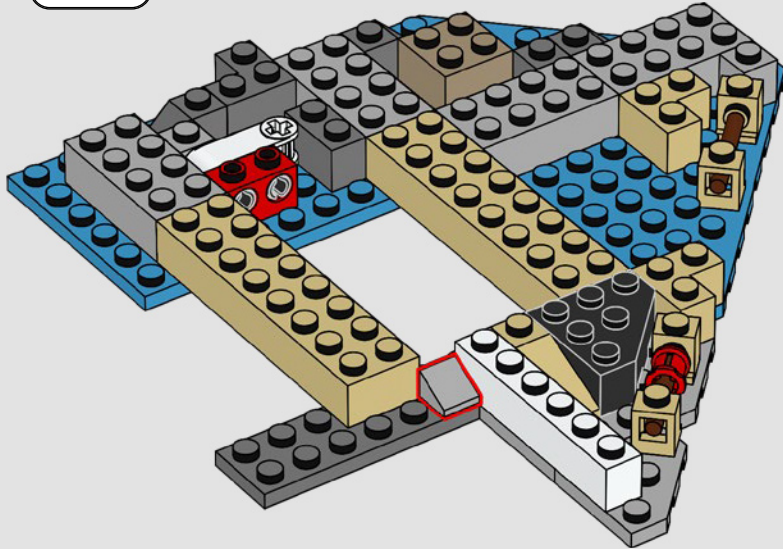

18

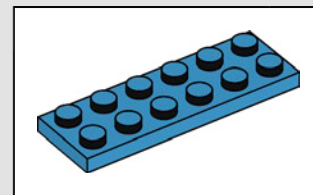
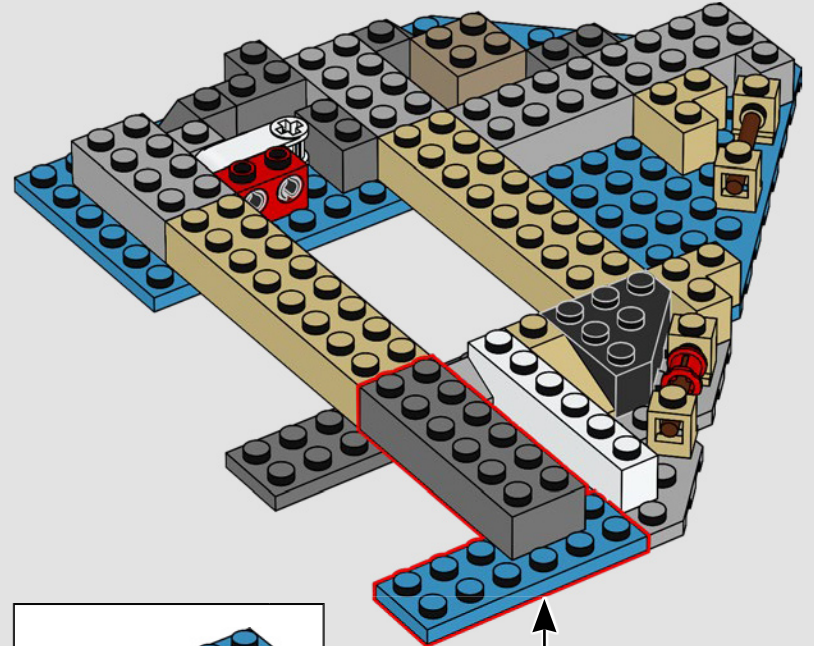

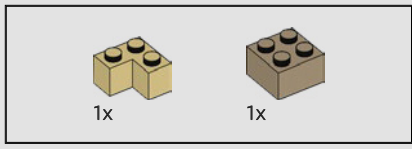

19

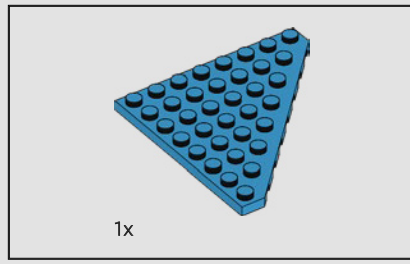
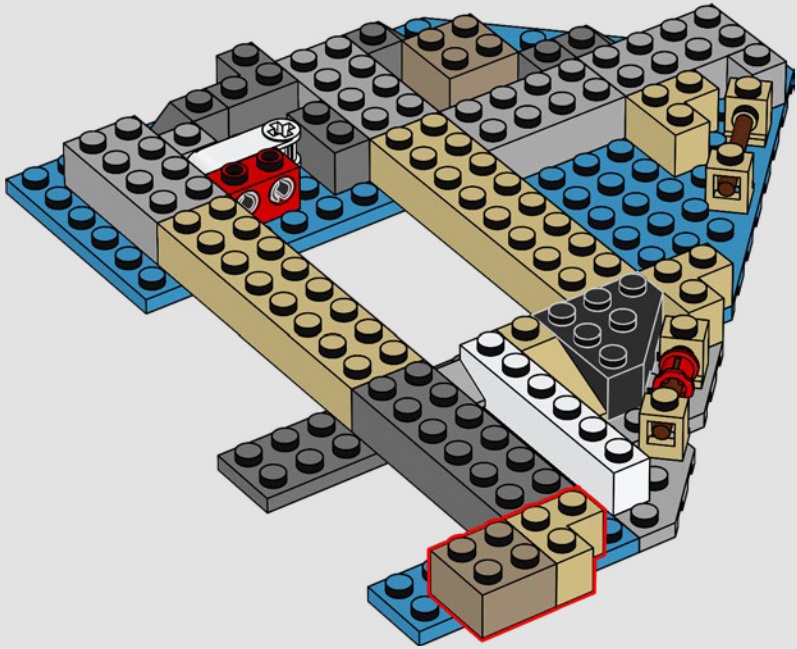

20

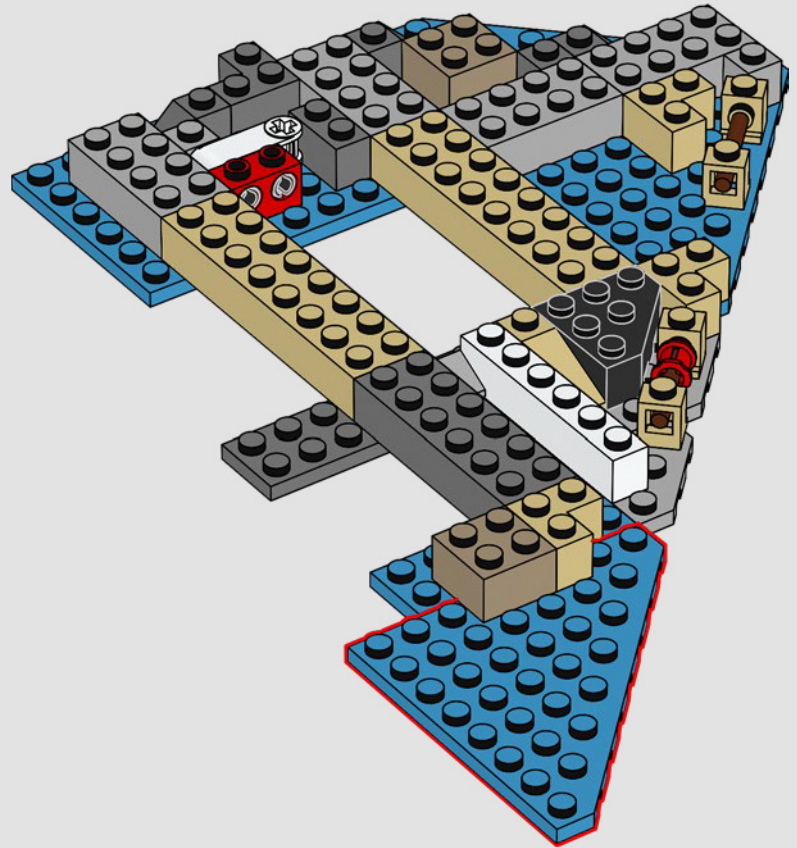



21

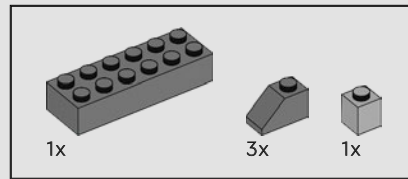
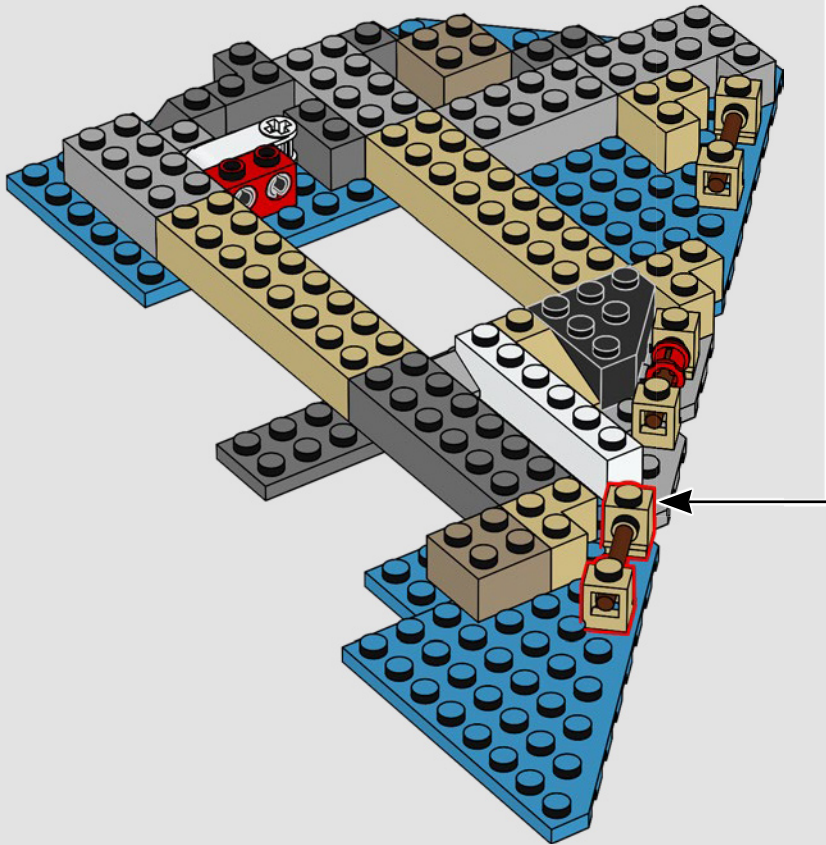
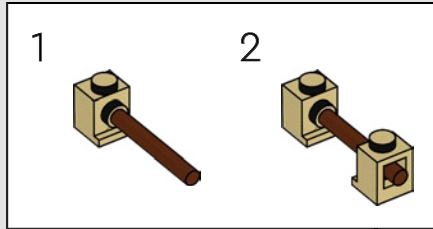

22

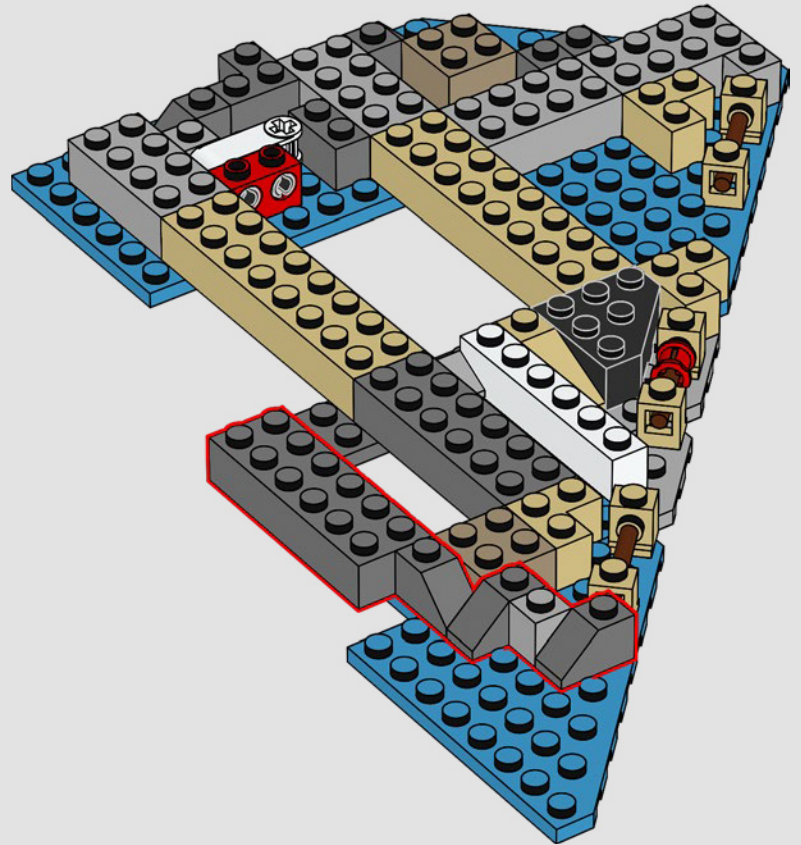

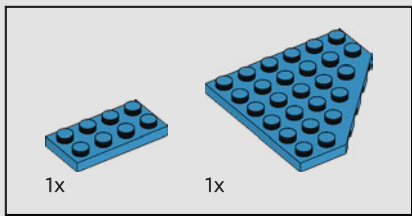

23

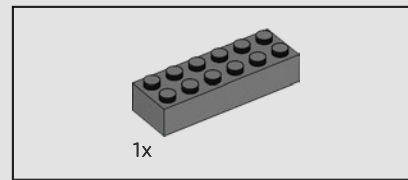
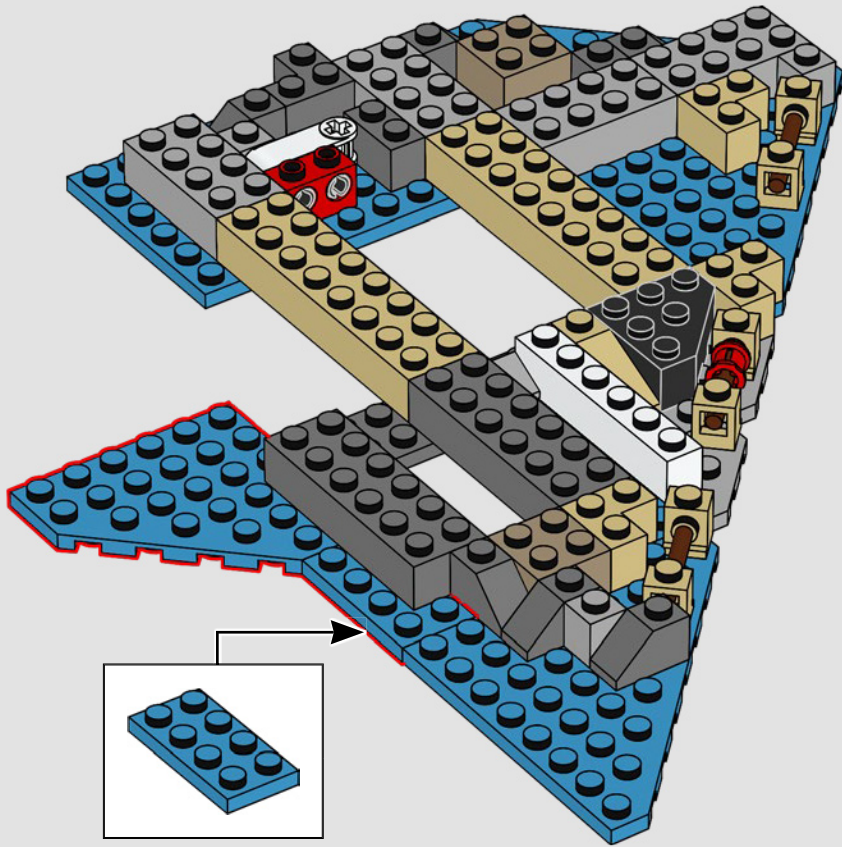

24

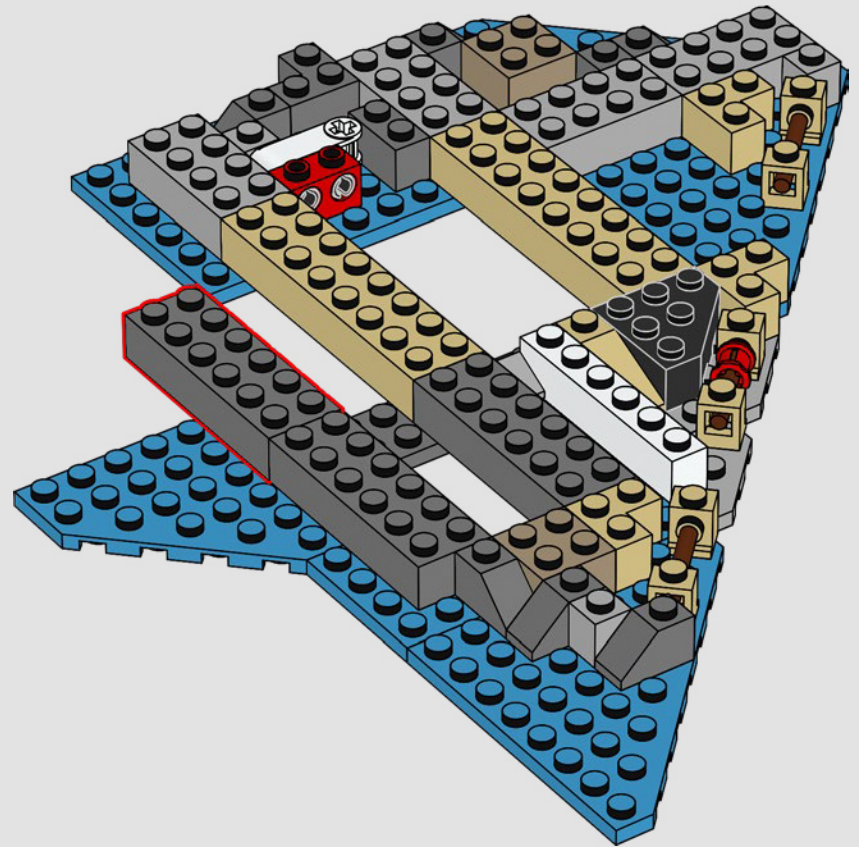

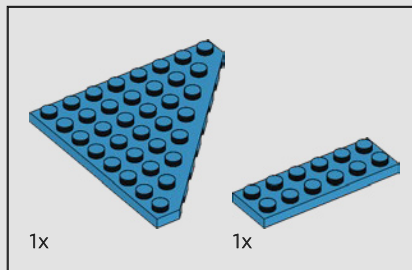

25

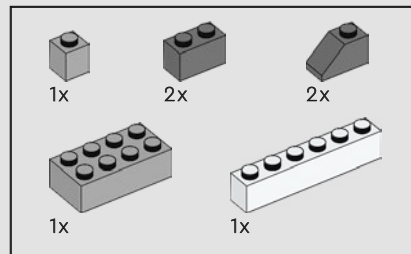
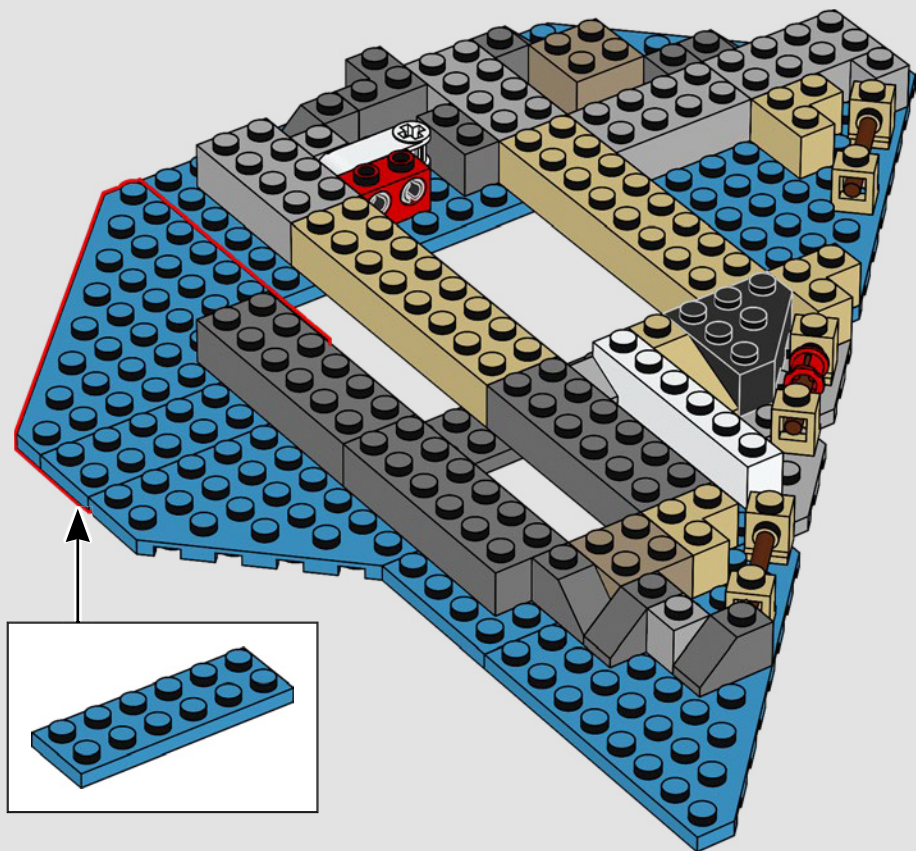

26

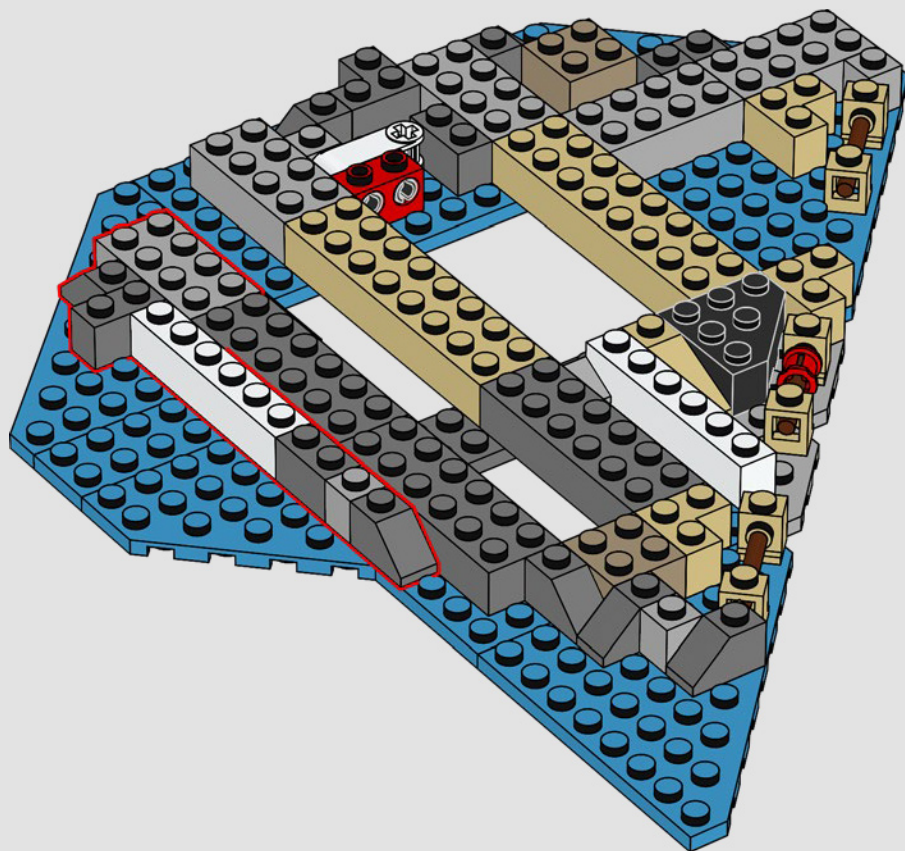

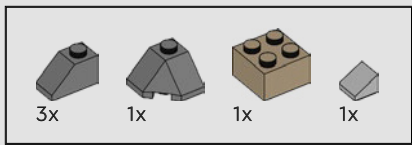

27

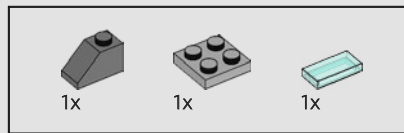
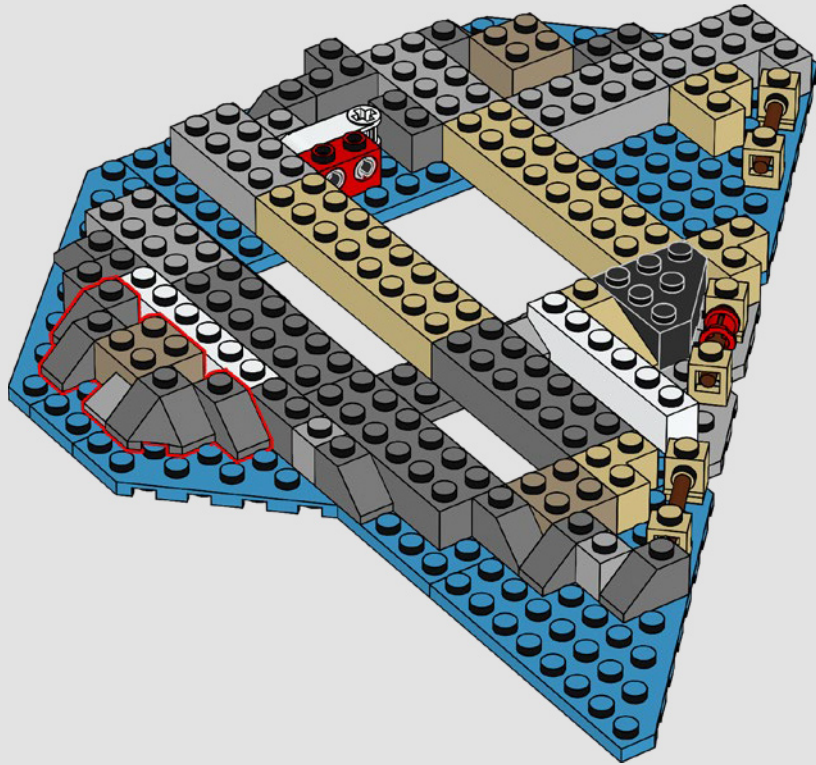

28

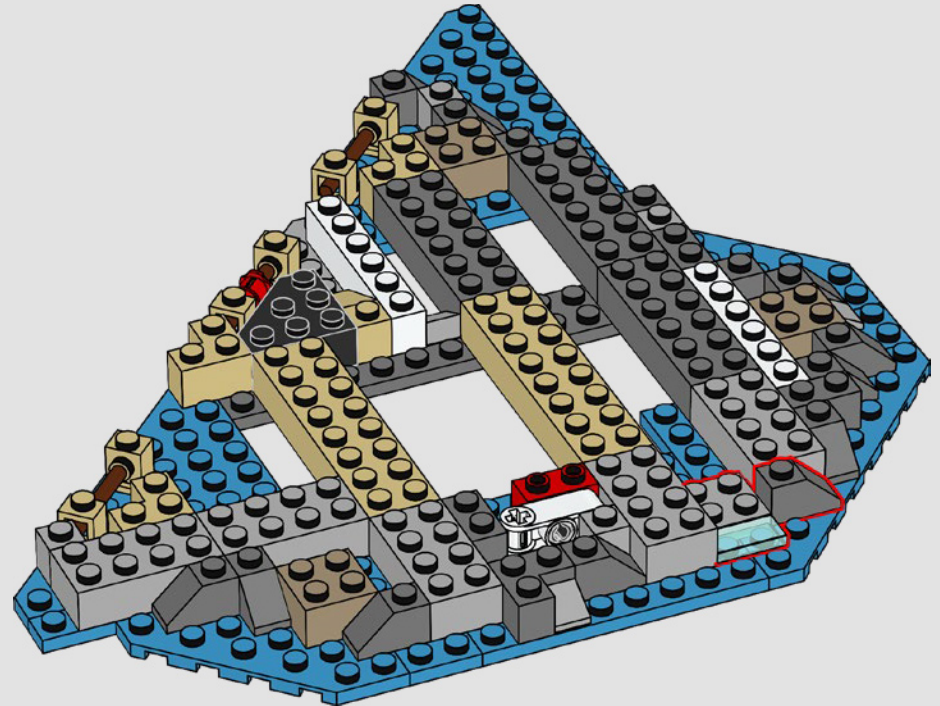
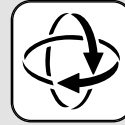



29

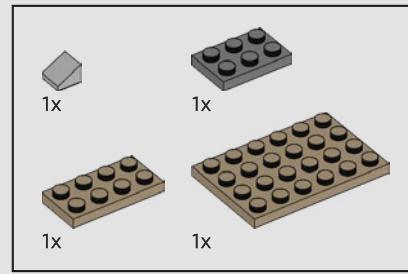
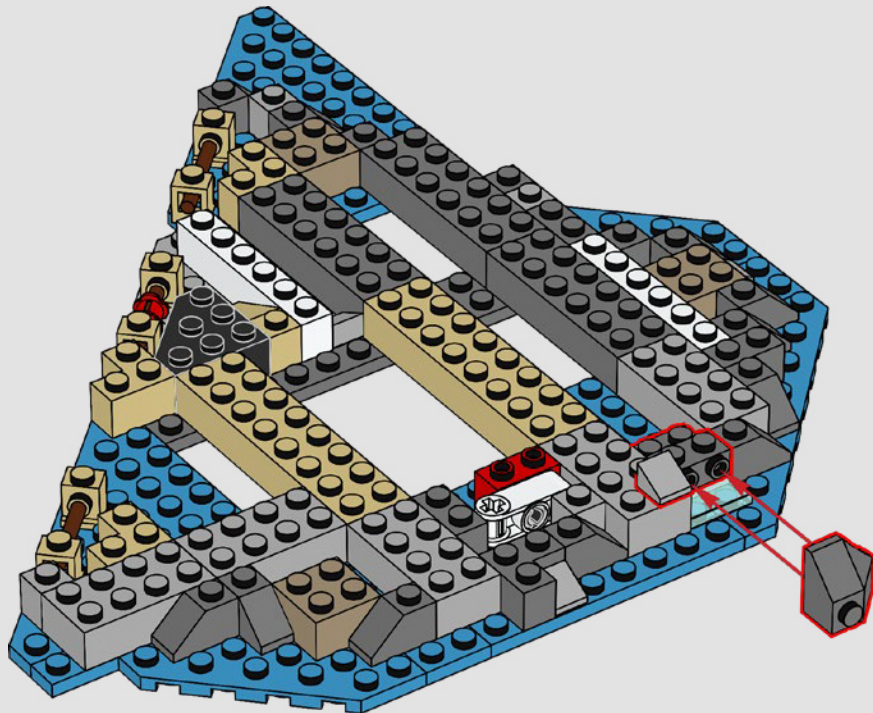

30

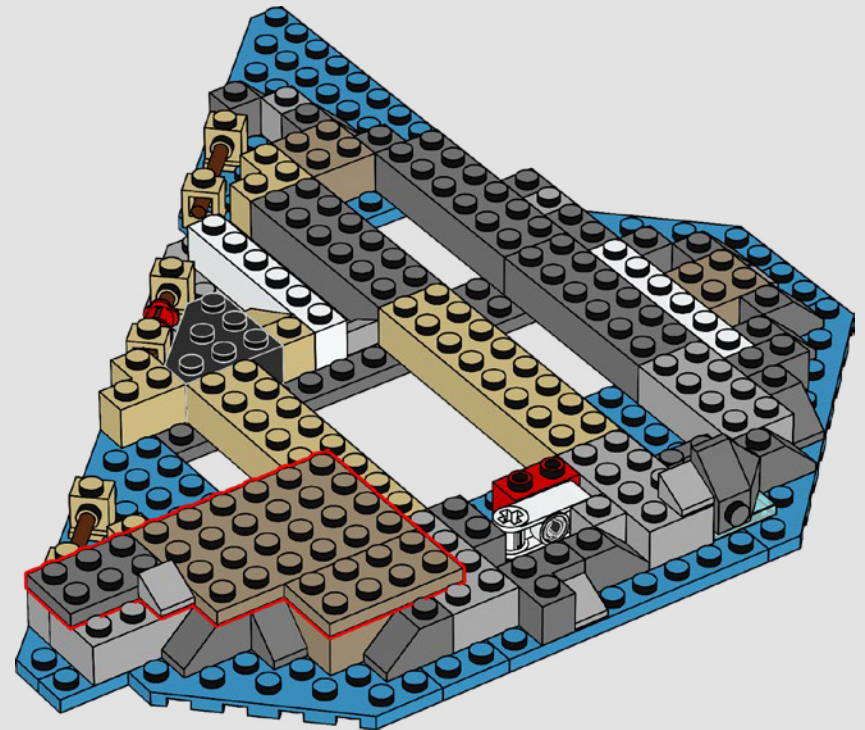

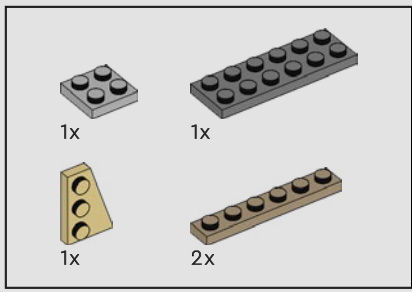

31

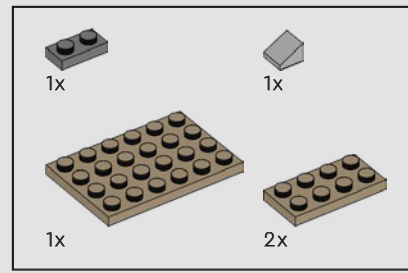
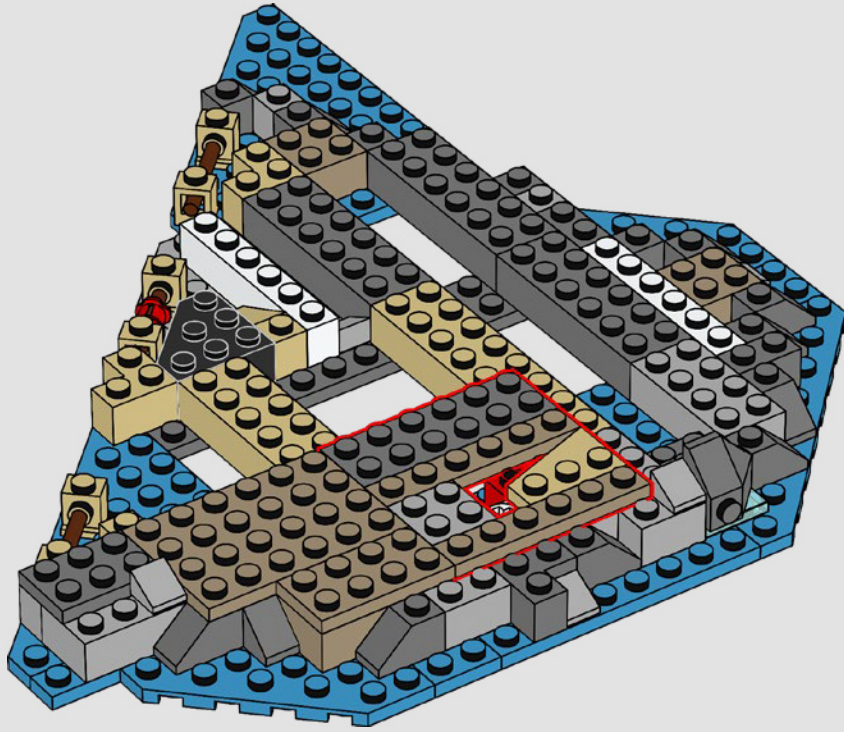

32

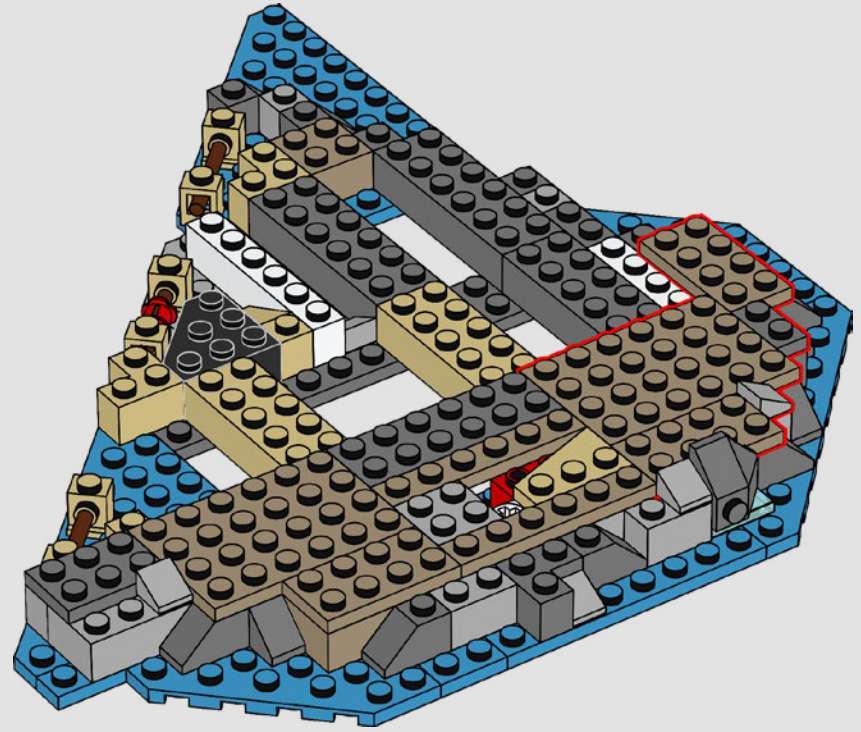

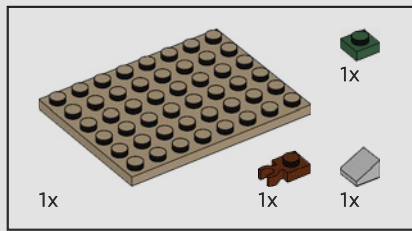

33

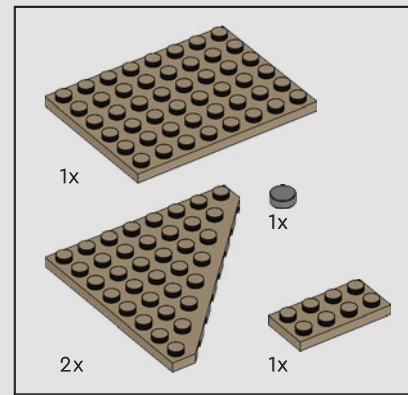
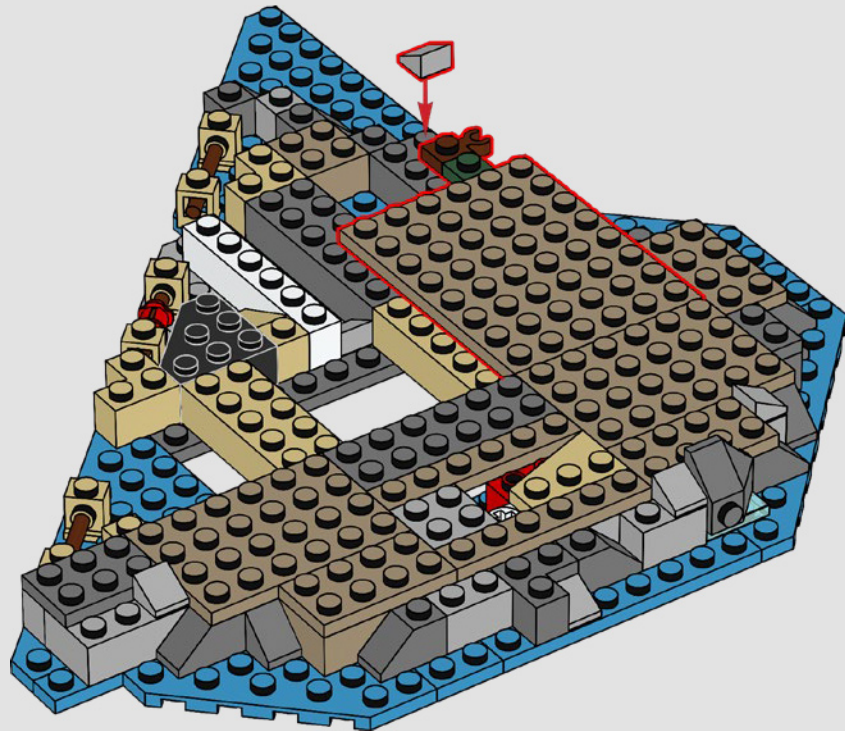

34

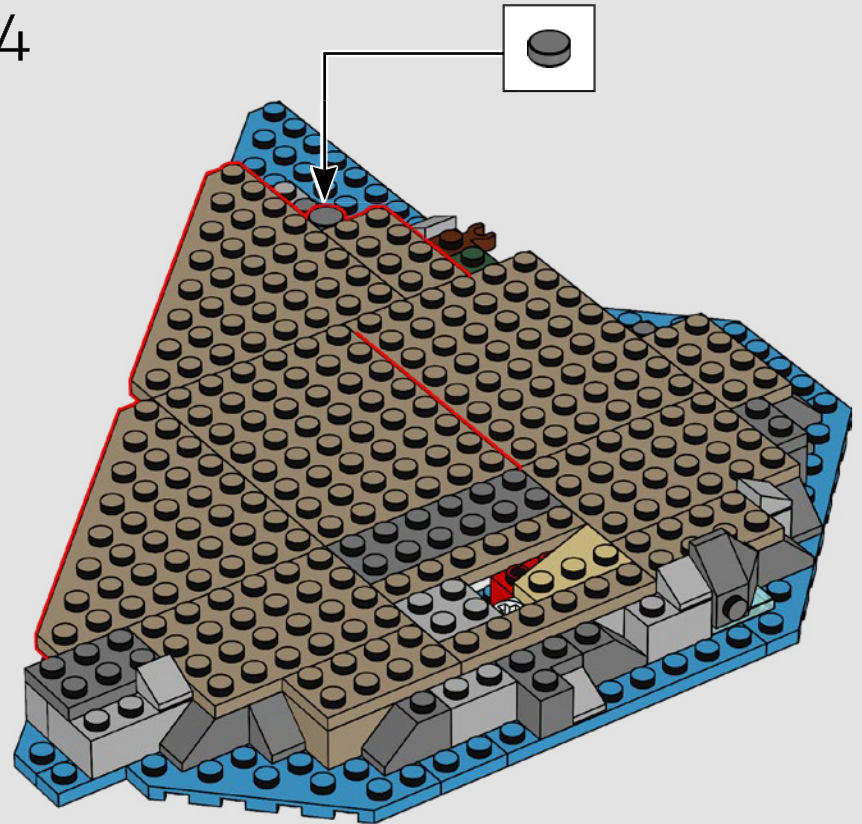

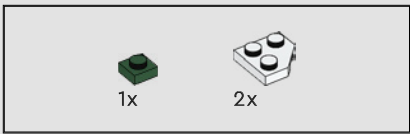

35

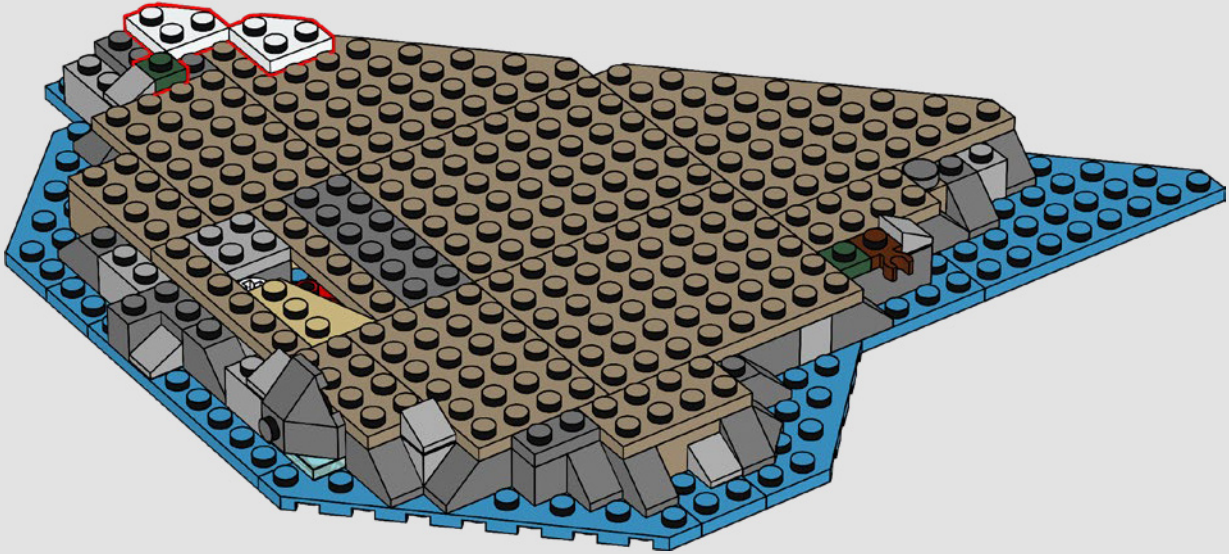

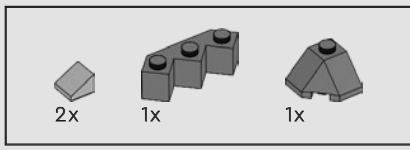

36

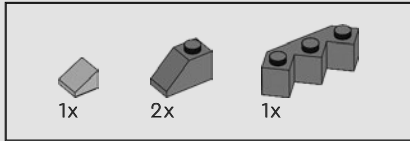
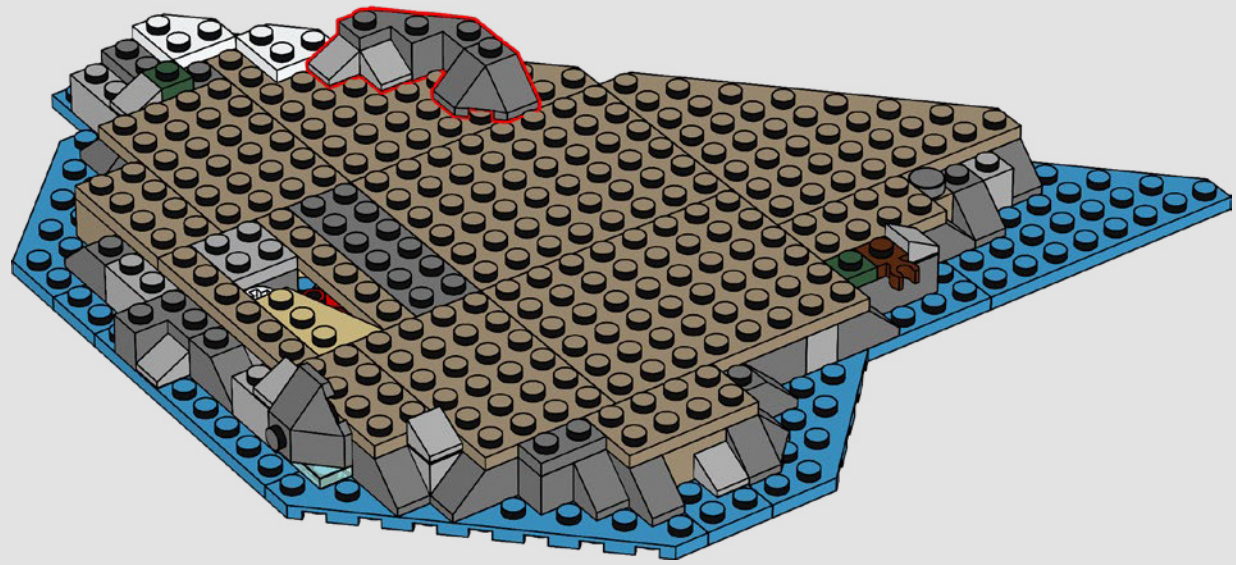

37

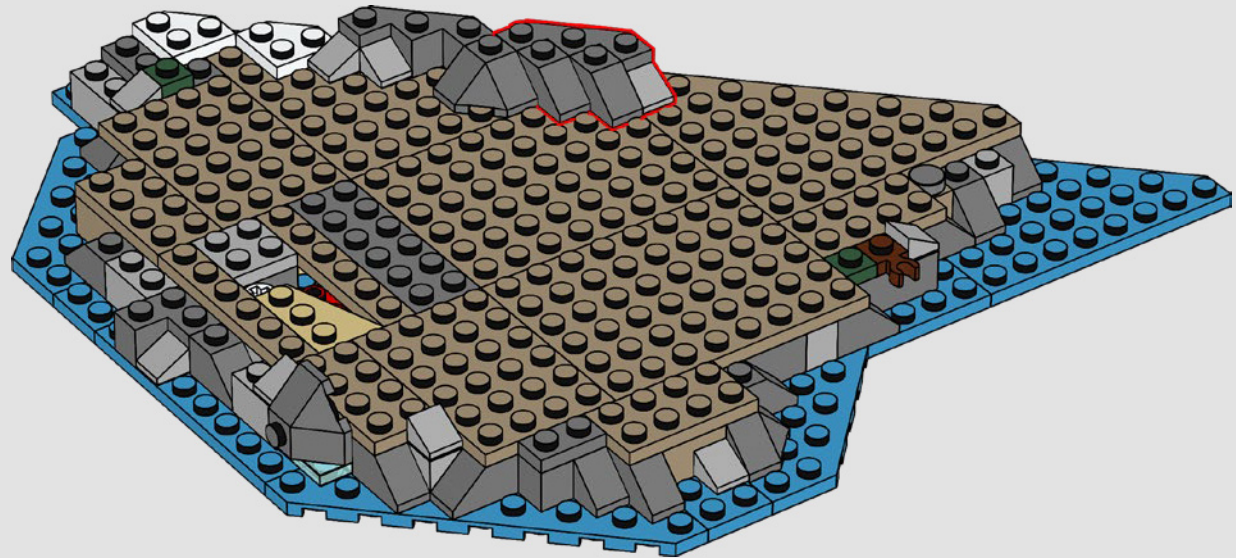



38

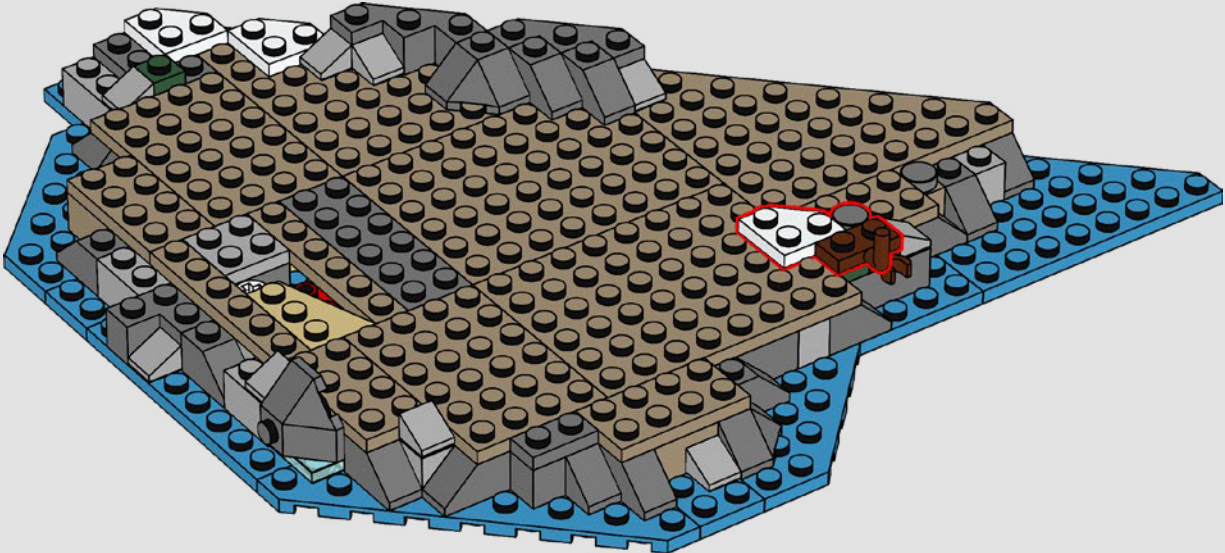

39

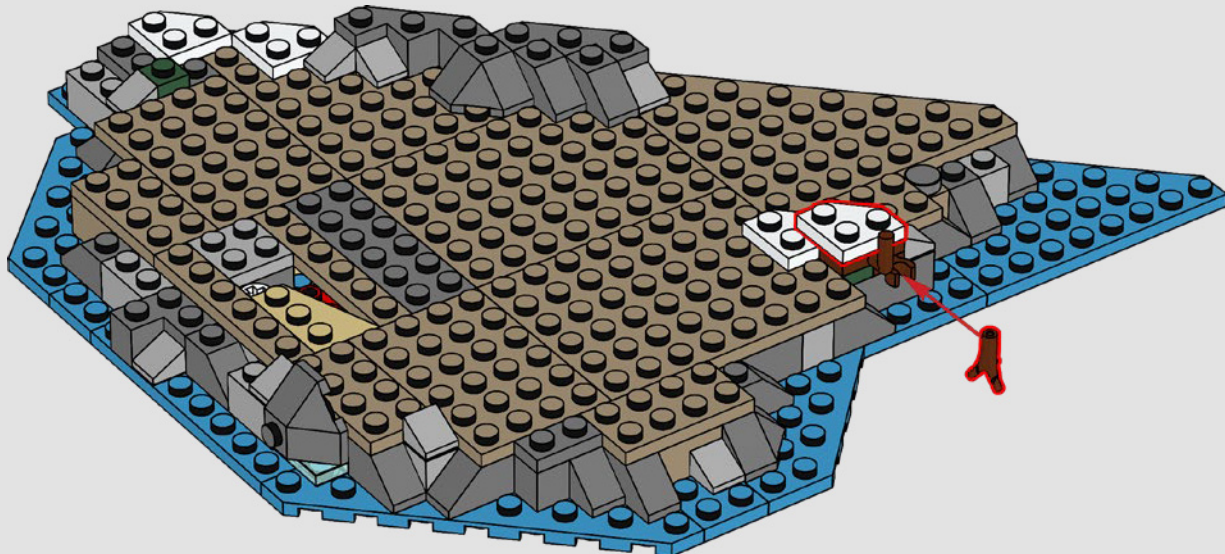



40

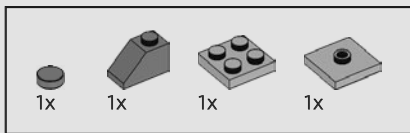
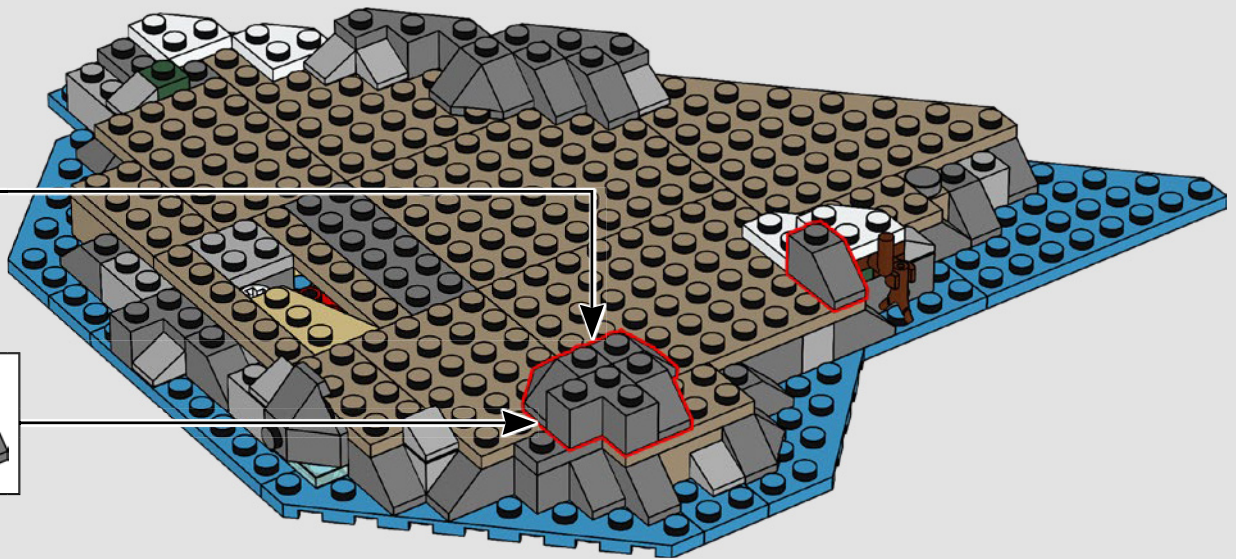
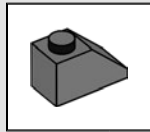

41

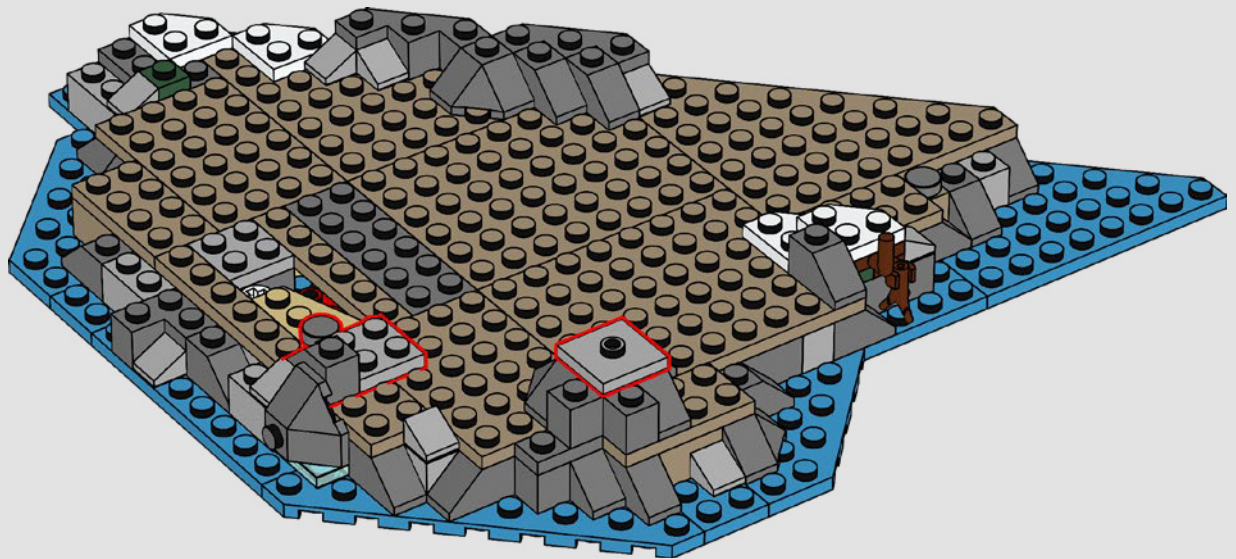

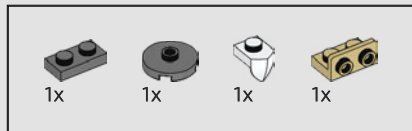

42

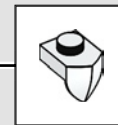
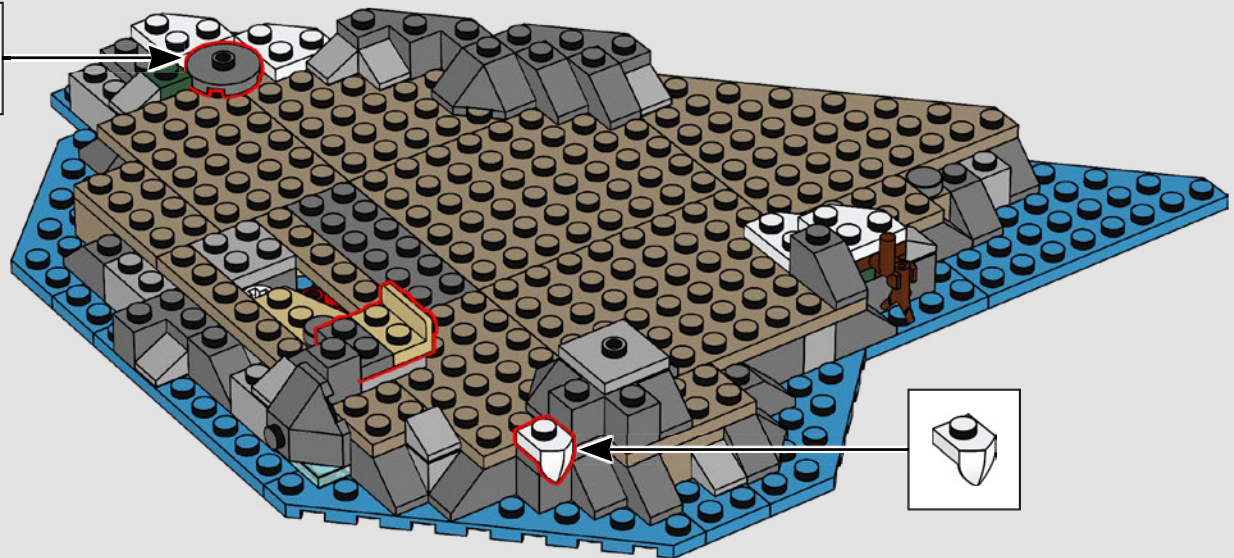
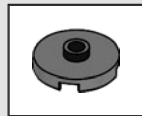

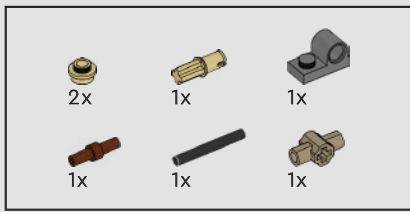

43

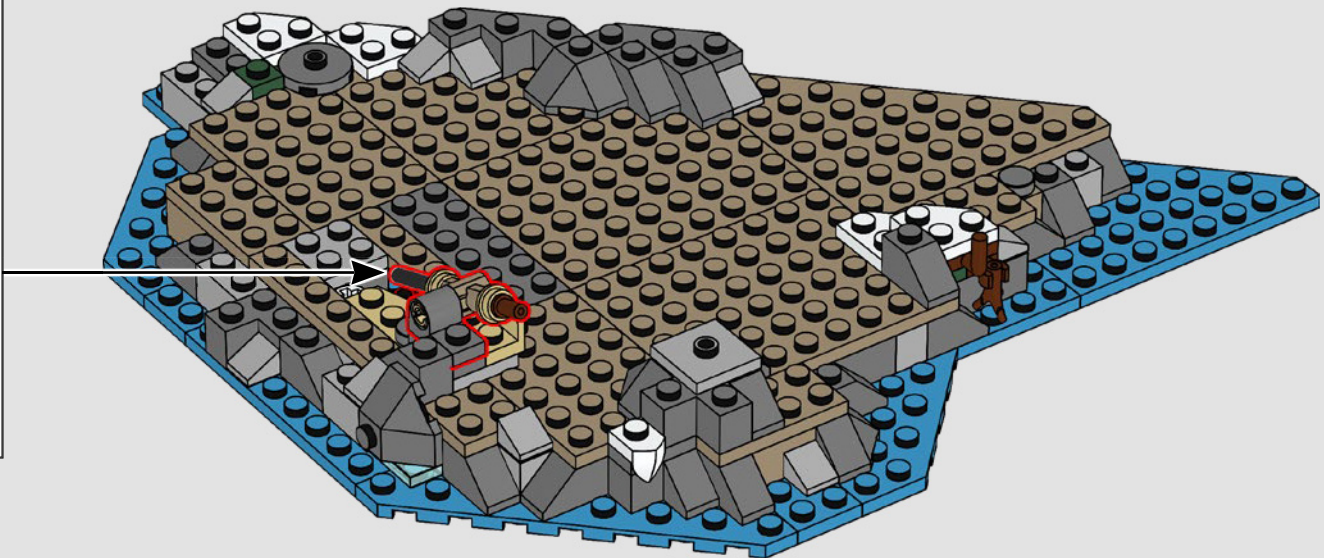
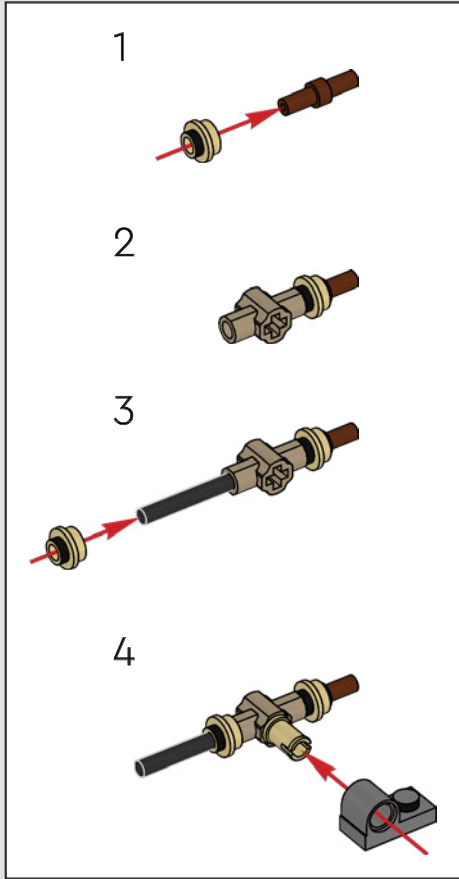

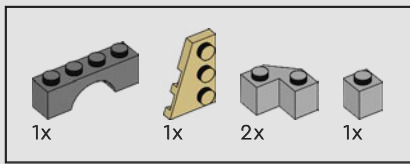

44

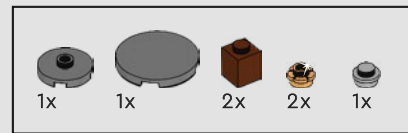
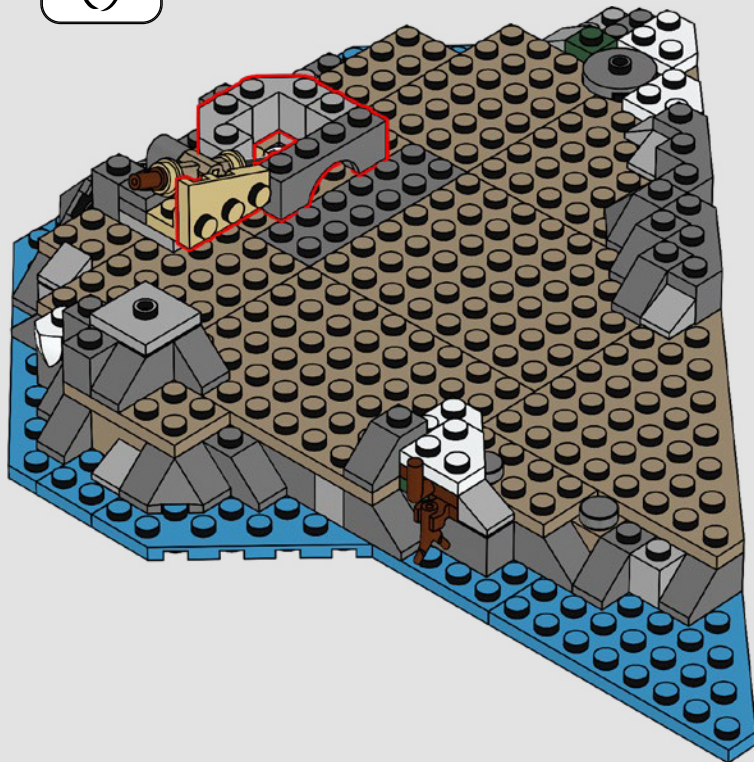

45

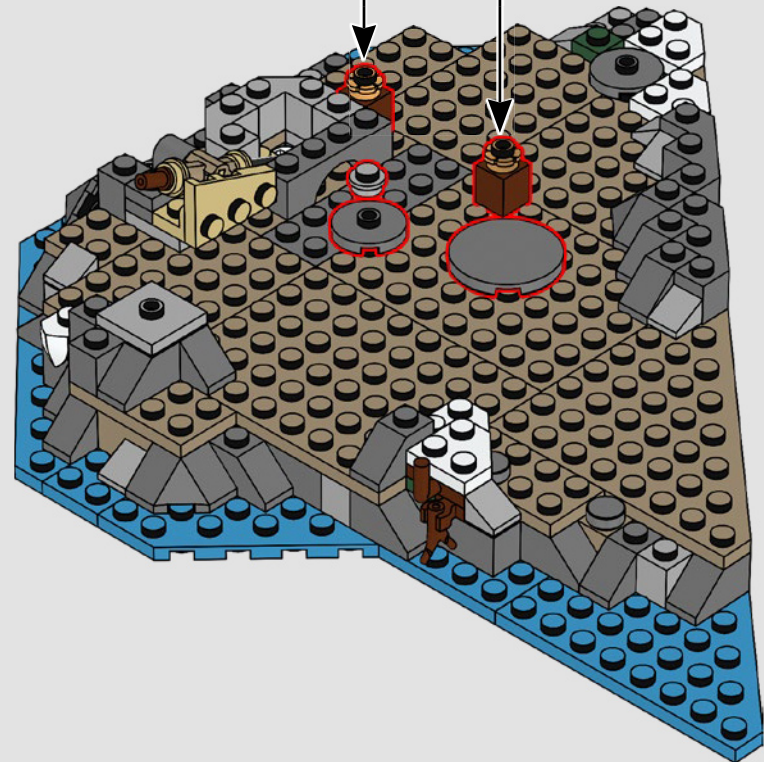
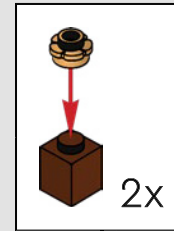

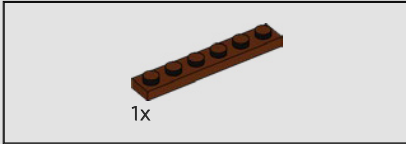
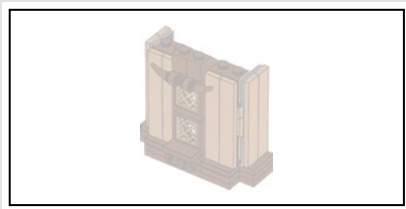

46

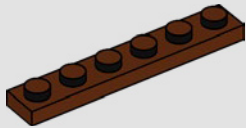

47

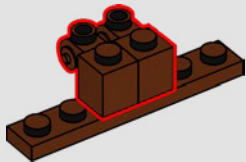

48

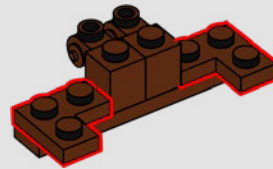

49

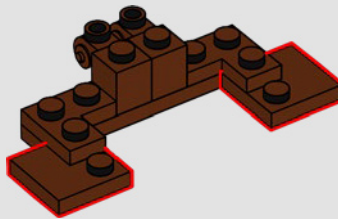

50

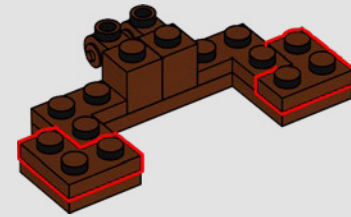

51

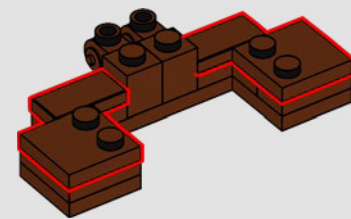



2x

52

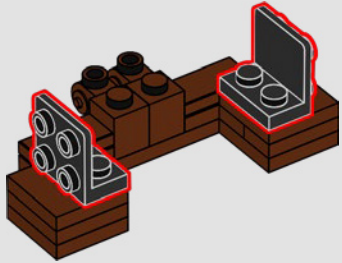

2x

53

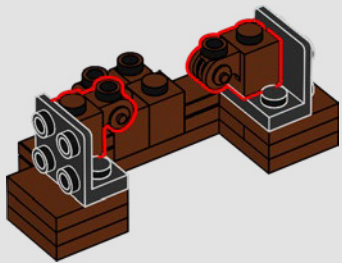

2x

54

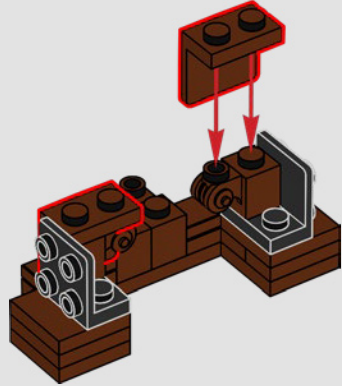

2x

55

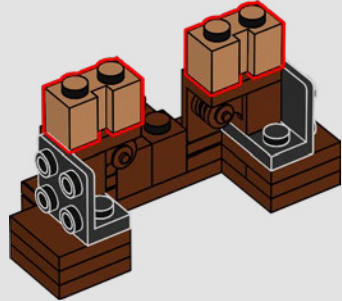

2x

2x

56

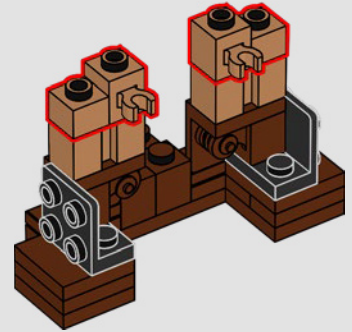

2x

57

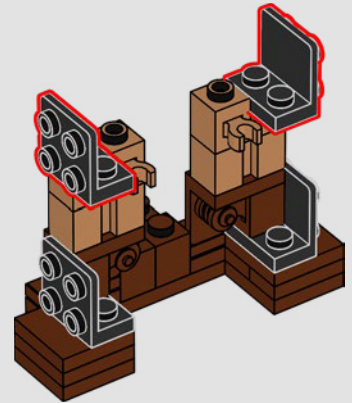

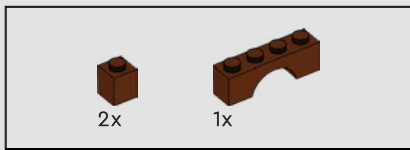

58

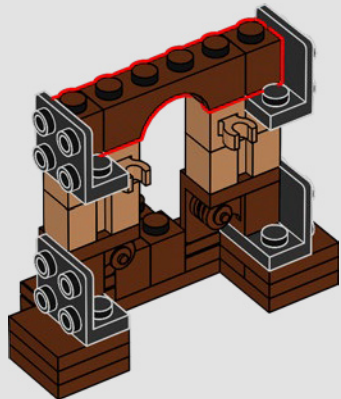

59

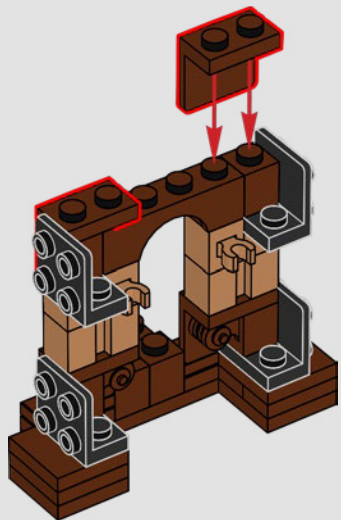

60

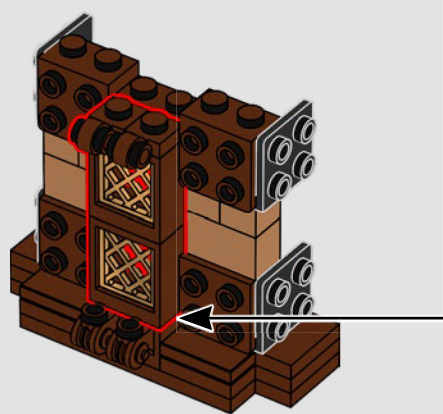
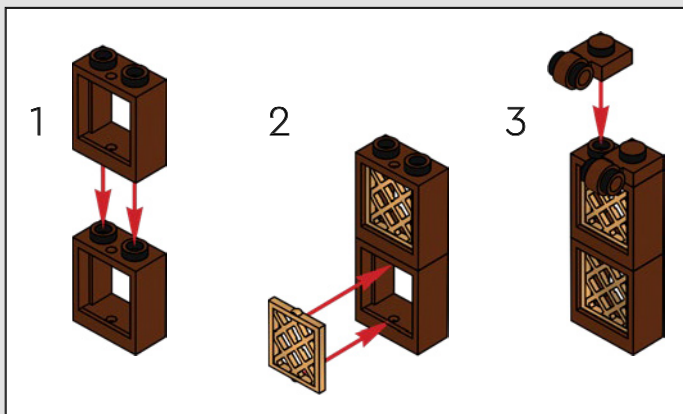

61

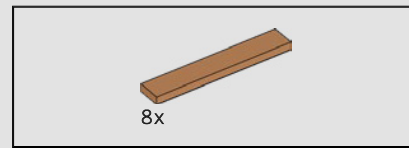
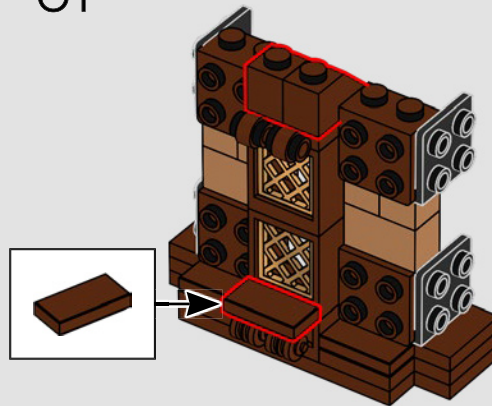

62

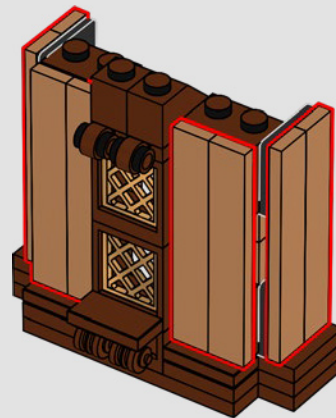



63

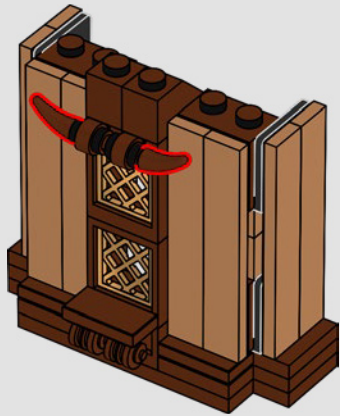

64

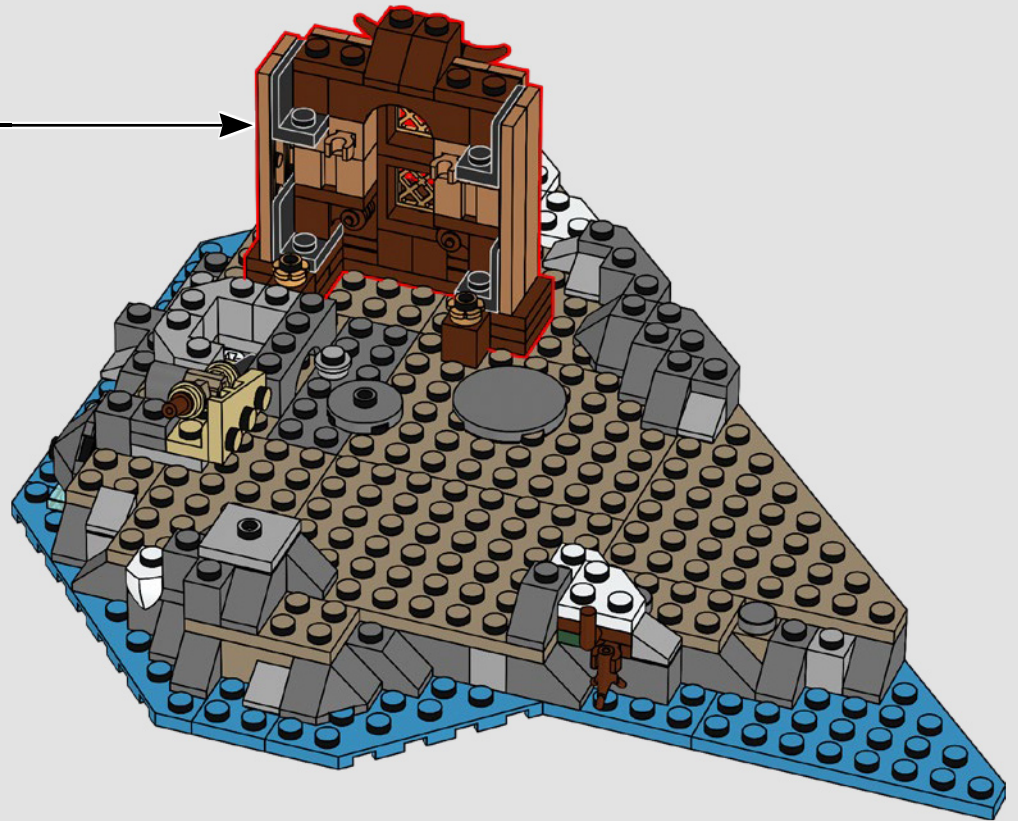



65

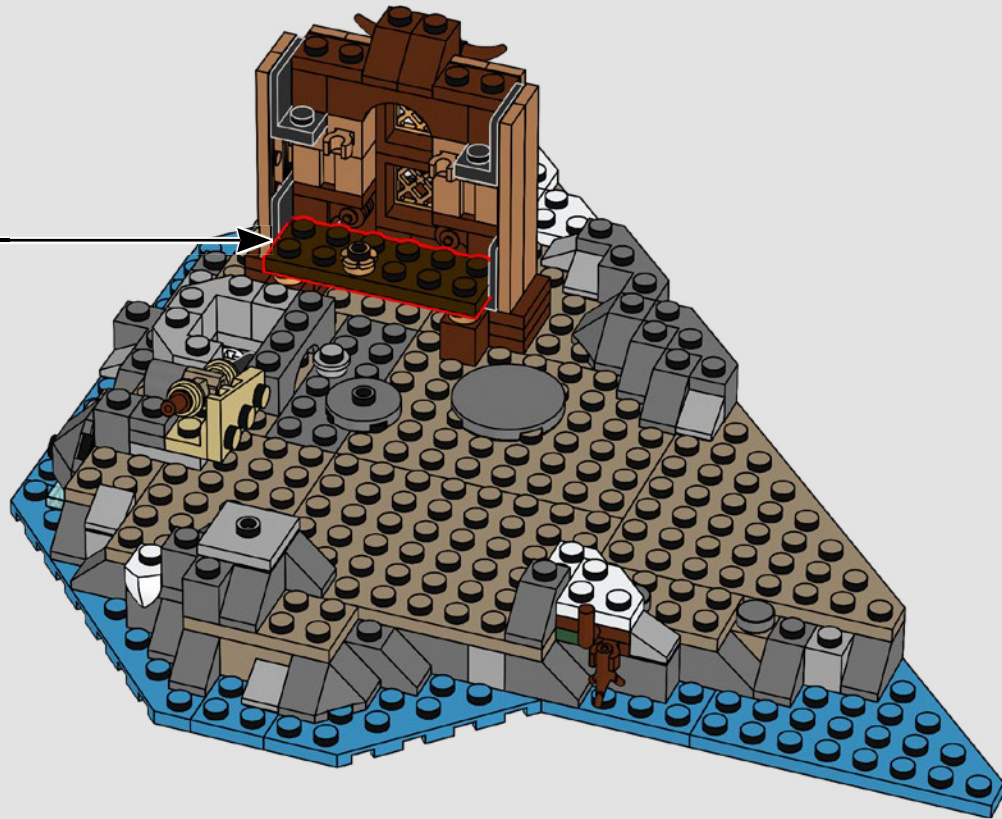
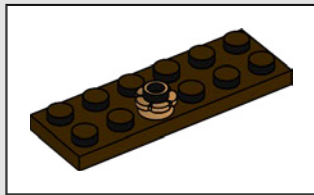



66

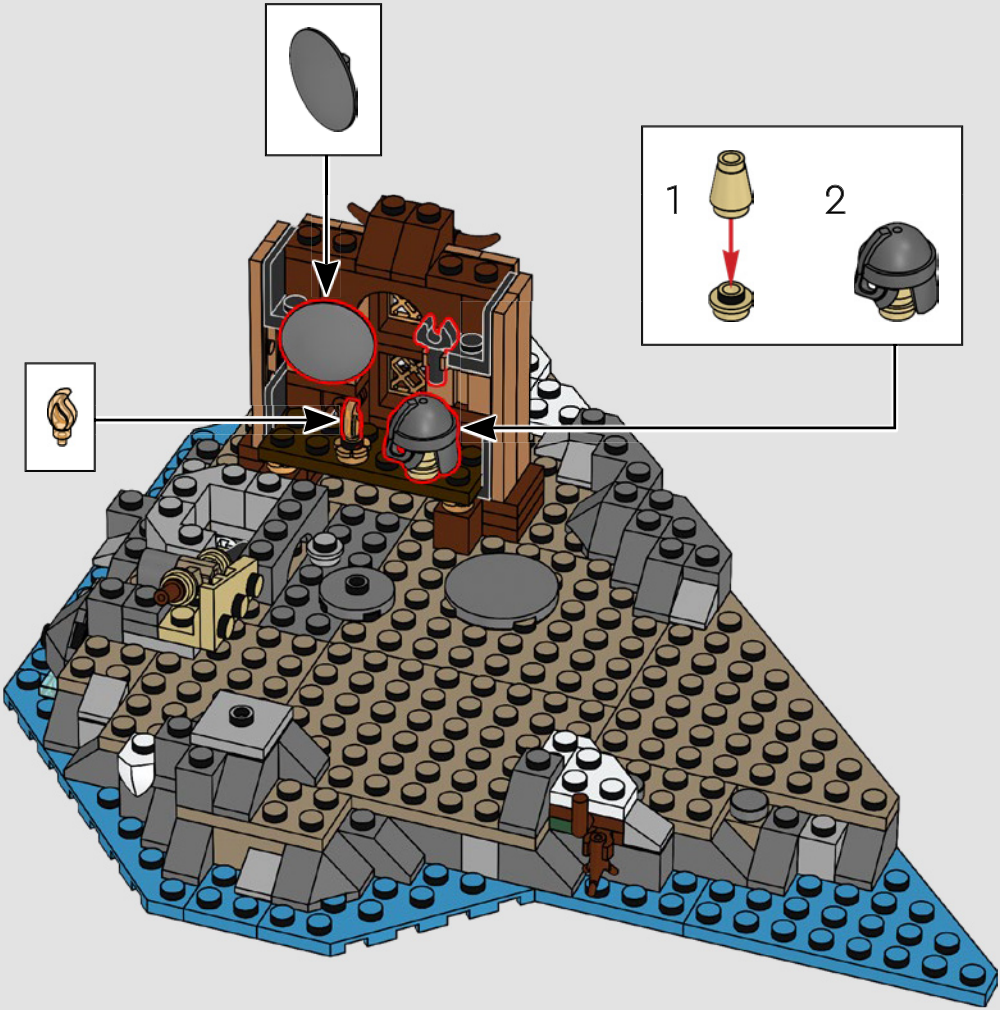

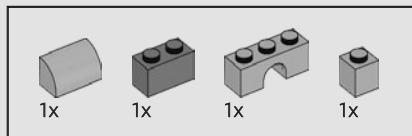

67

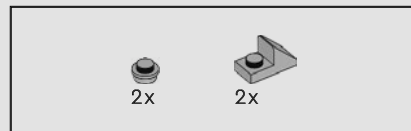
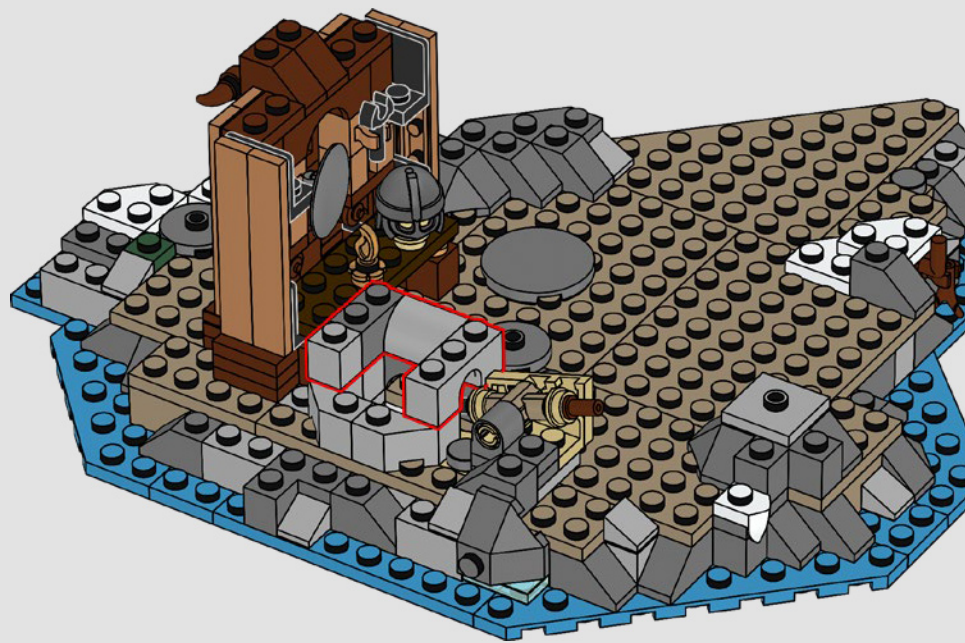

68

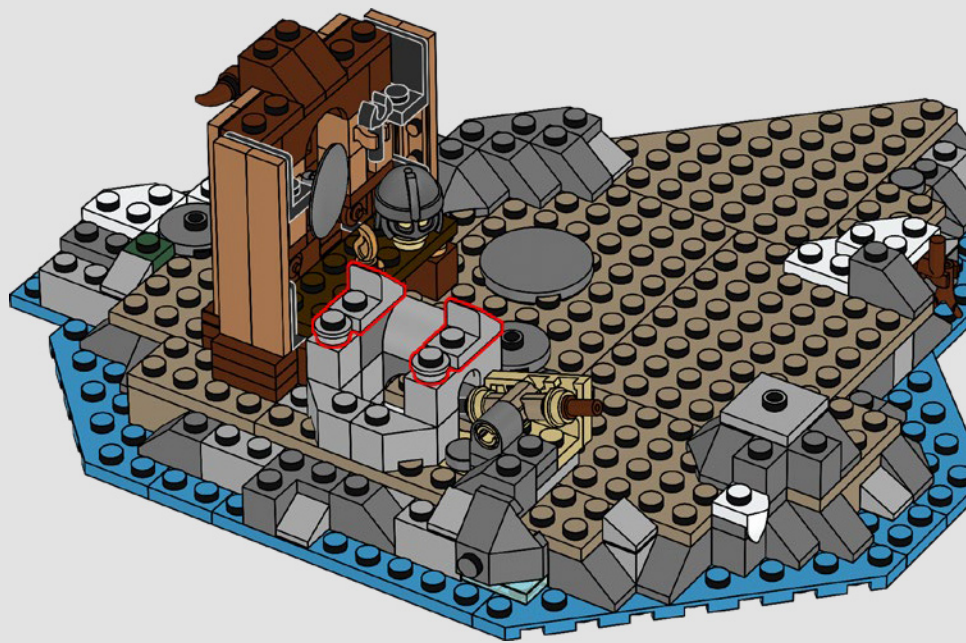

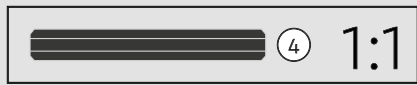
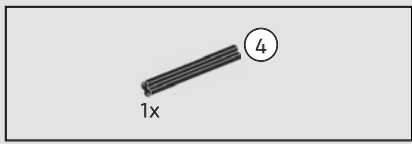

69

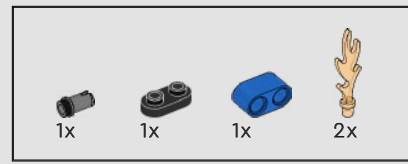
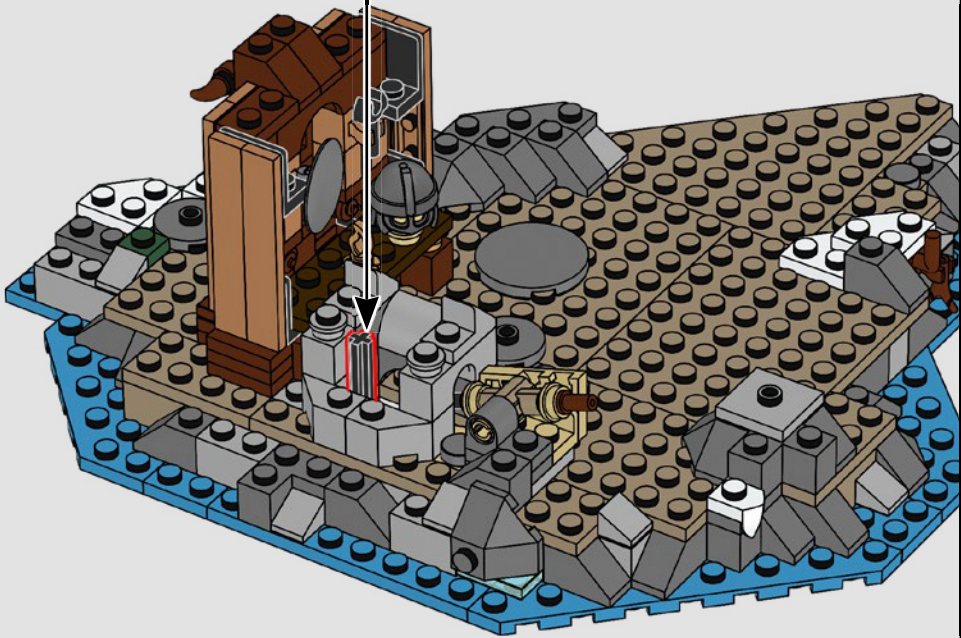

70

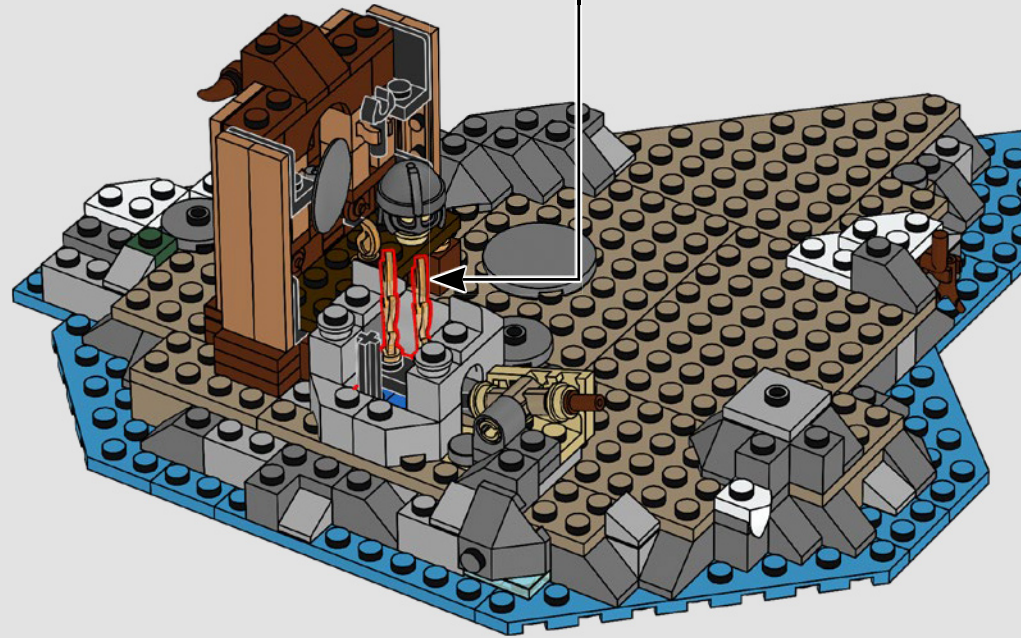
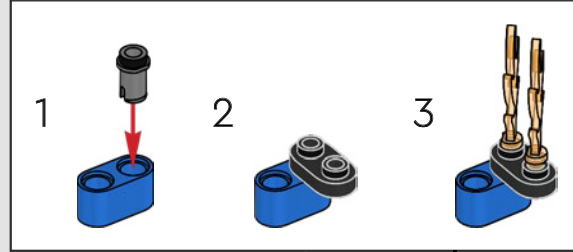

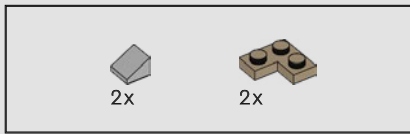

71

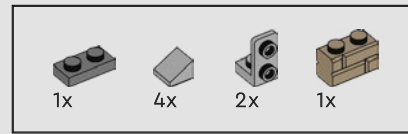
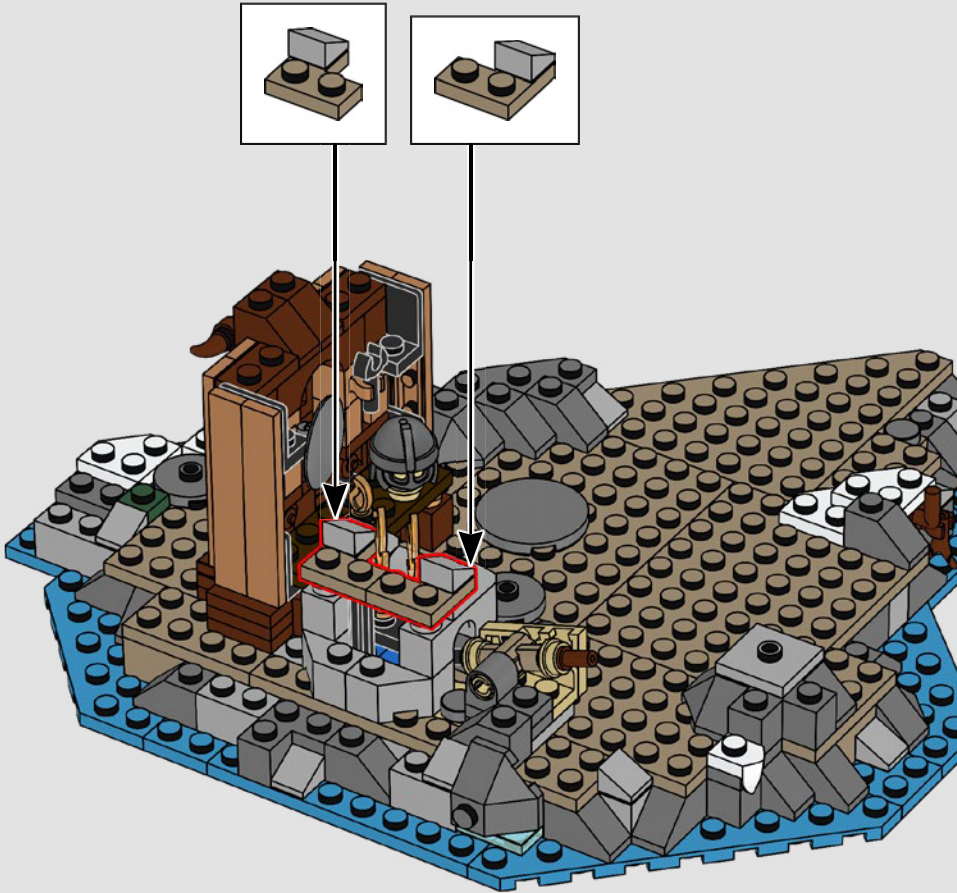

72

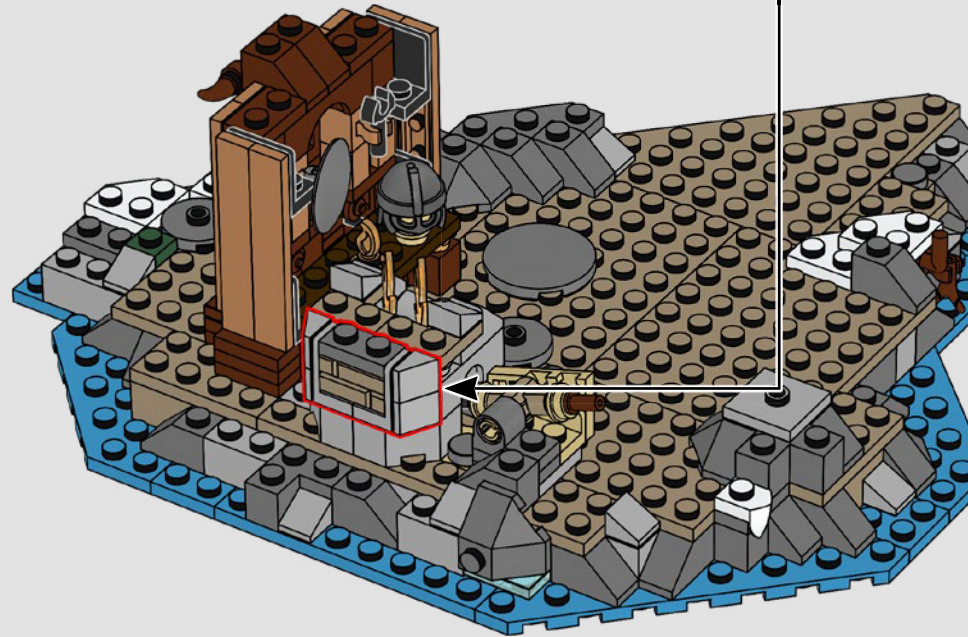
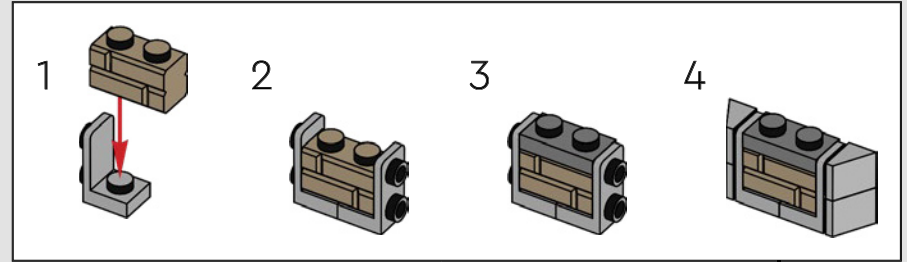

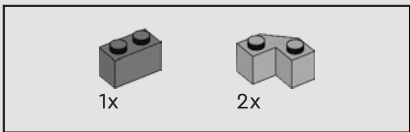

73

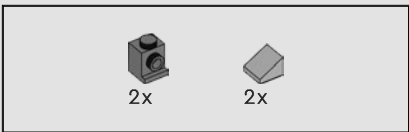
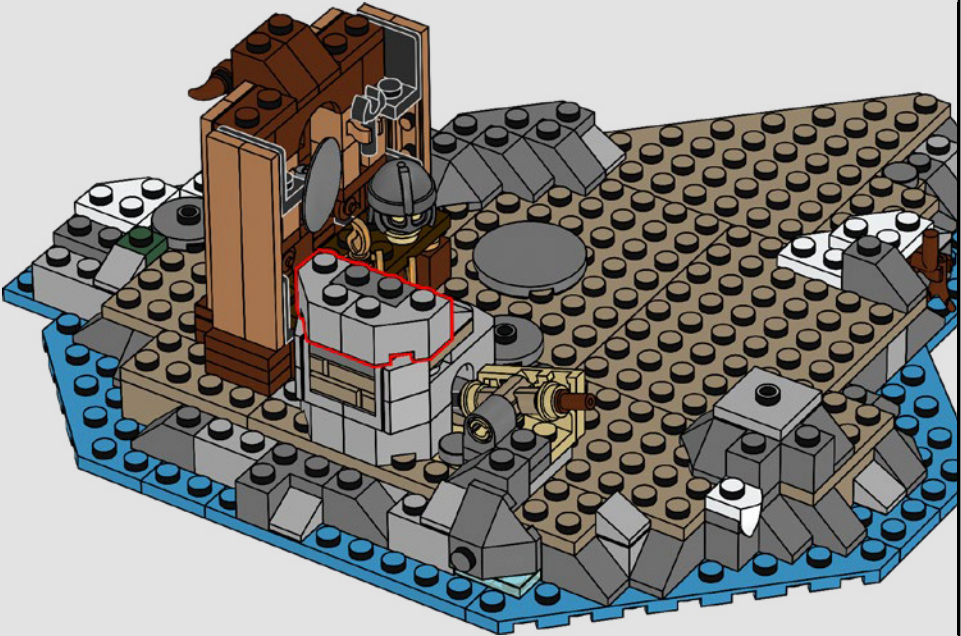

74

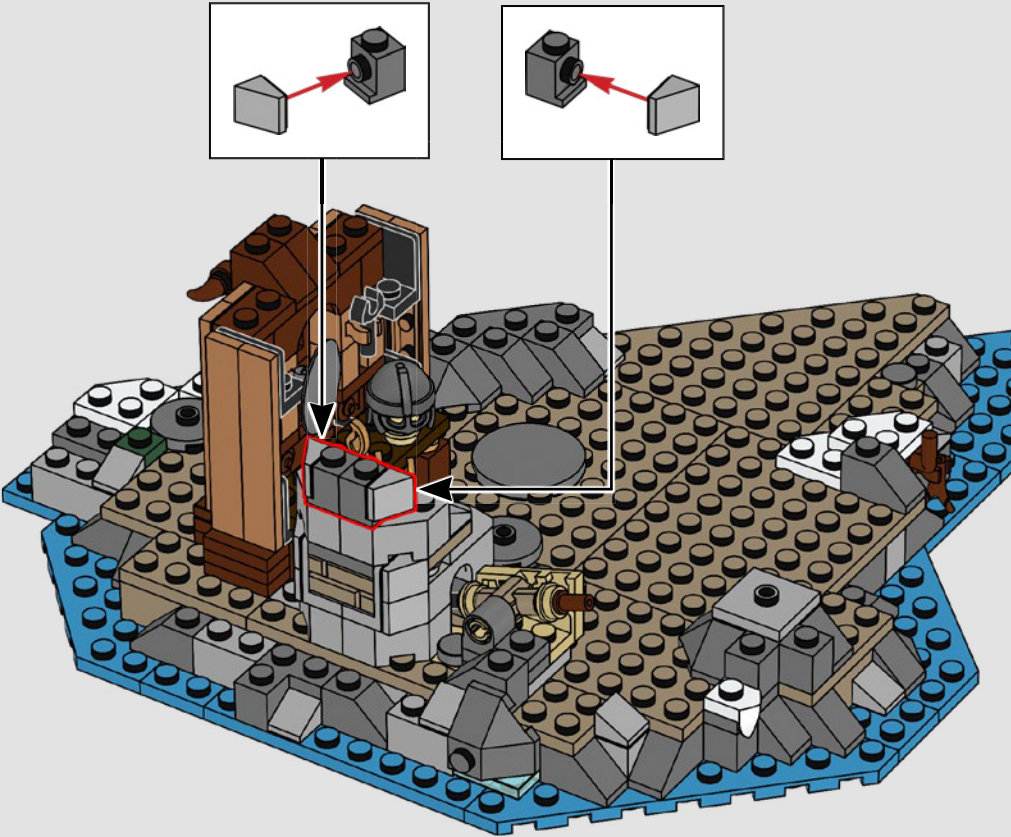

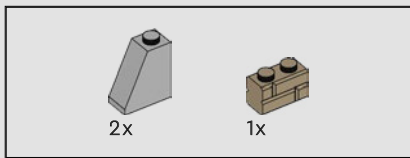

75

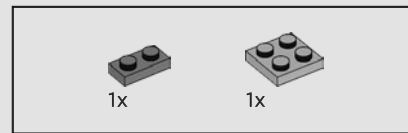
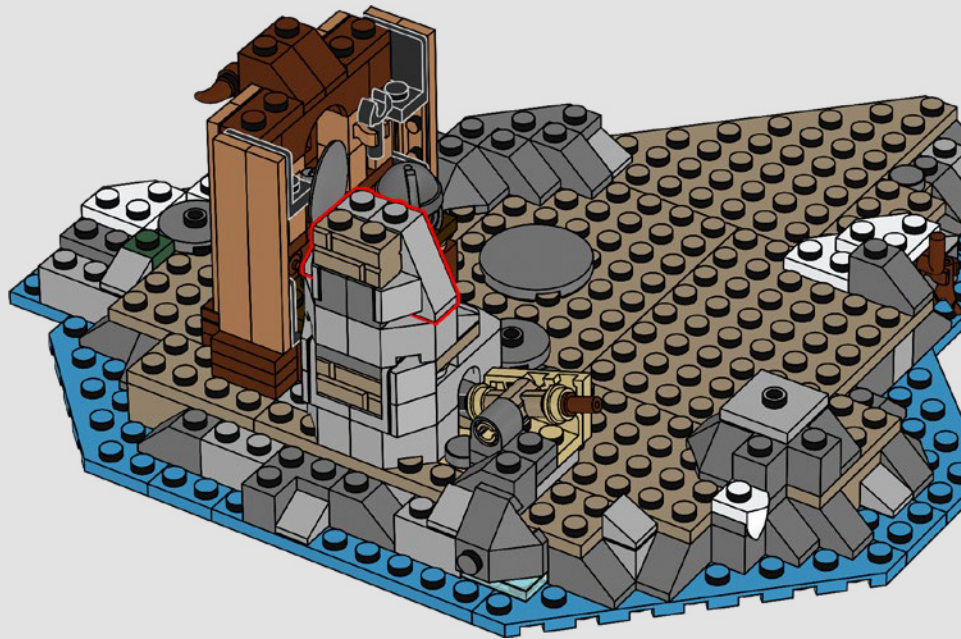

76

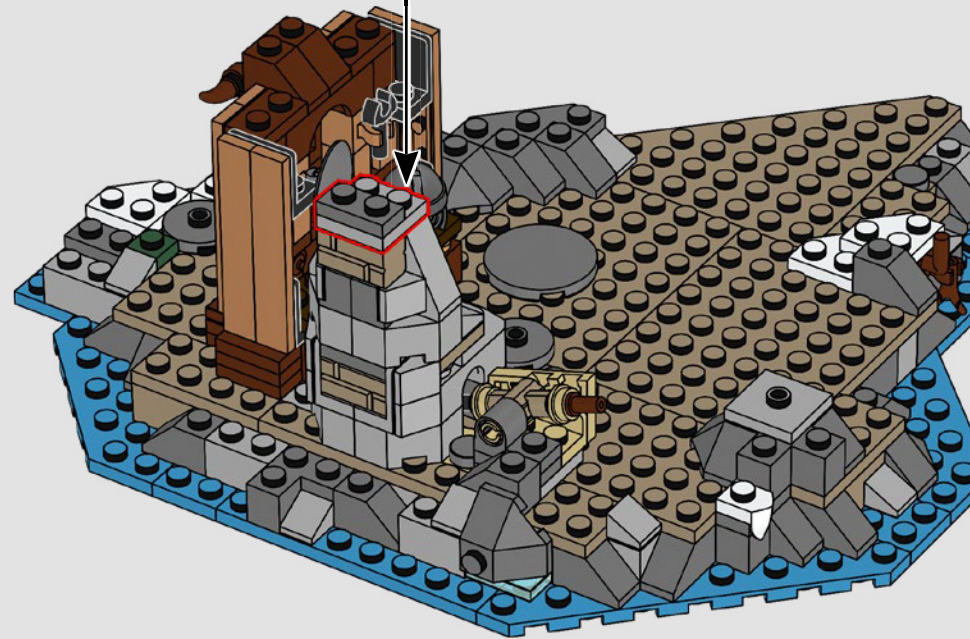
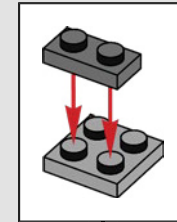

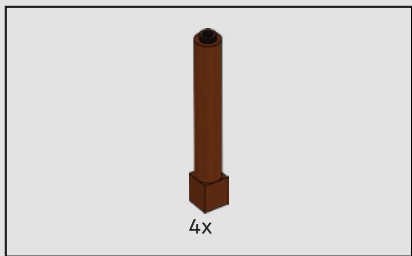

77

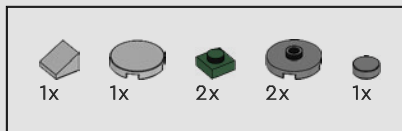
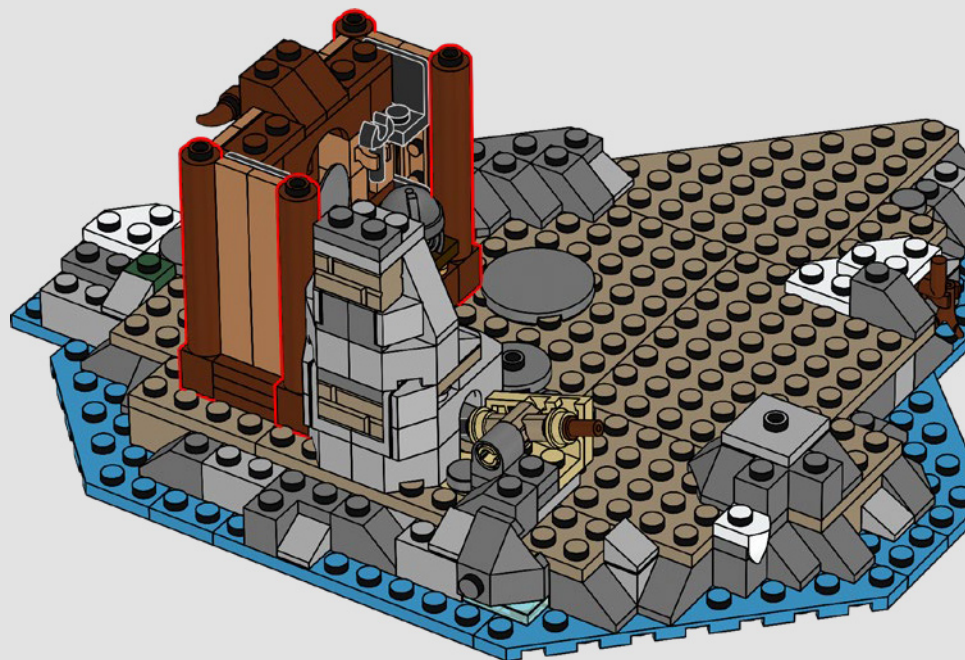

78

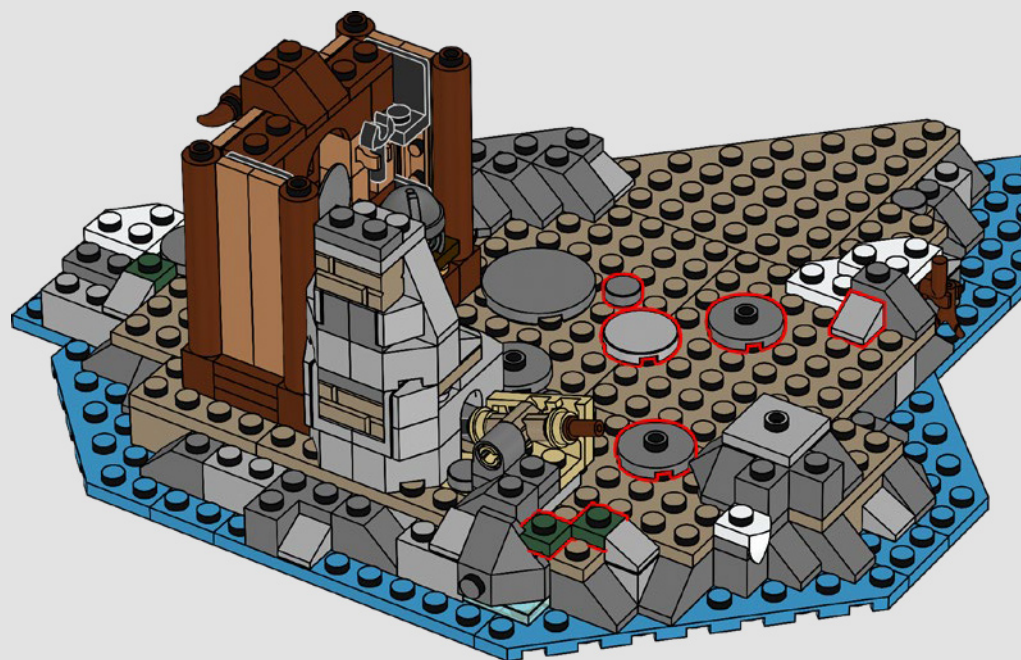

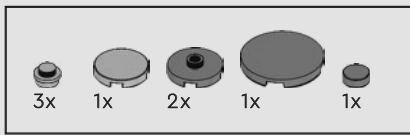

79

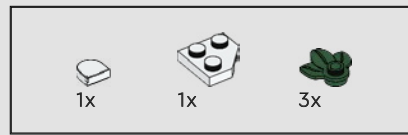
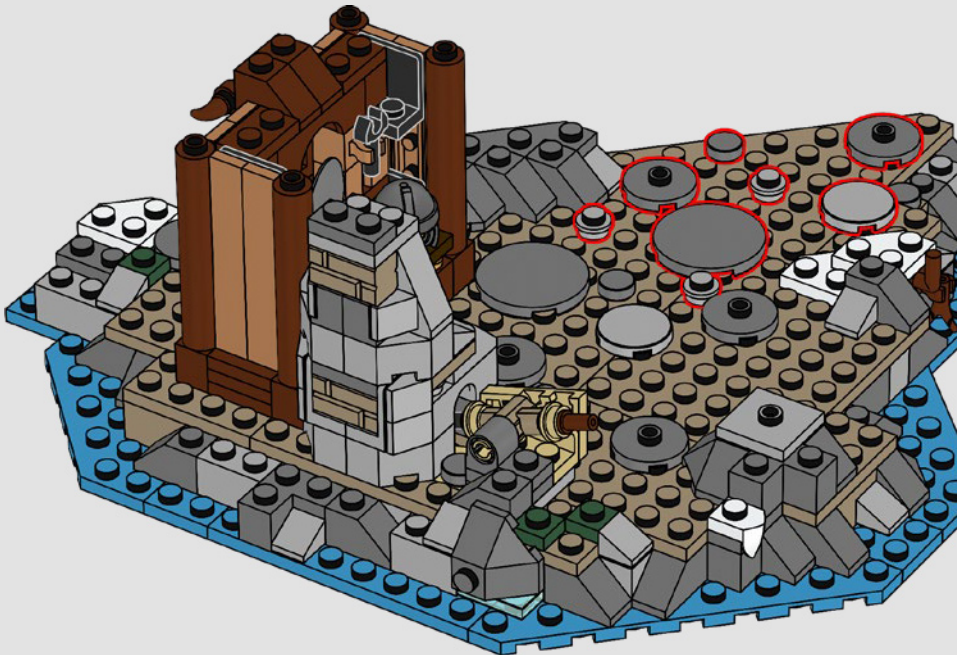

80

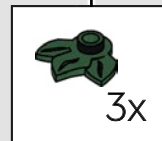
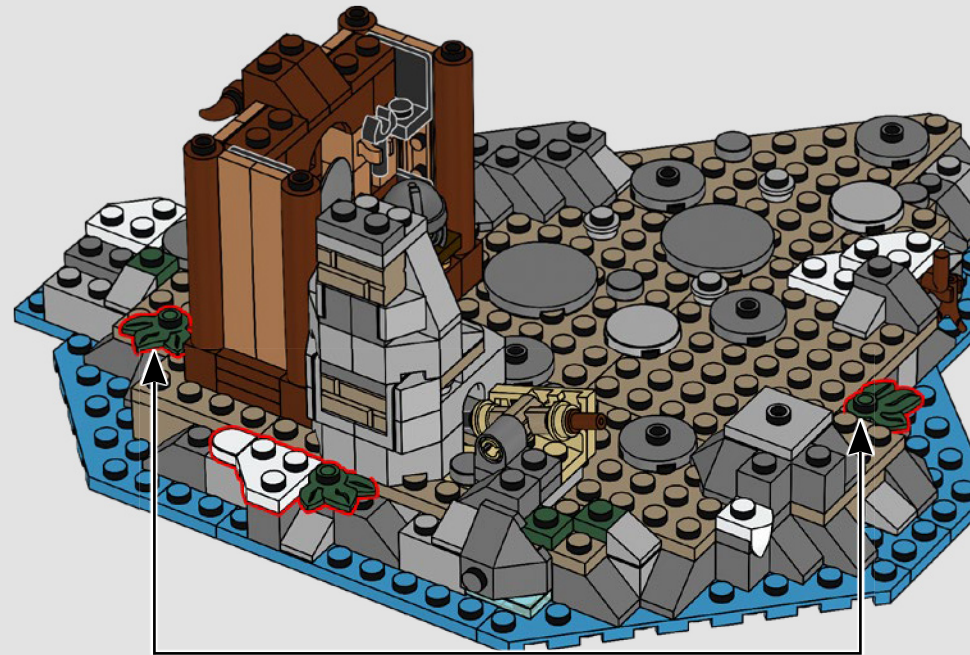

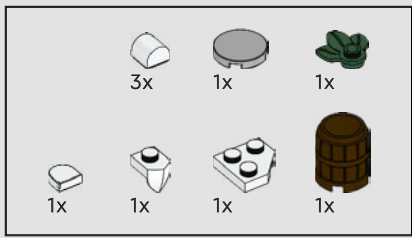

81

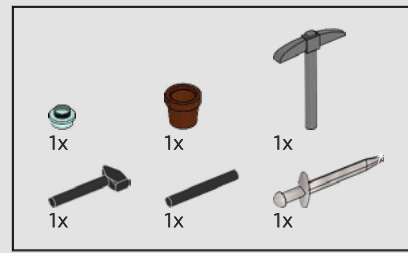

82

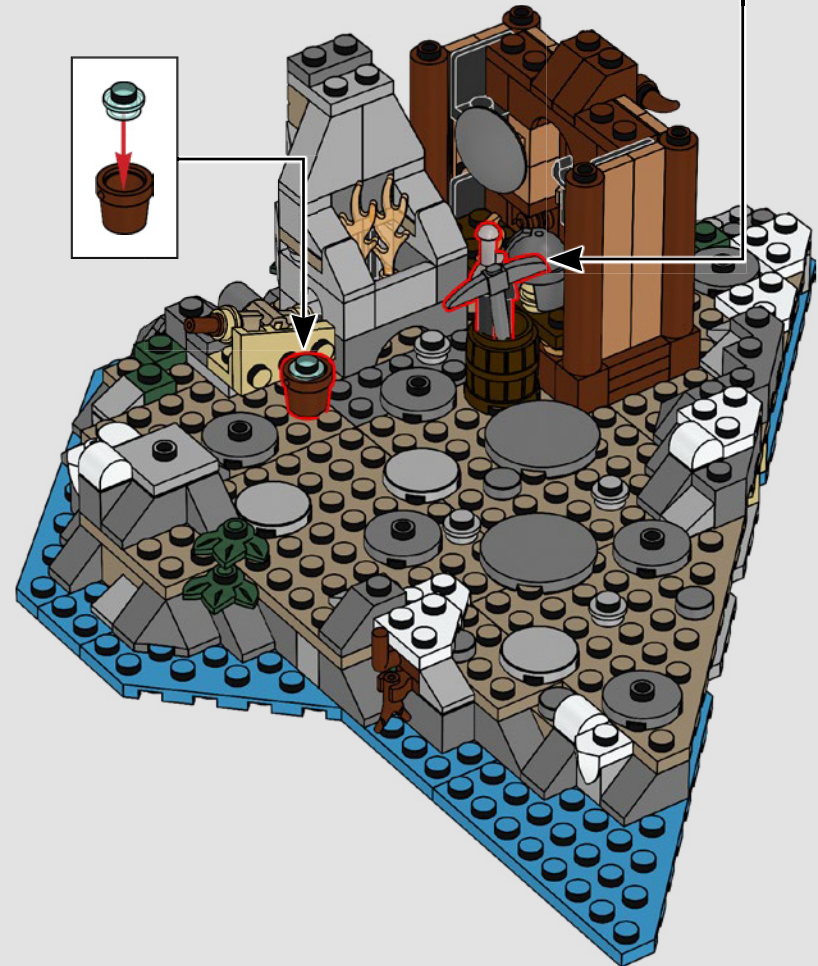
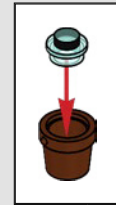
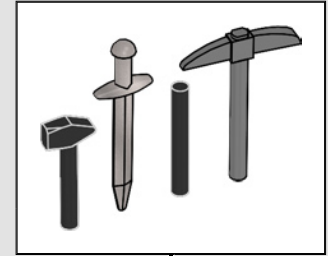

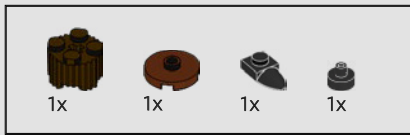

83

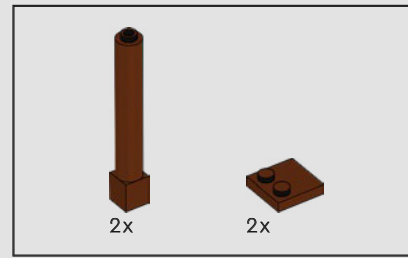
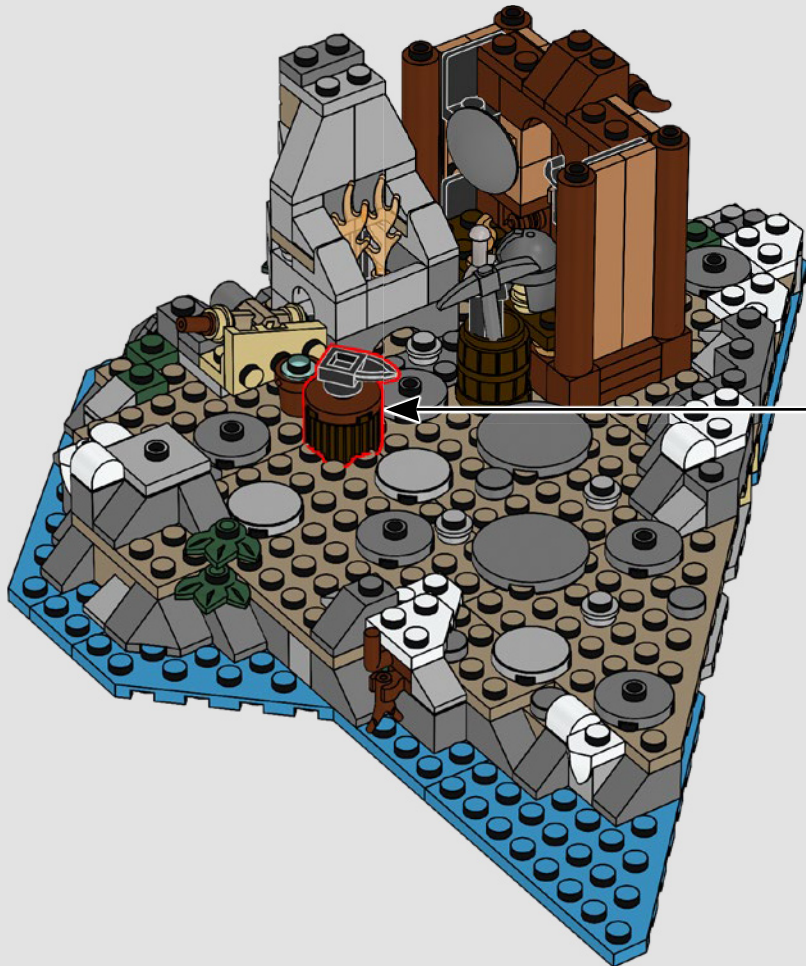
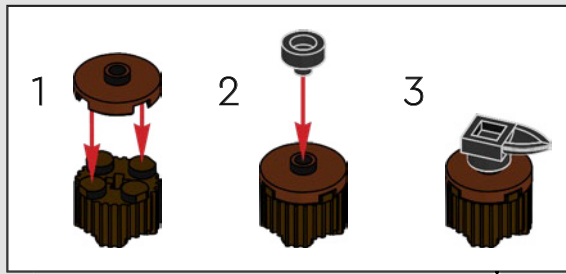

84

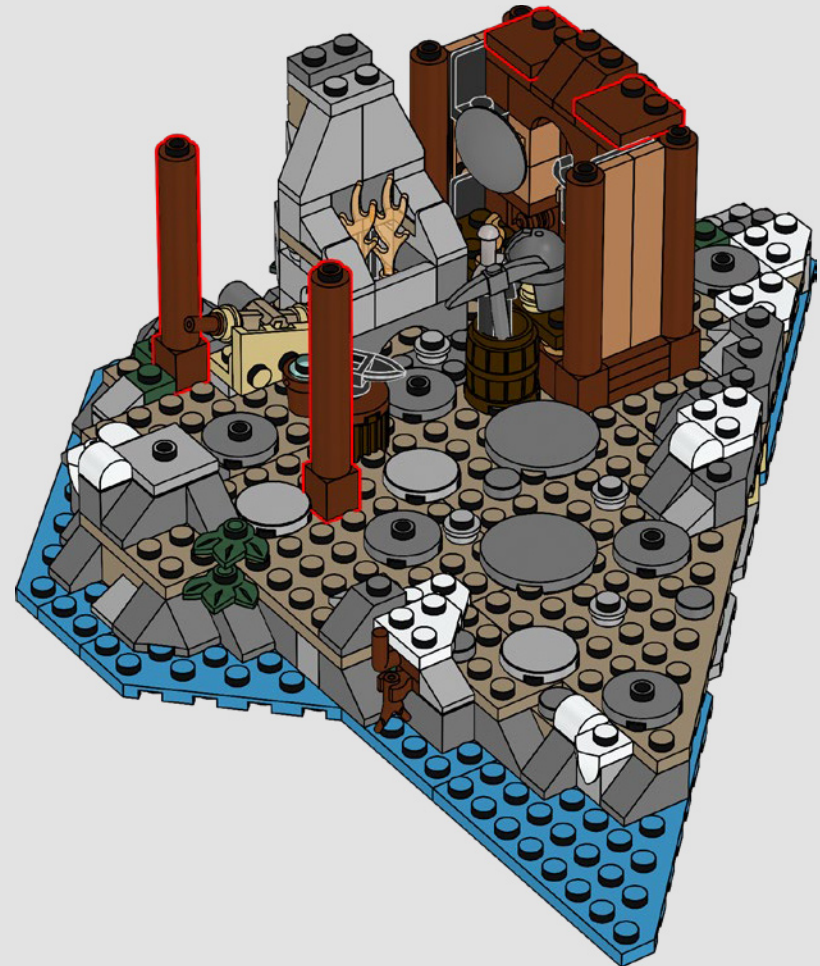

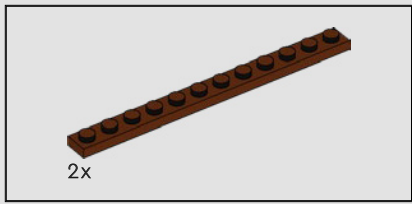

85

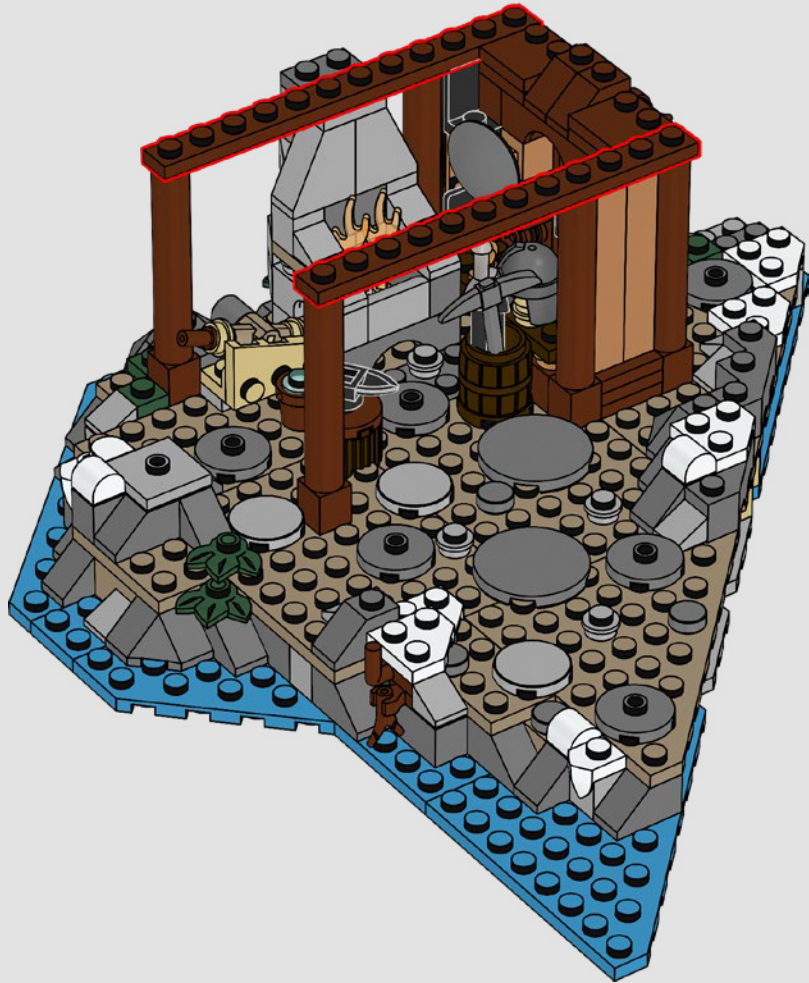

86

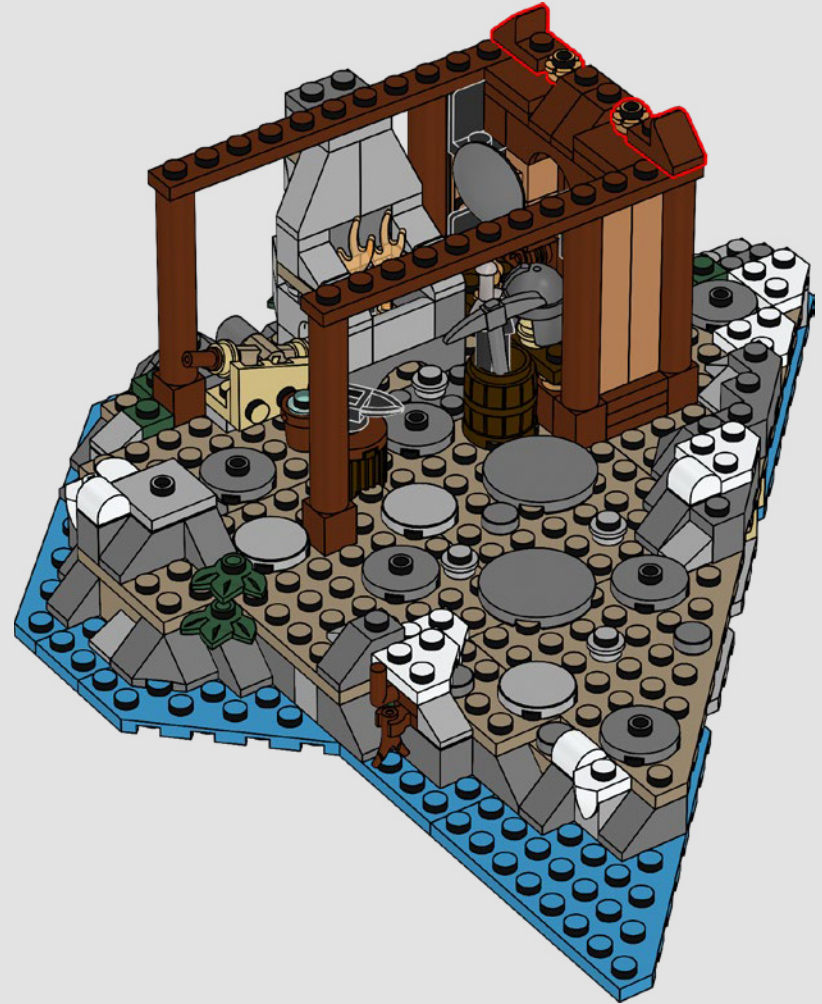

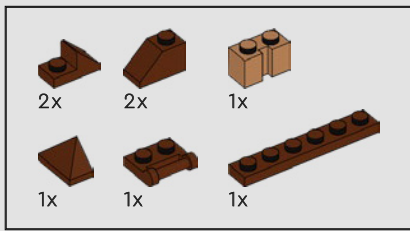

87

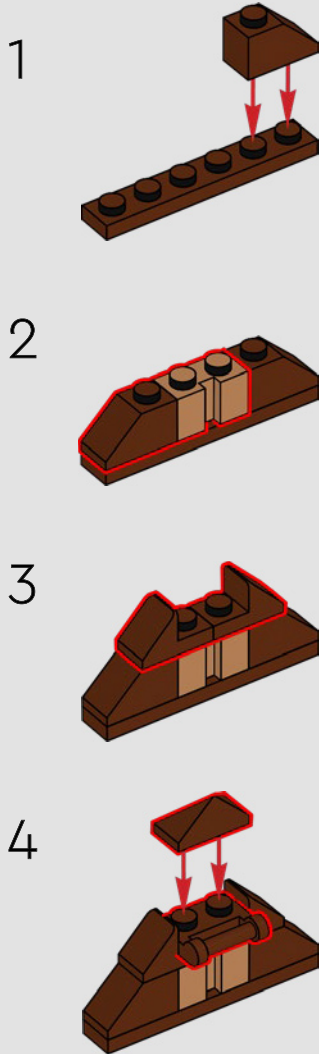

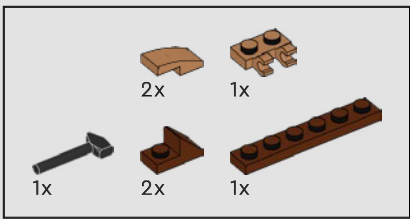

88

1

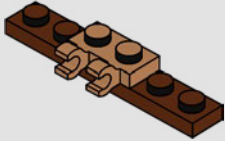

2

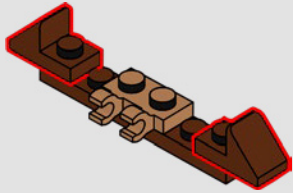

3

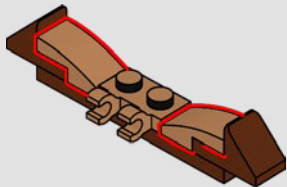

4

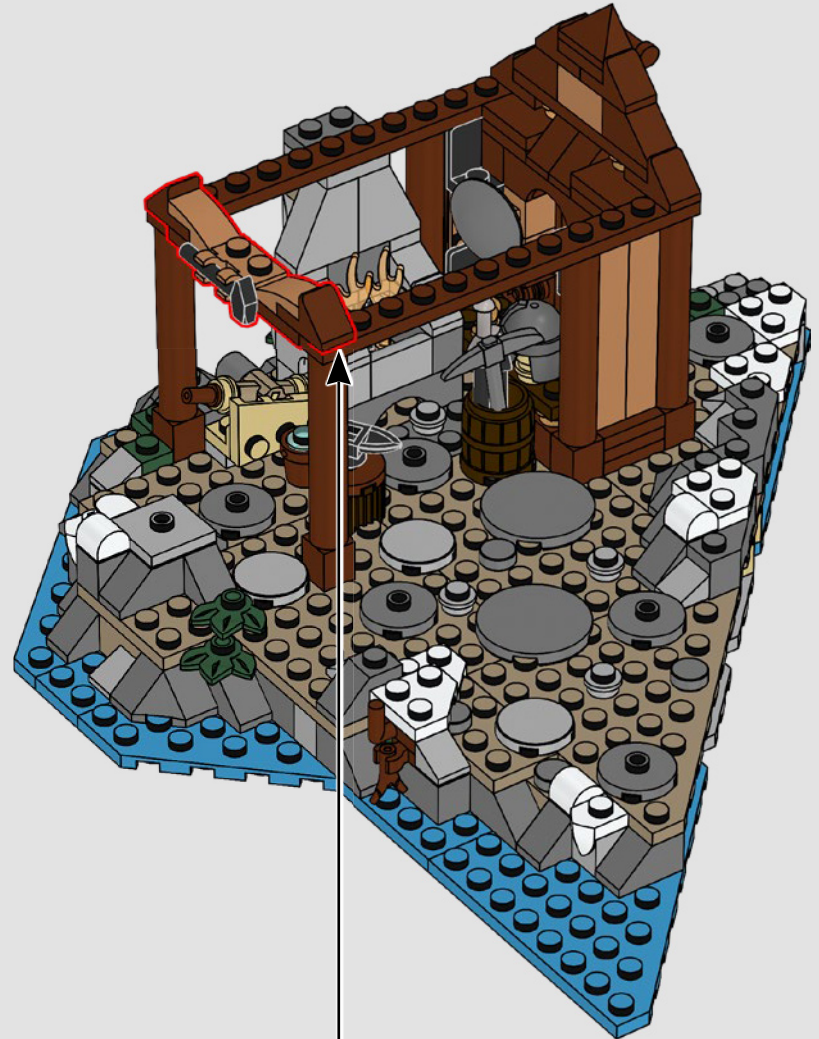
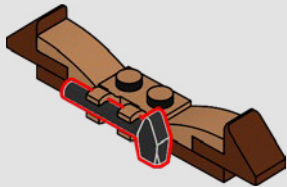

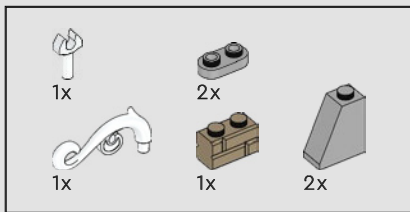

89

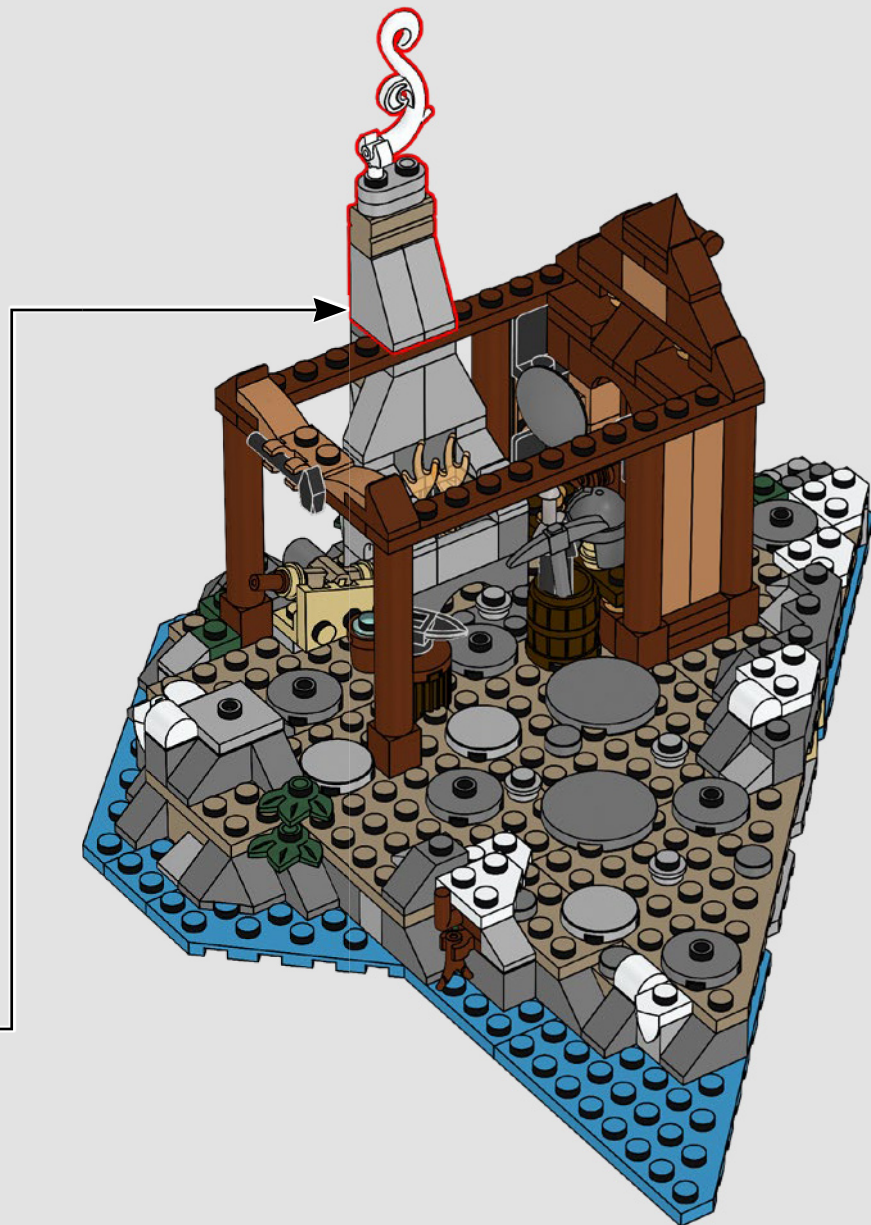
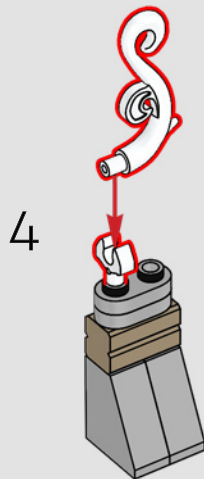
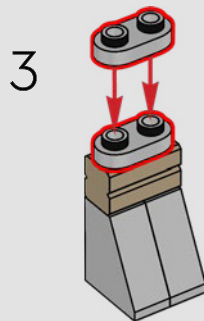
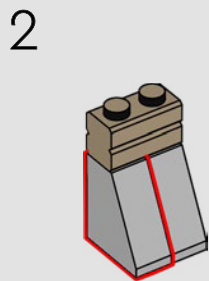
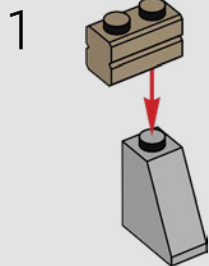

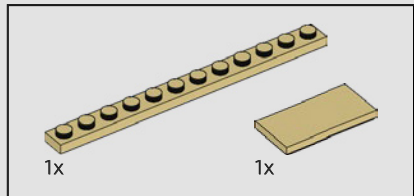
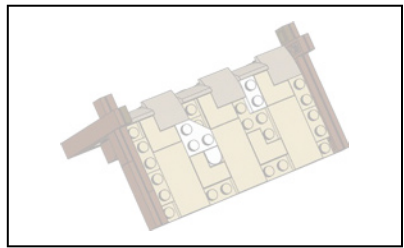

90

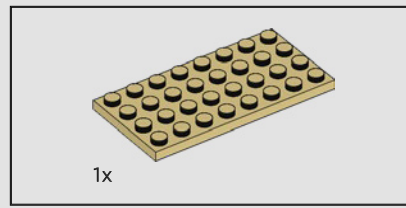
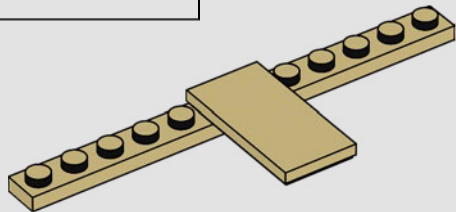

91

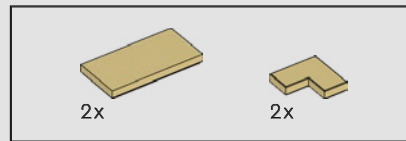
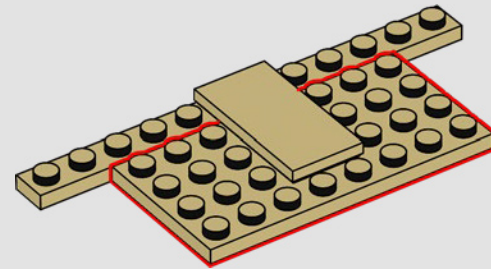

92

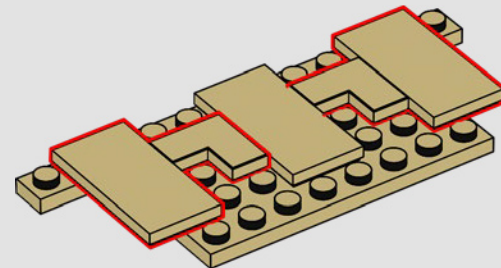

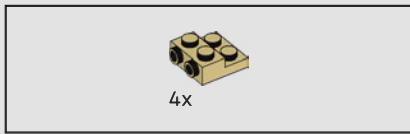

93

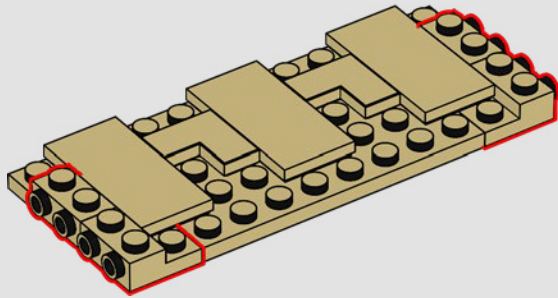

94

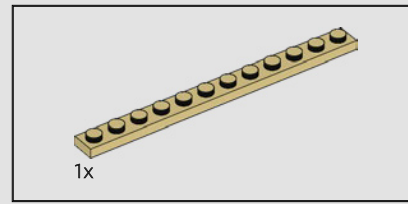
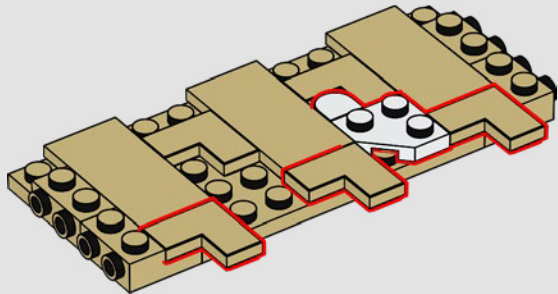

95

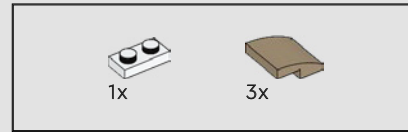
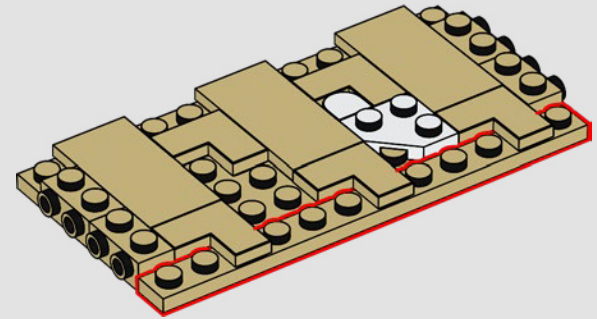

96

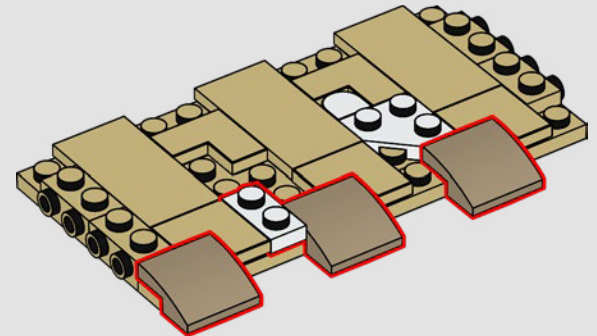

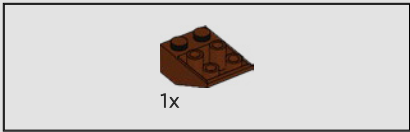

97

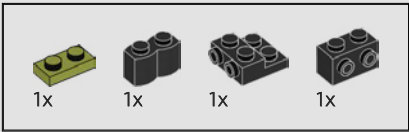
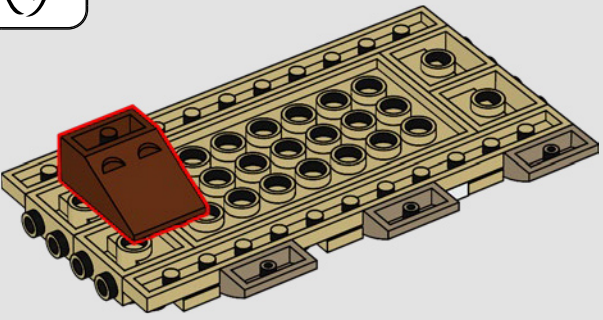

98

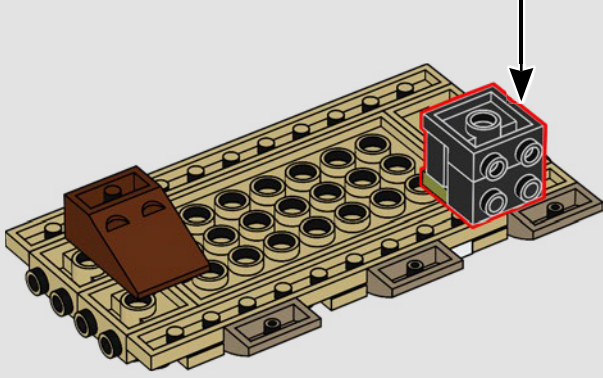
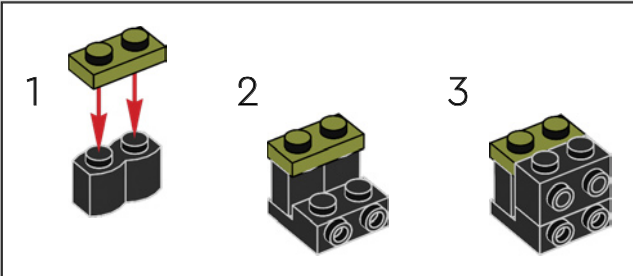

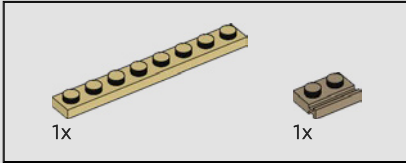
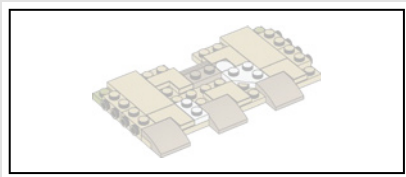

99

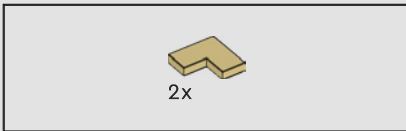
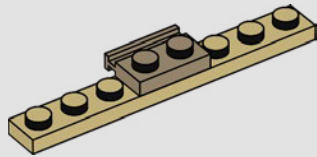

100

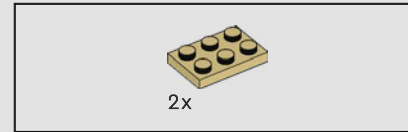
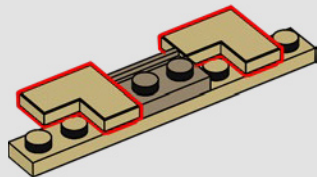

101

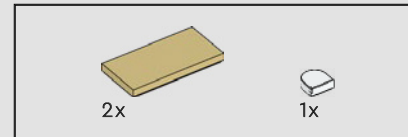
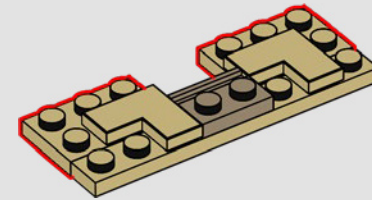

102

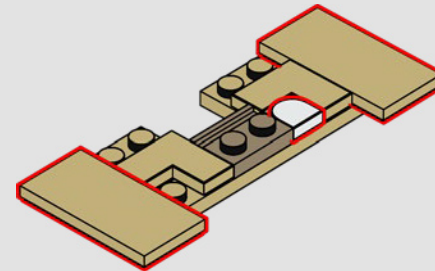

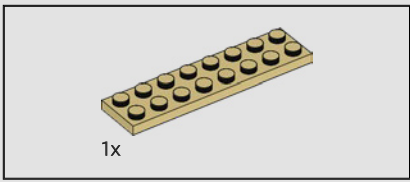

103

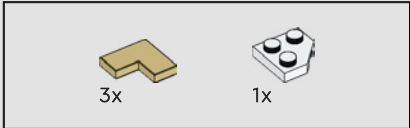
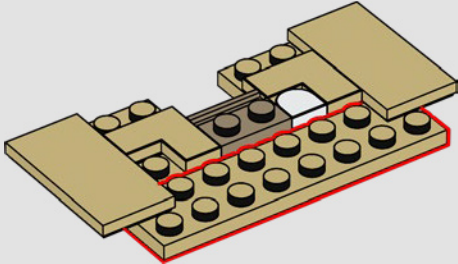

104

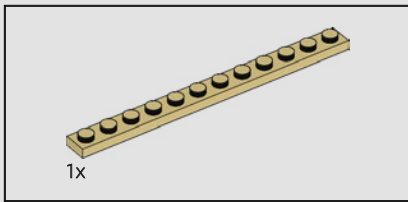
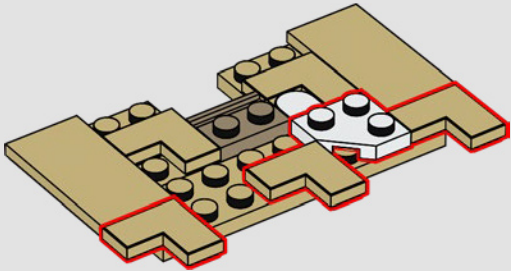

105

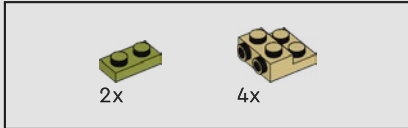
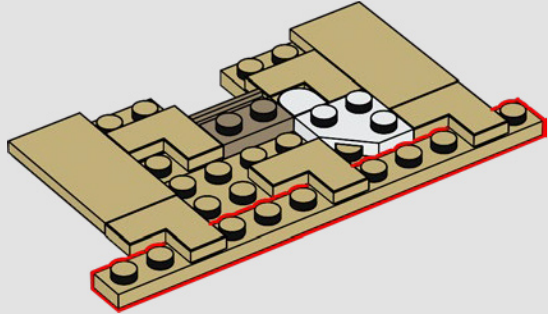

106

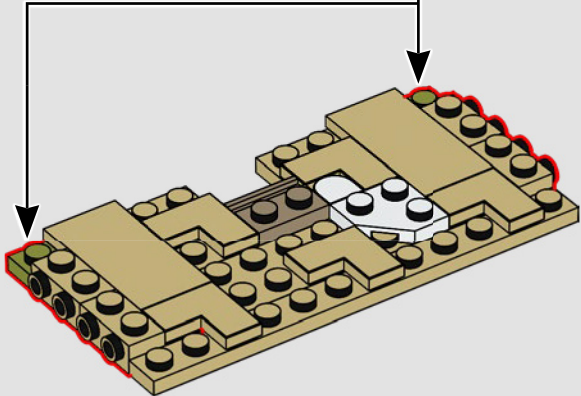
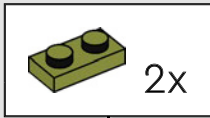

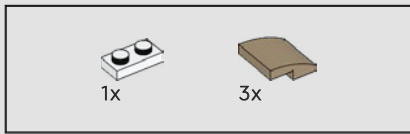

107

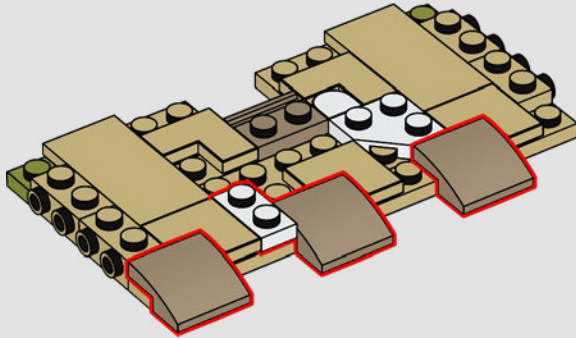

108

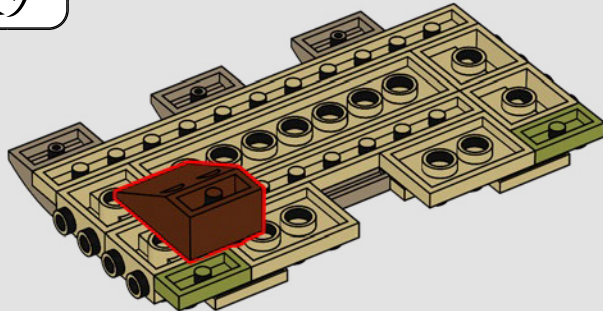

109

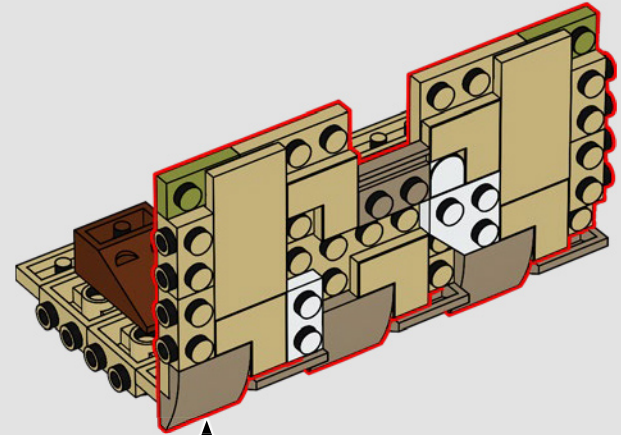

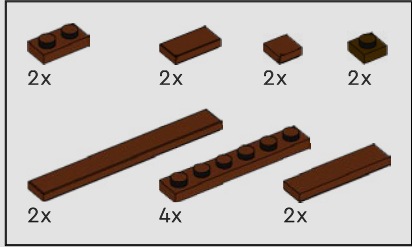
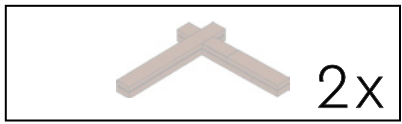

110

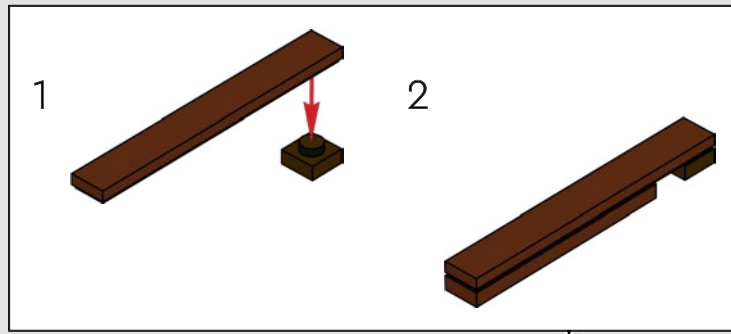
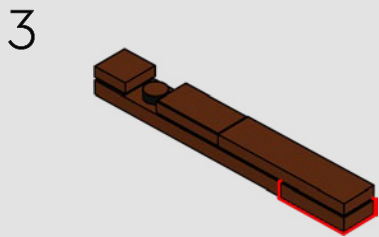
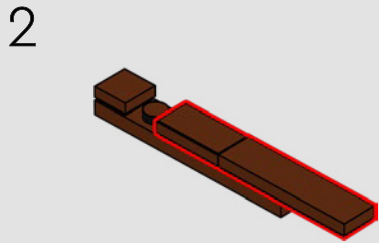
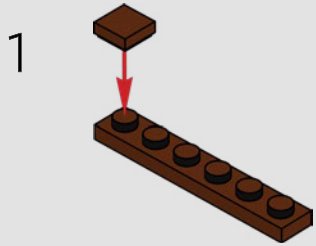

4

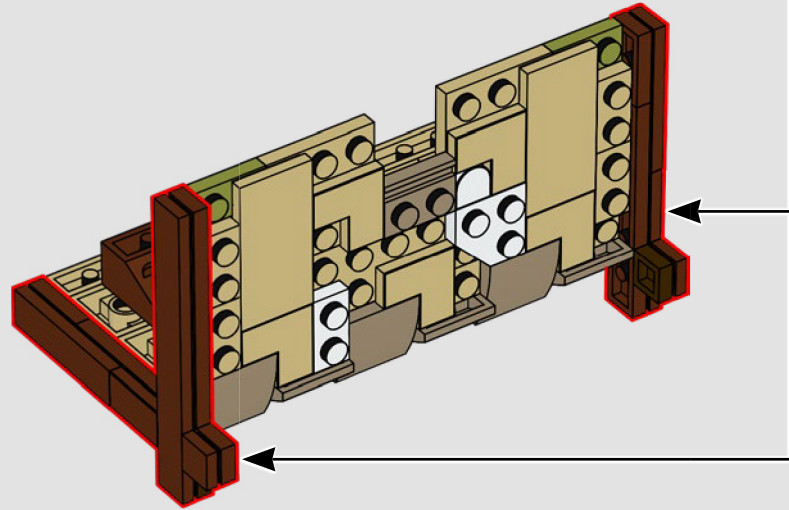
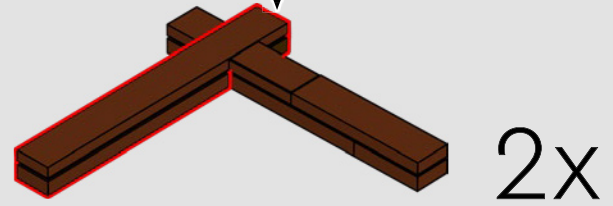

111

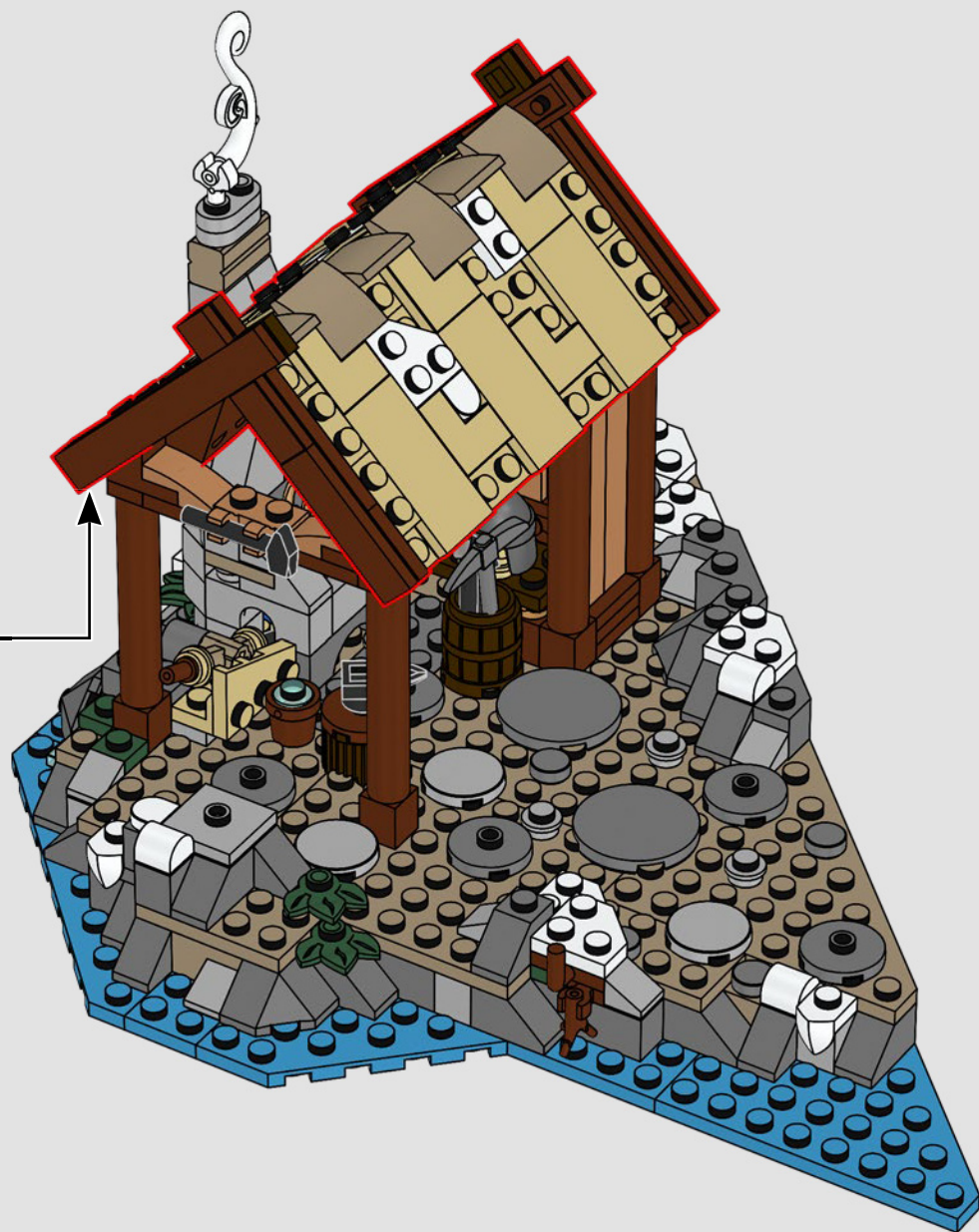



112

1



2

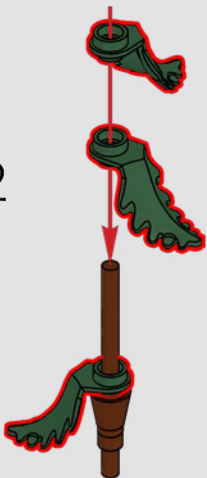

3

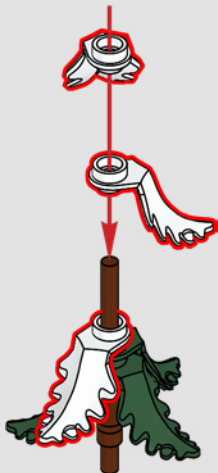

4

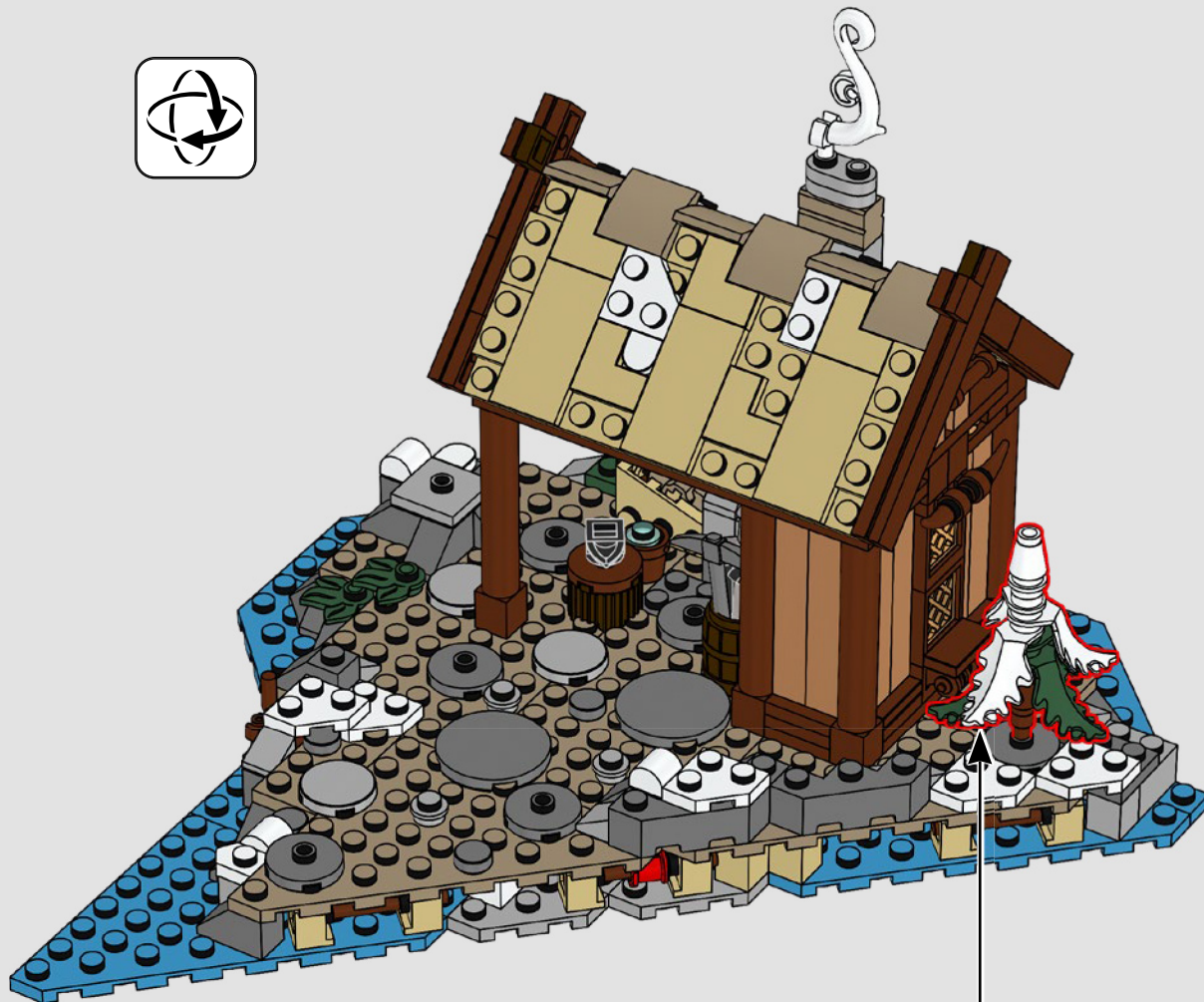
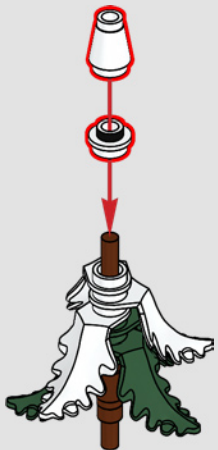

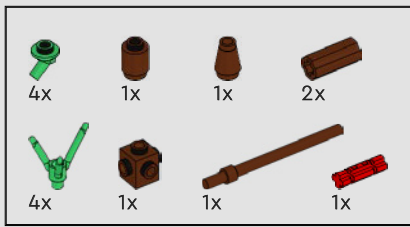

113

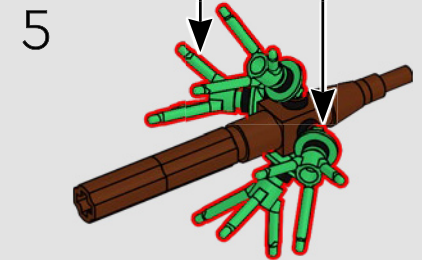
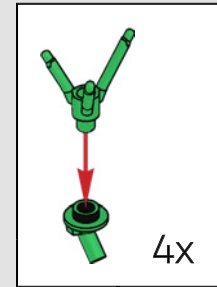
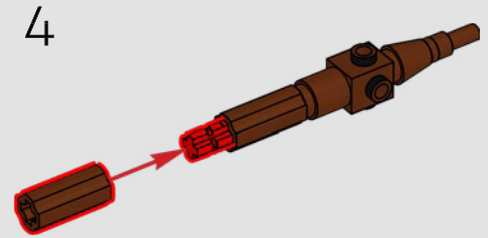
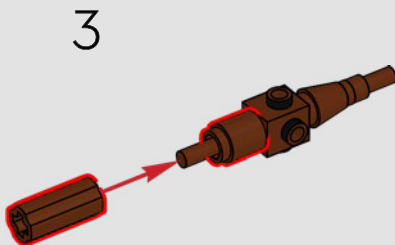
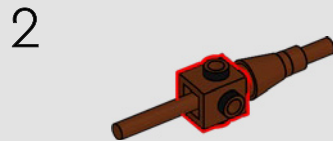
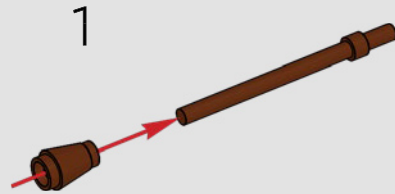



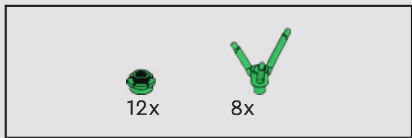

114

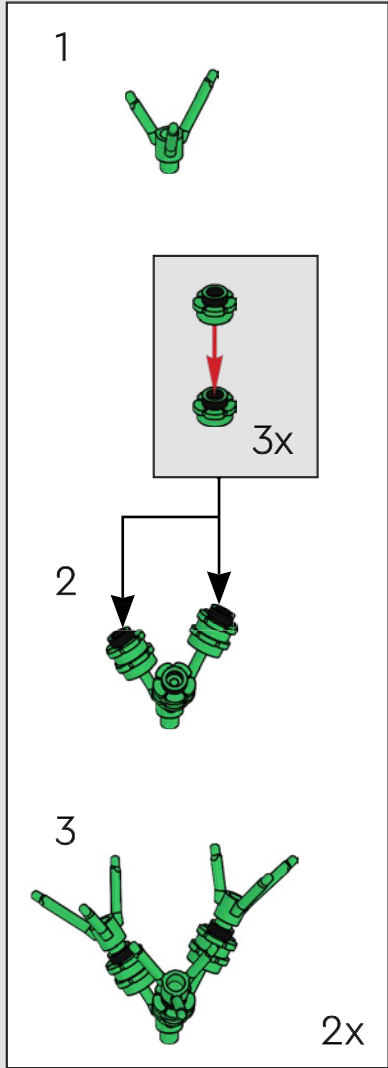

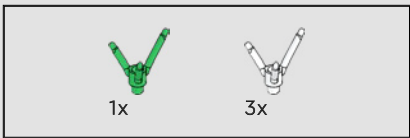

115

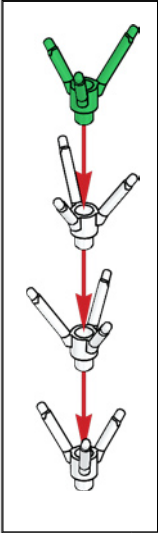

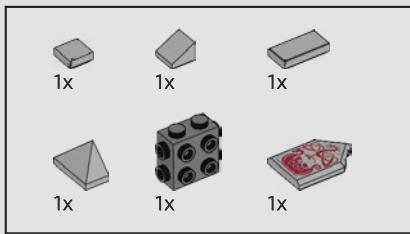

116

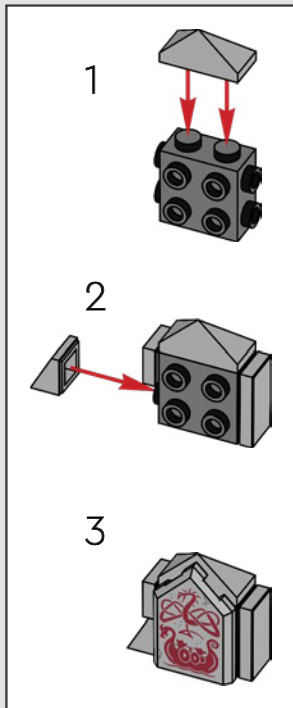

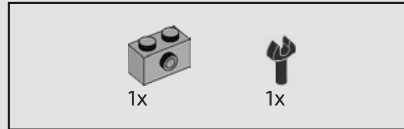
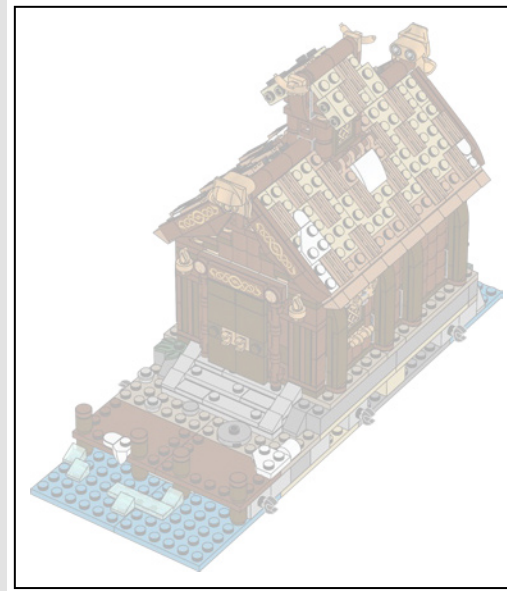
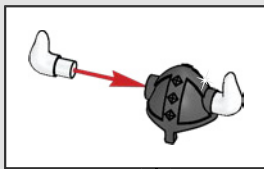
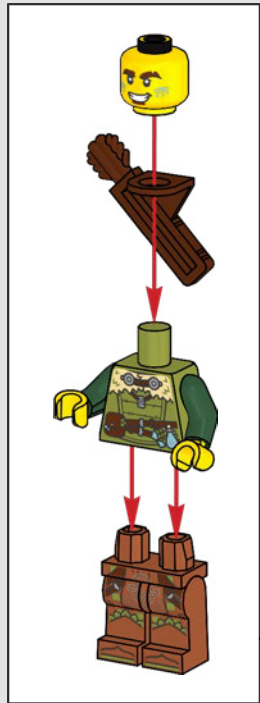

117

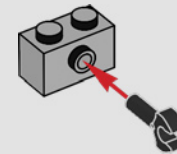

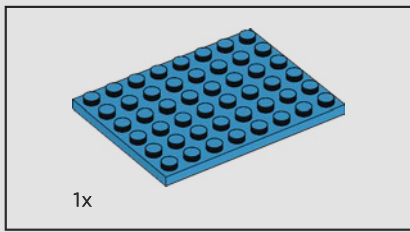

118

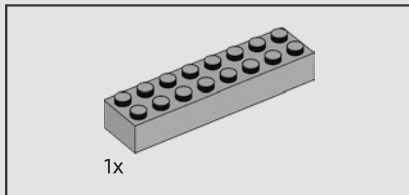
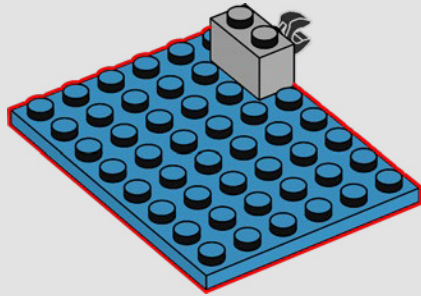

119

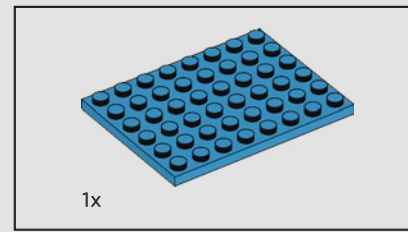
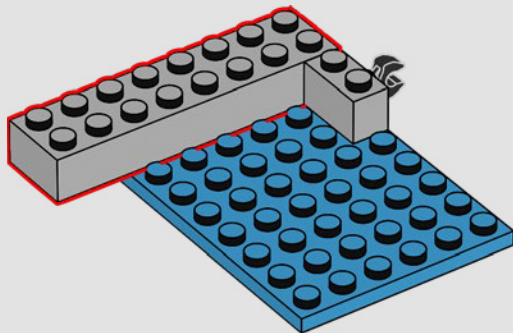

120

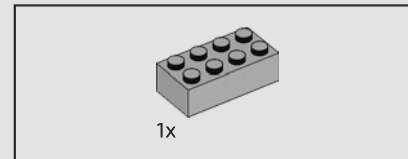
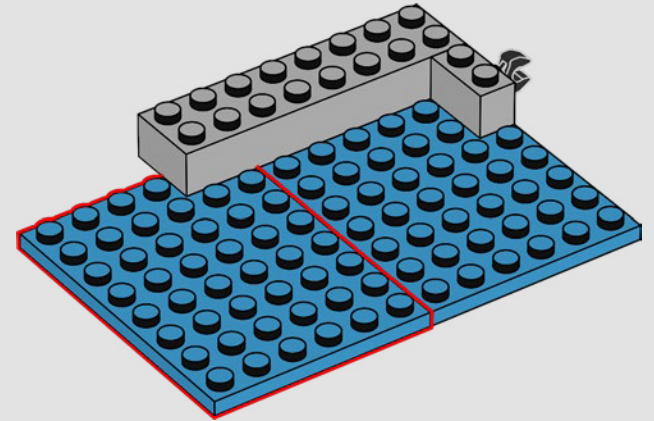

121

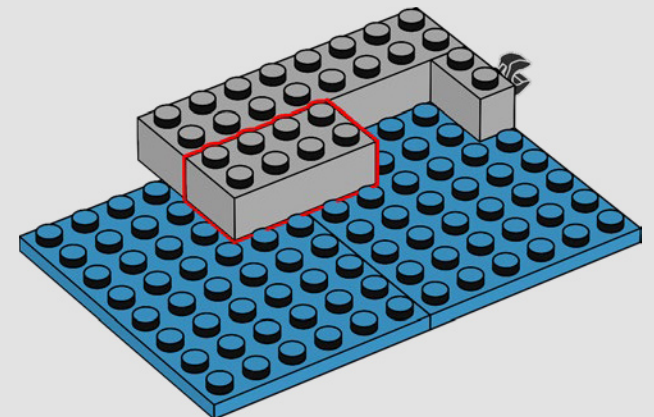

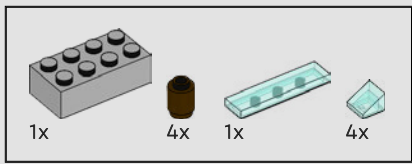

122

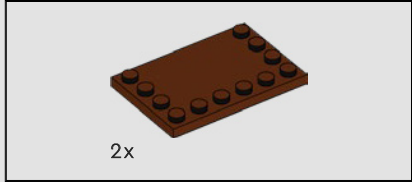
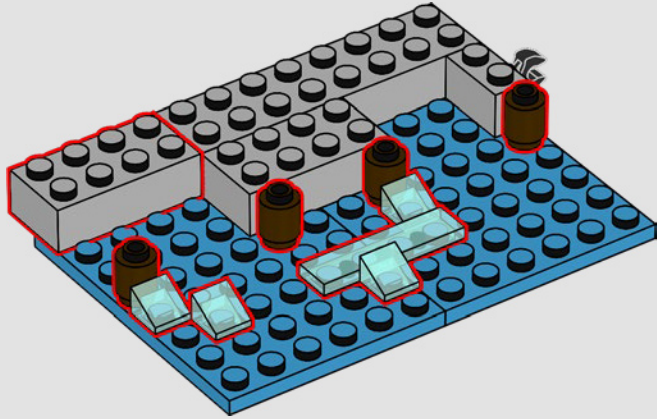

123

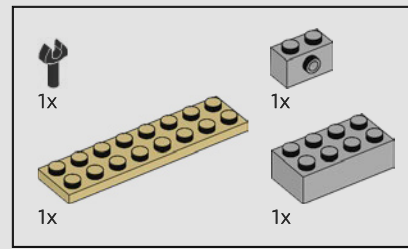
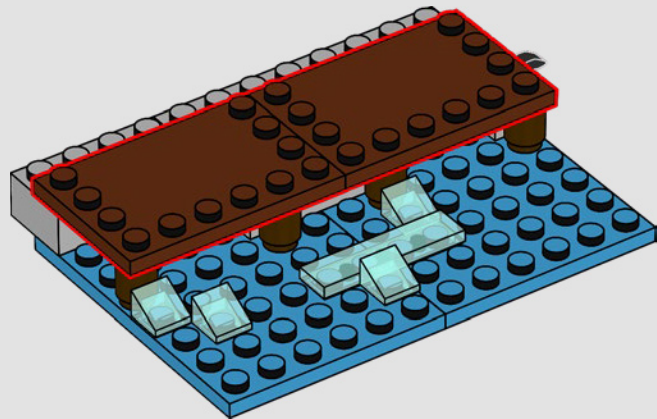

124

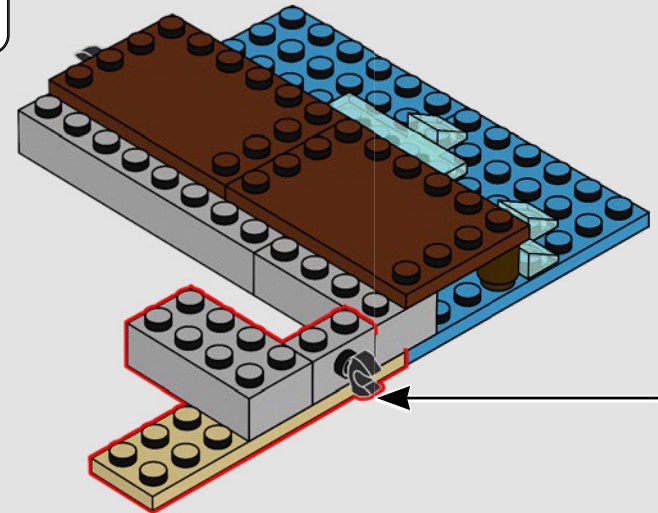
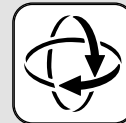
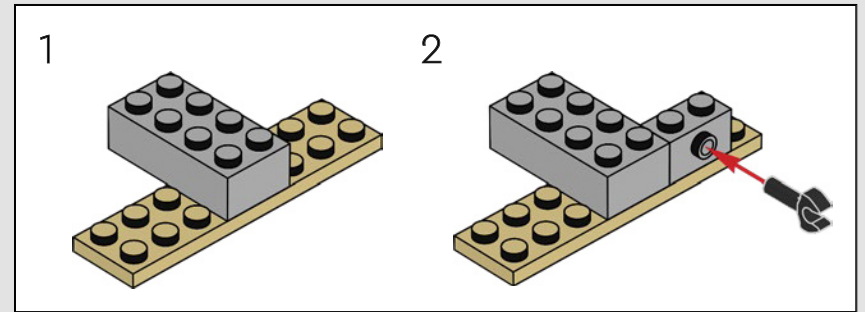

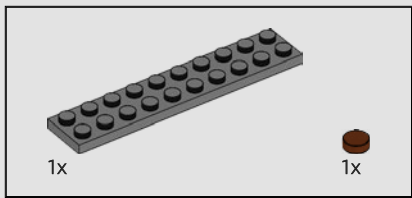

127

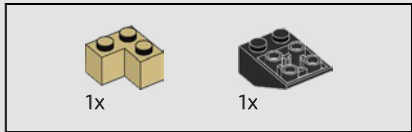
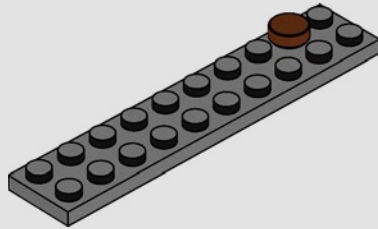

128

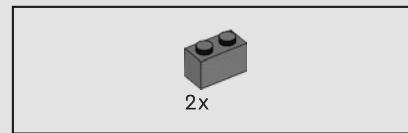
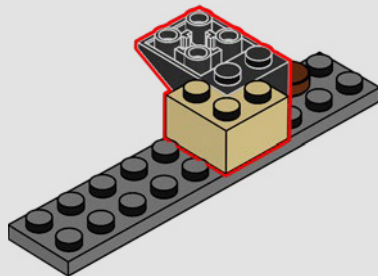

129

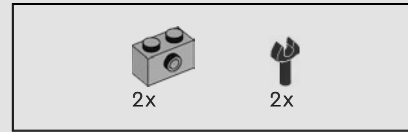
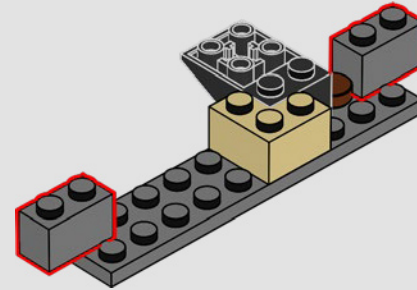

130

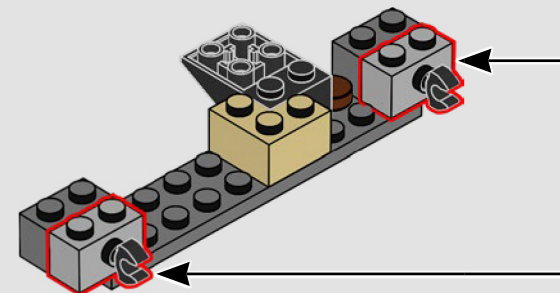
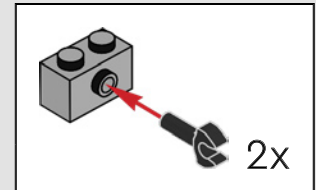

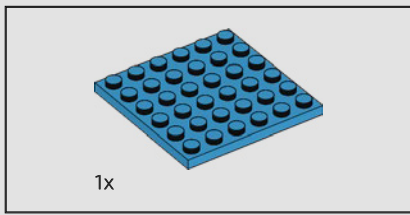

131

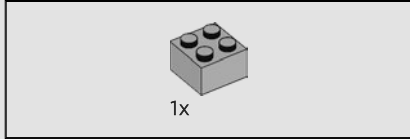
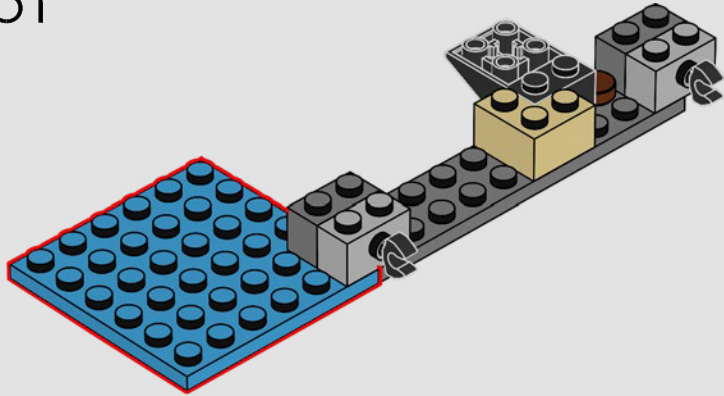

132

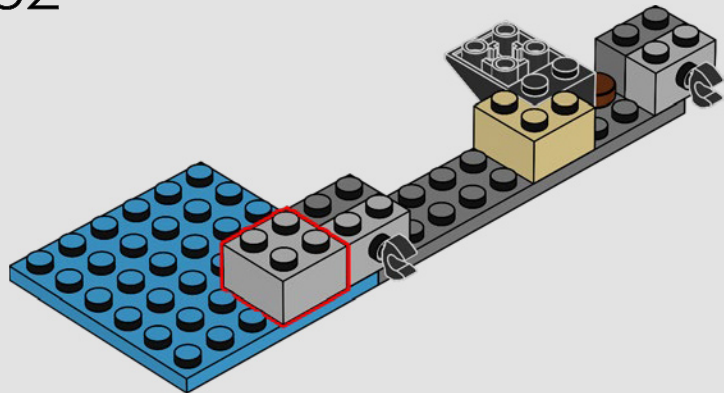

133

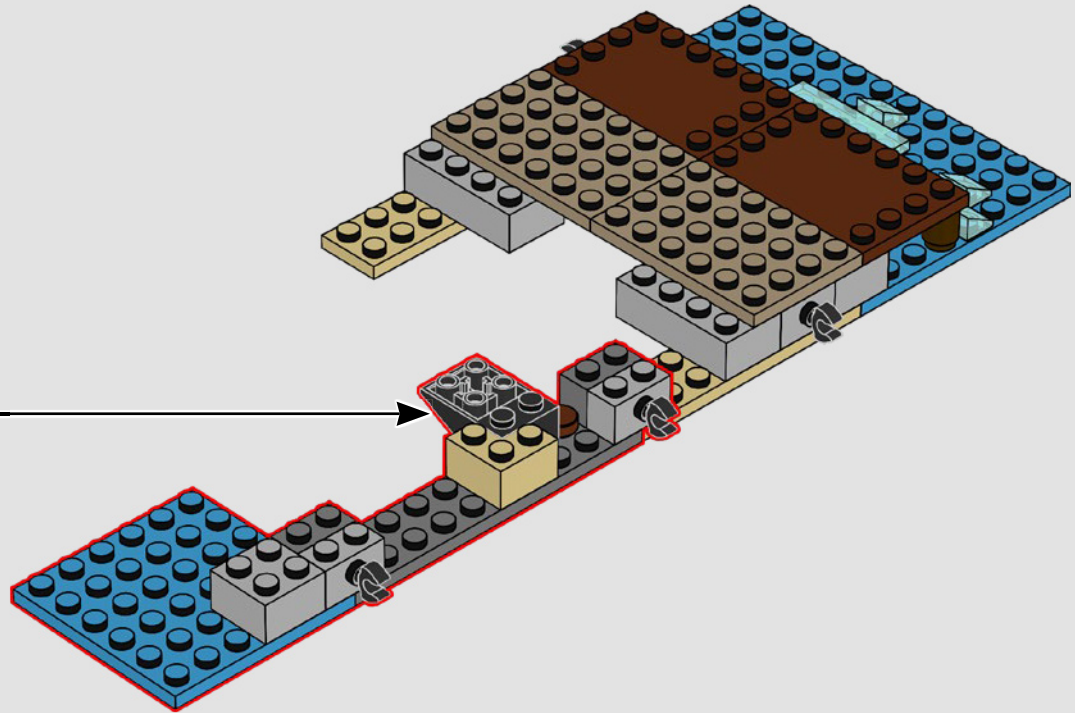

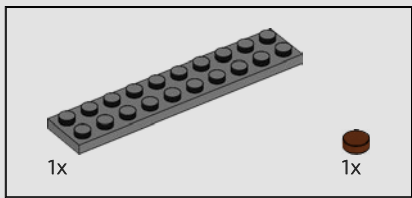

134

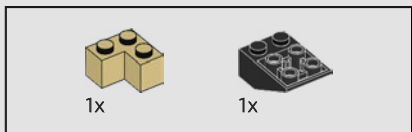
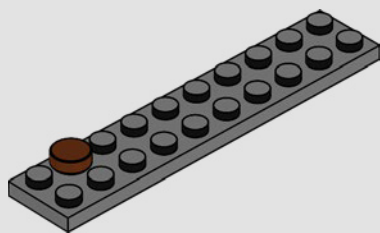

135

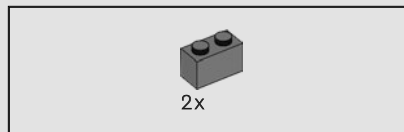
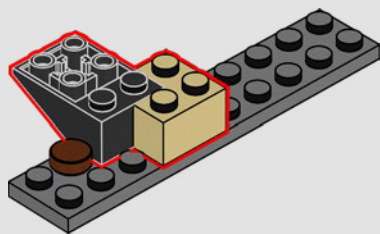

136

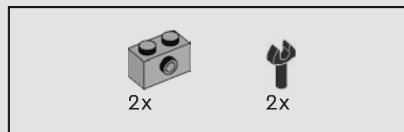
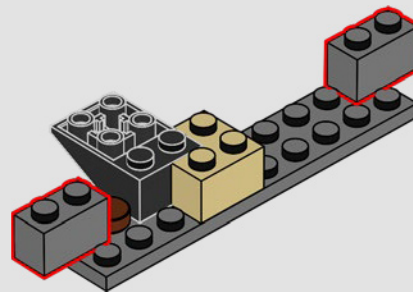

137

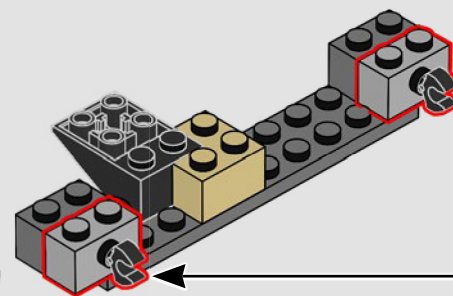
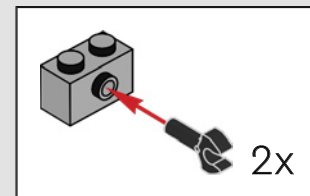

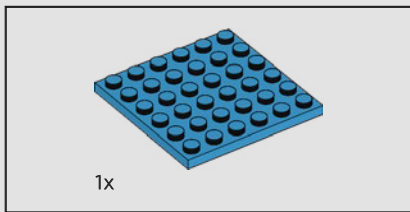

138

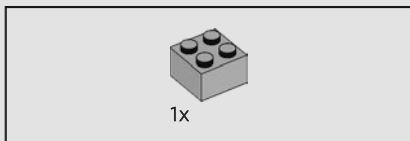
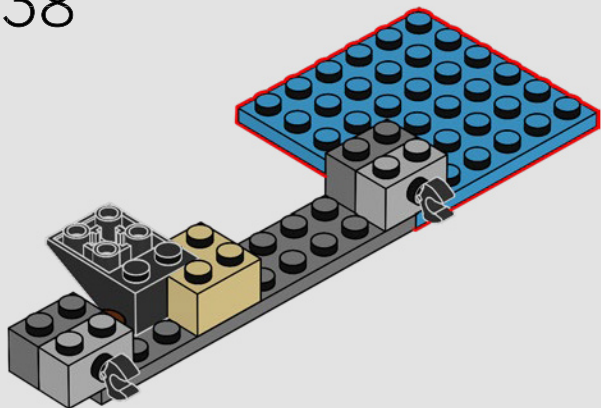

139

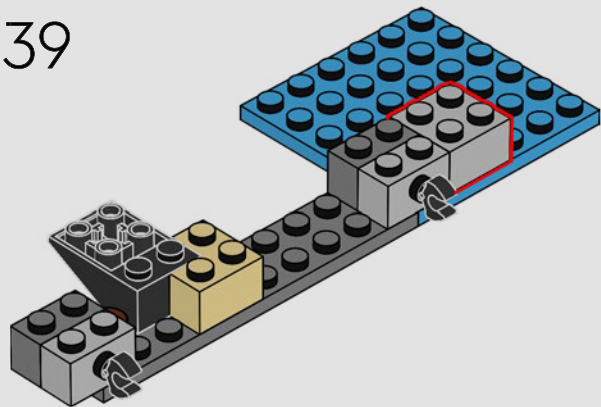

140

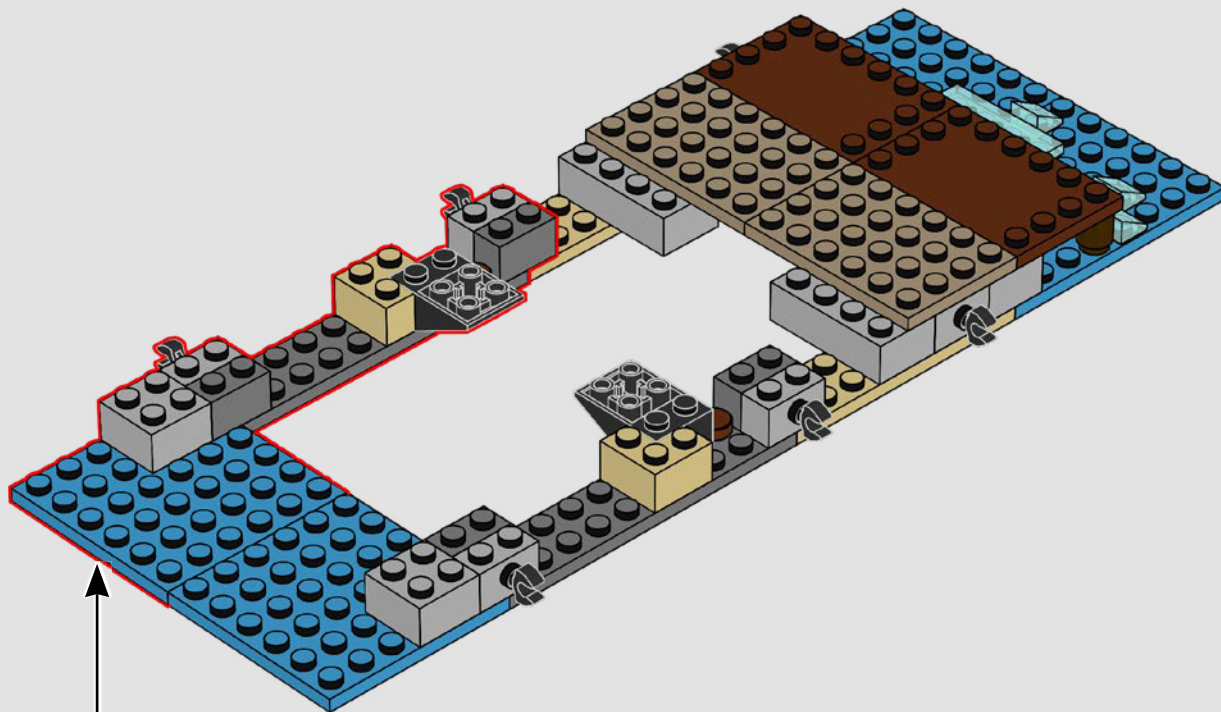

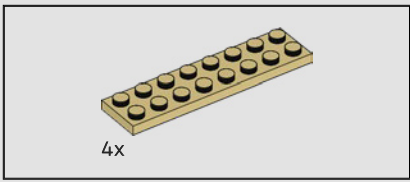

141

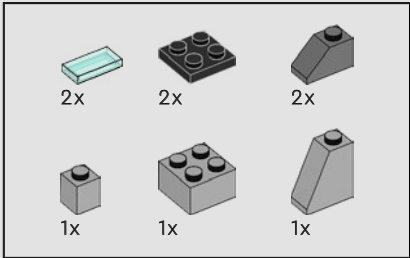
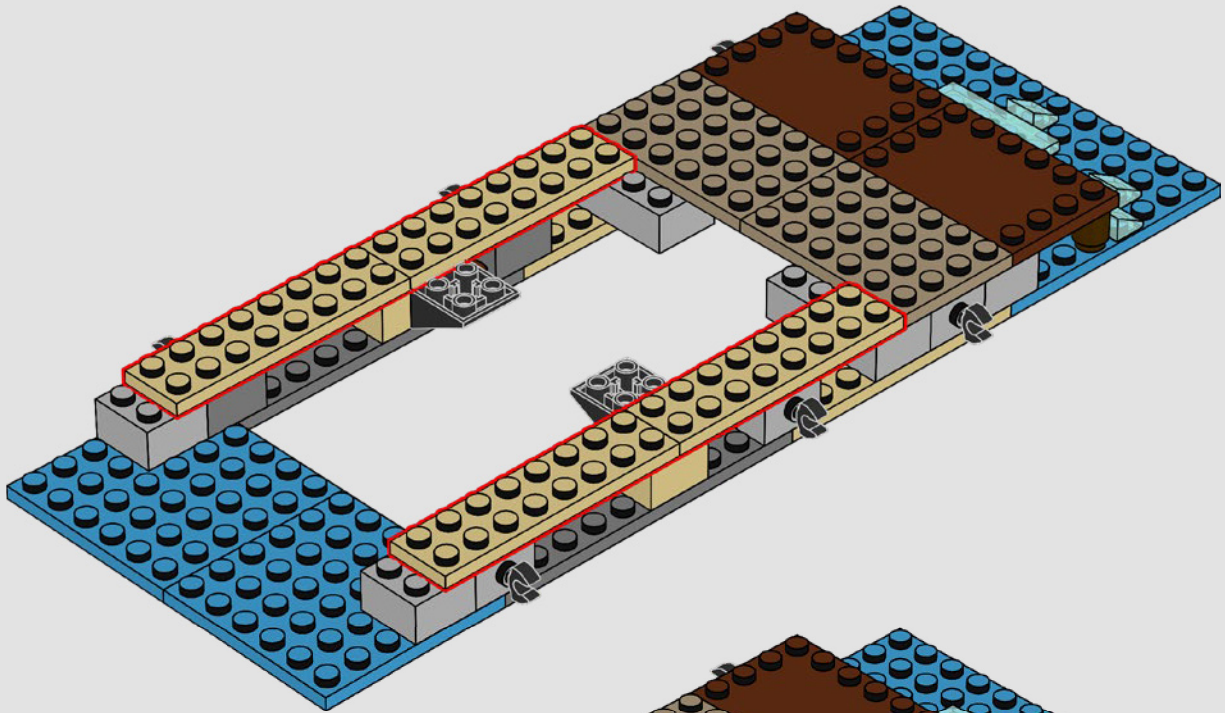

142

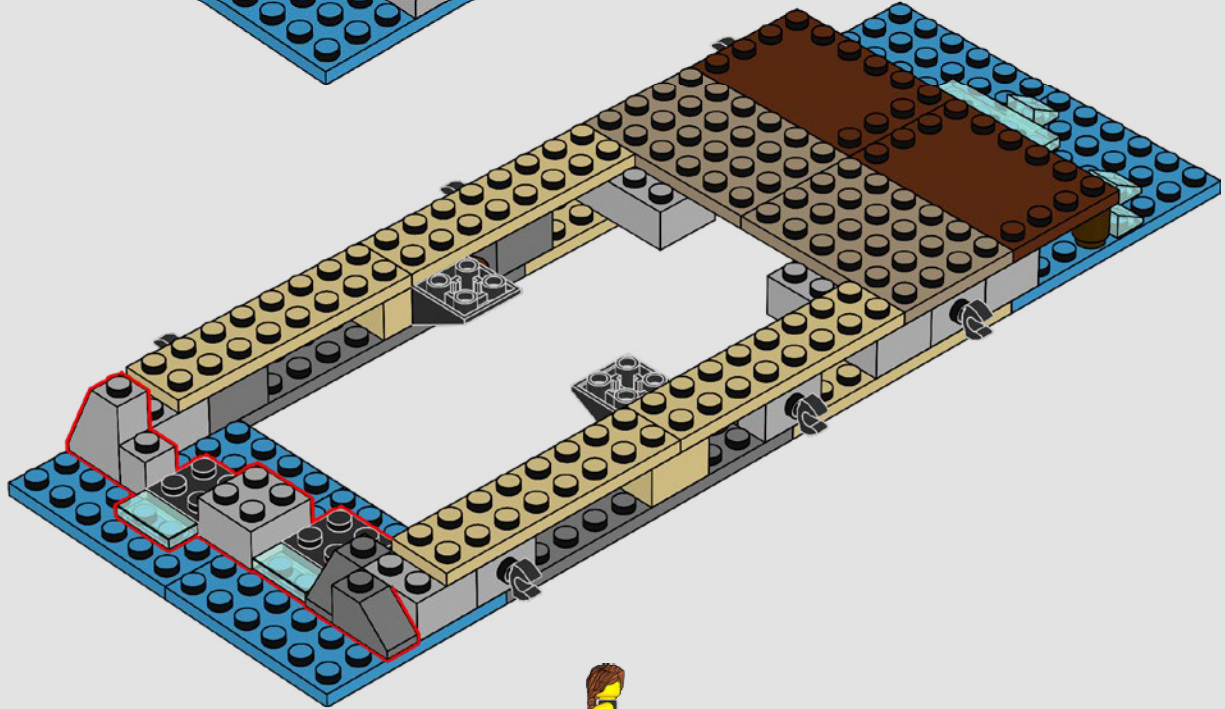

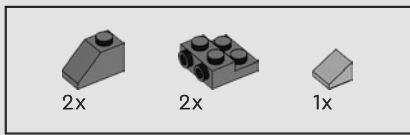

143

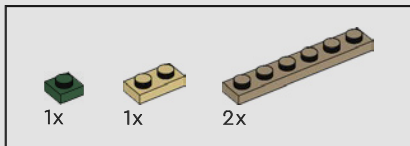
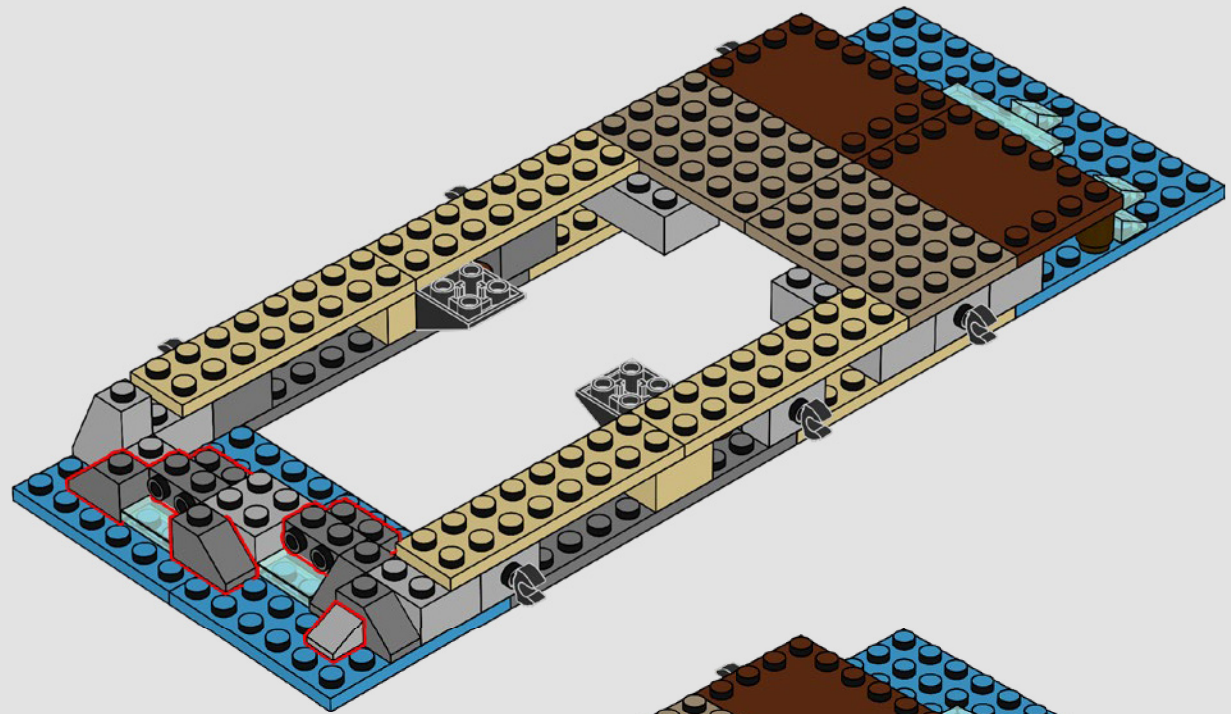

144

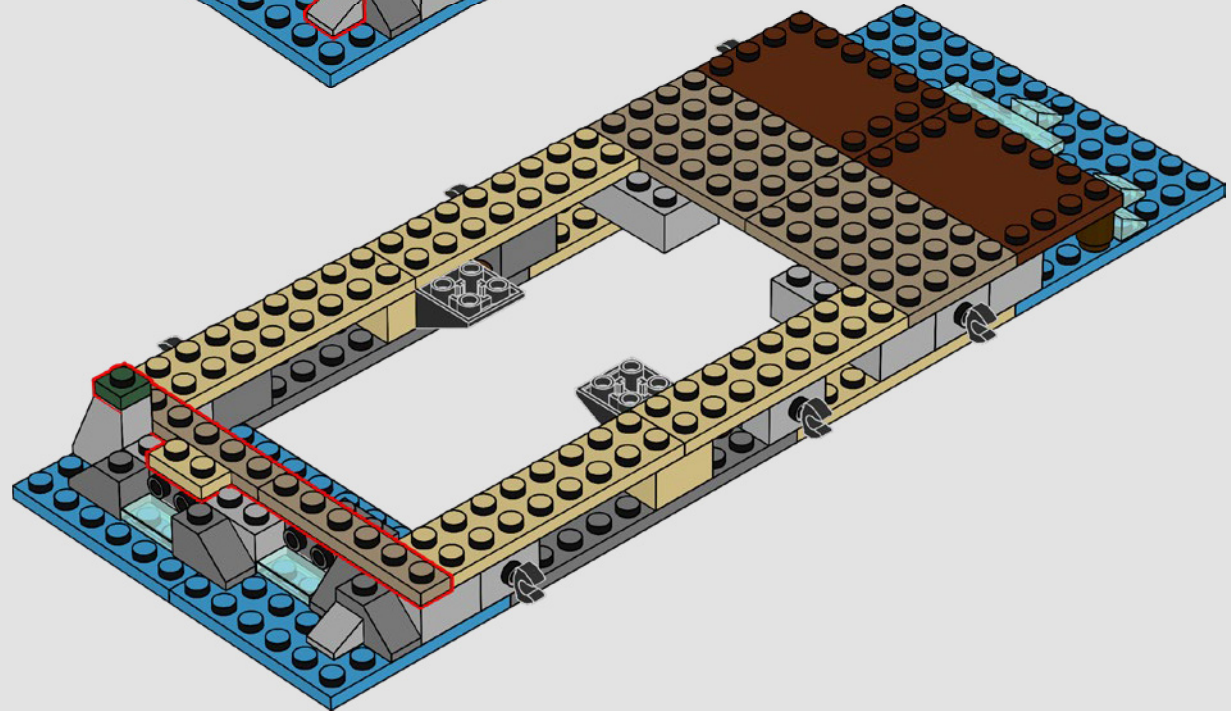

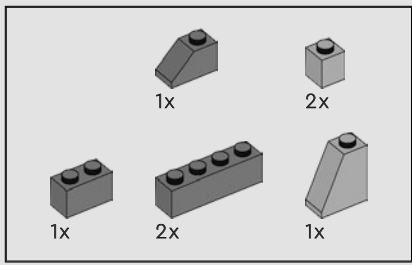

145

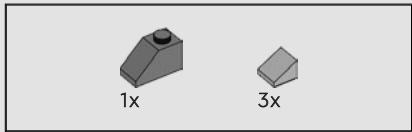
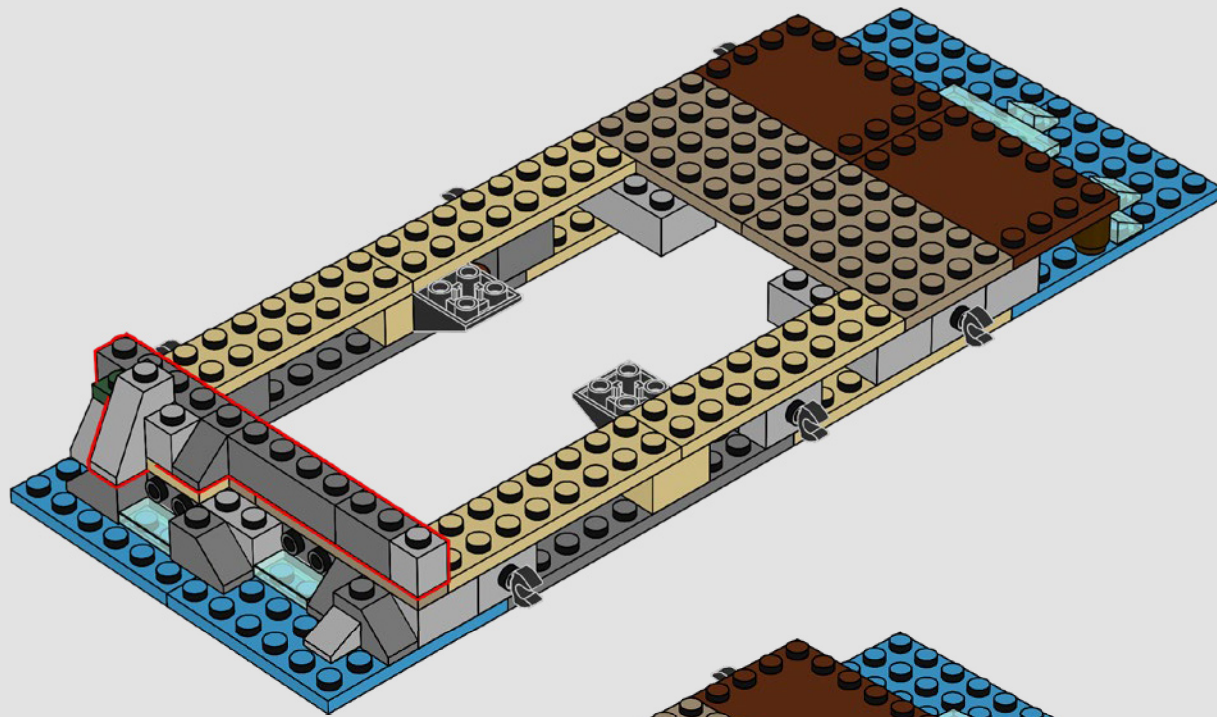

146

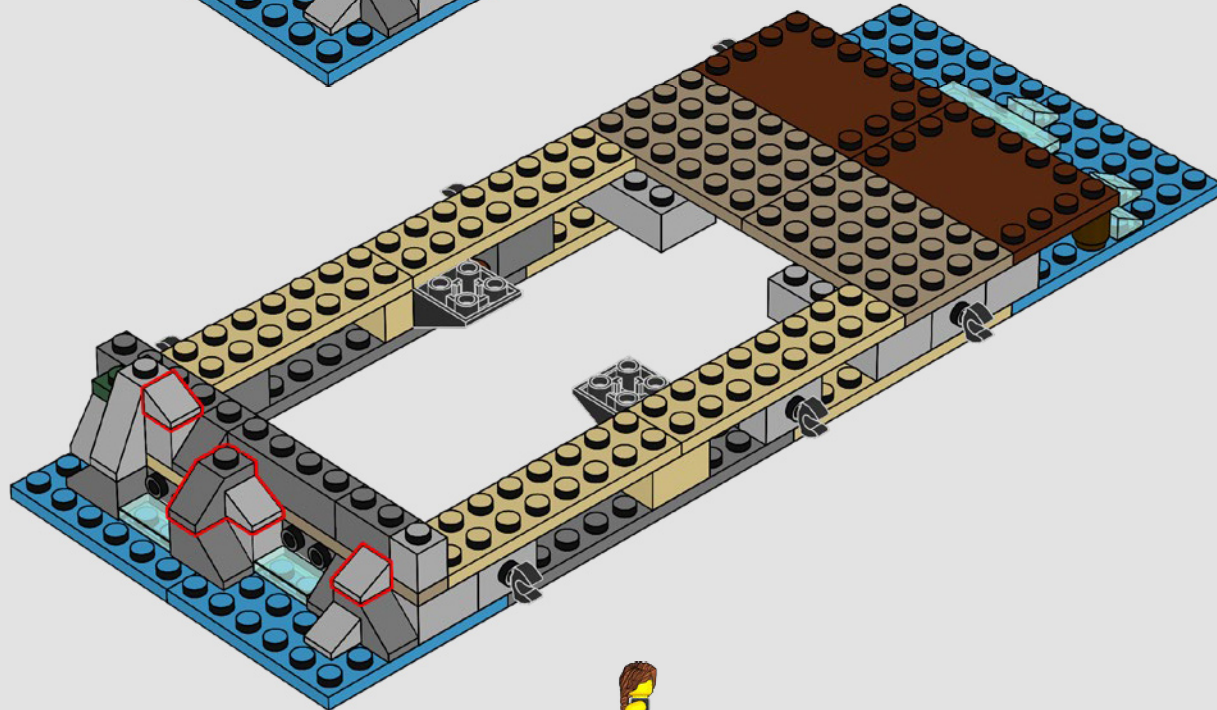



147

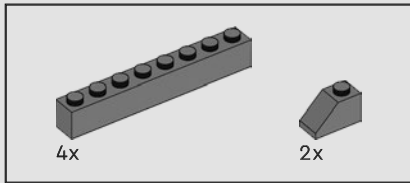
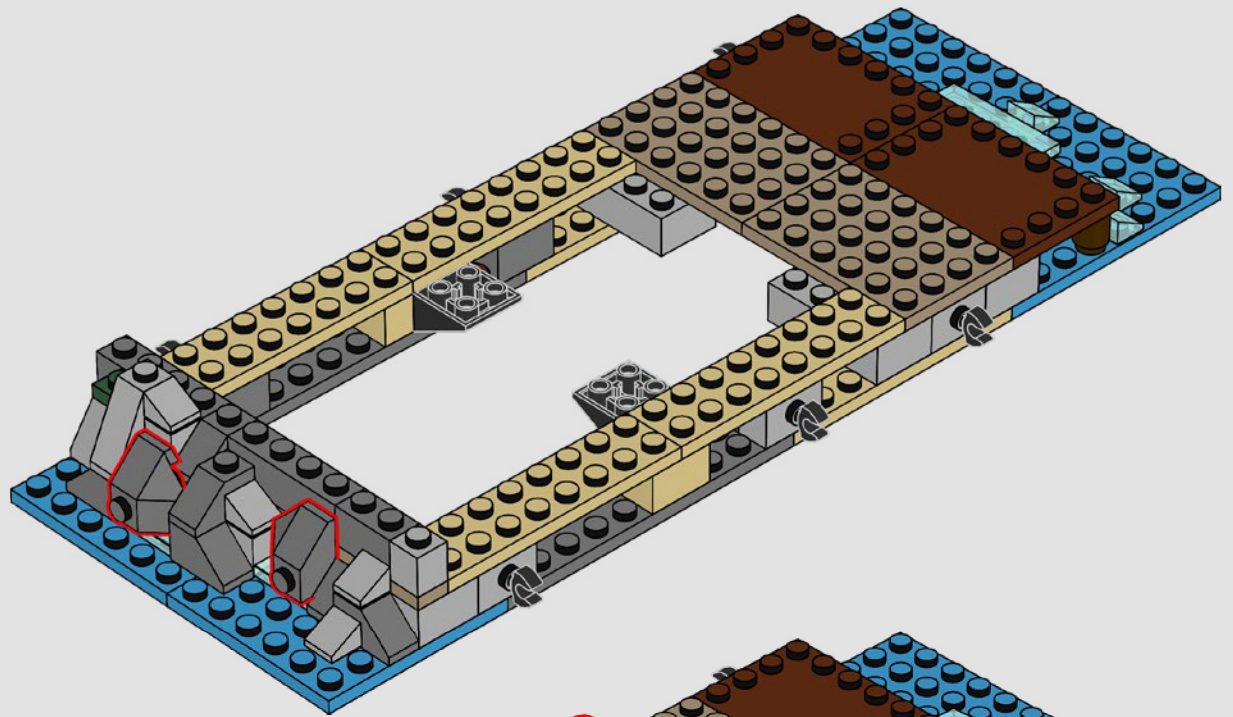

148

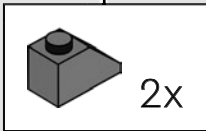
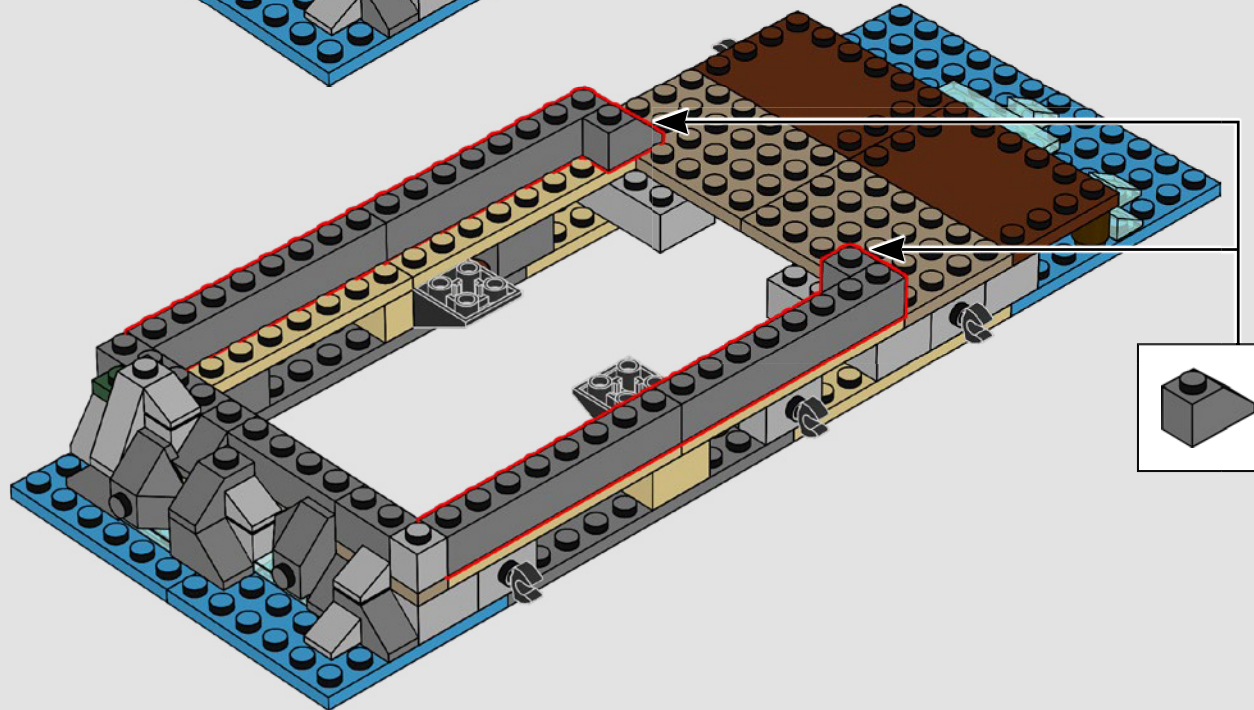

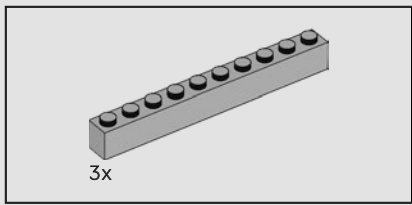

149

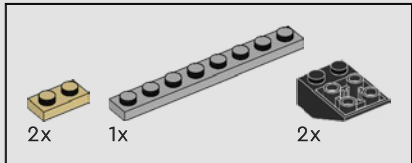
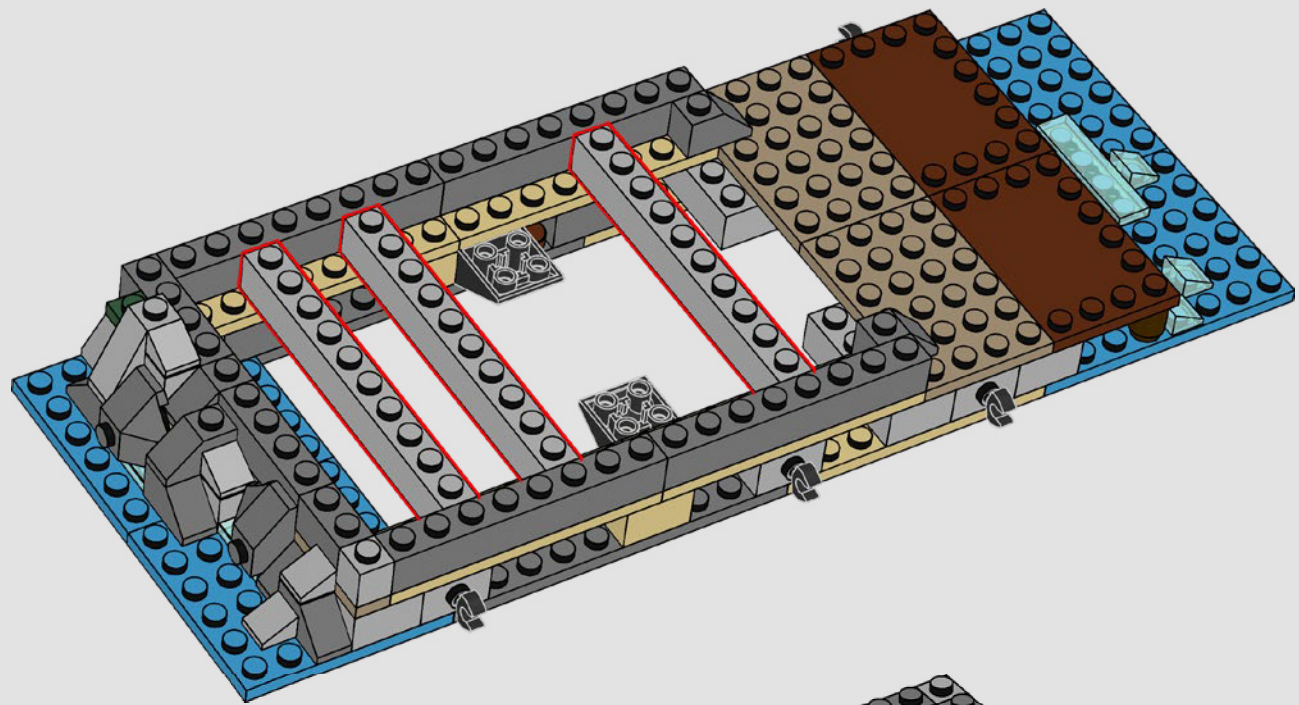

150

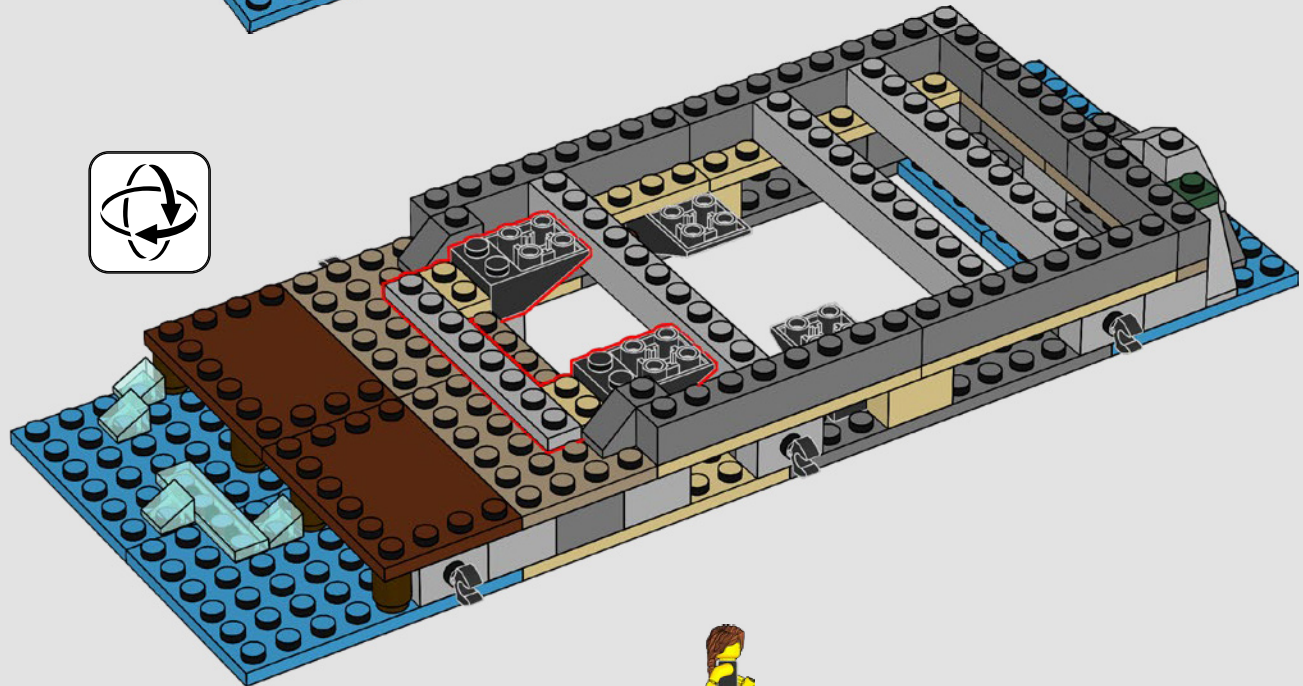
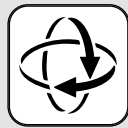

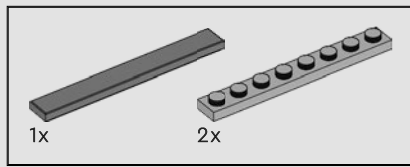

151

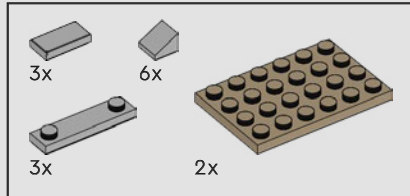
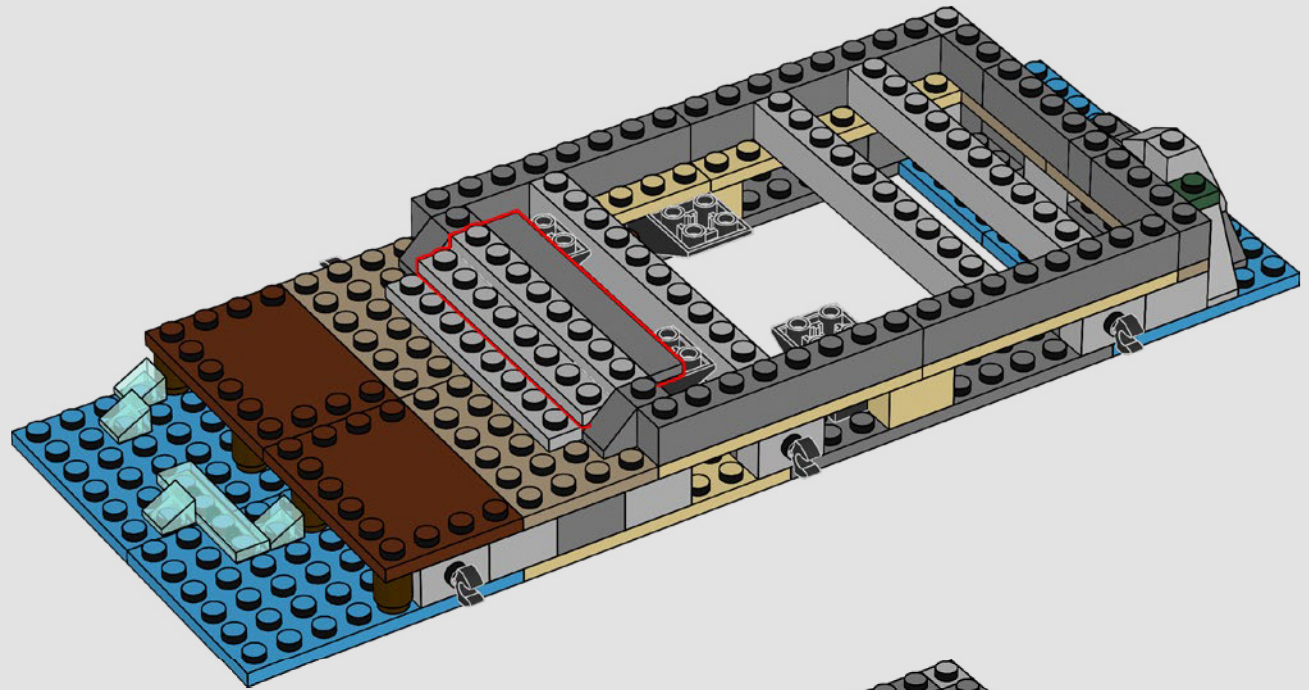

152

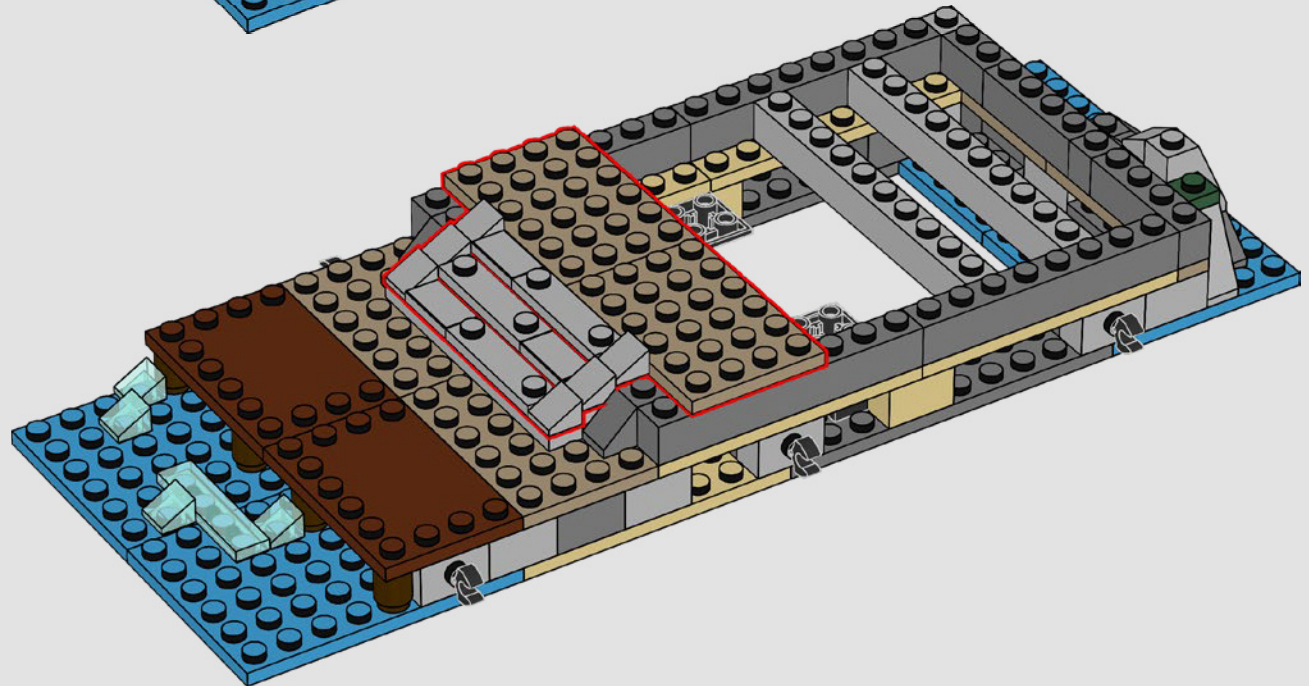

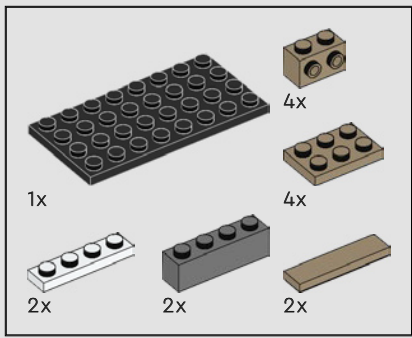

153

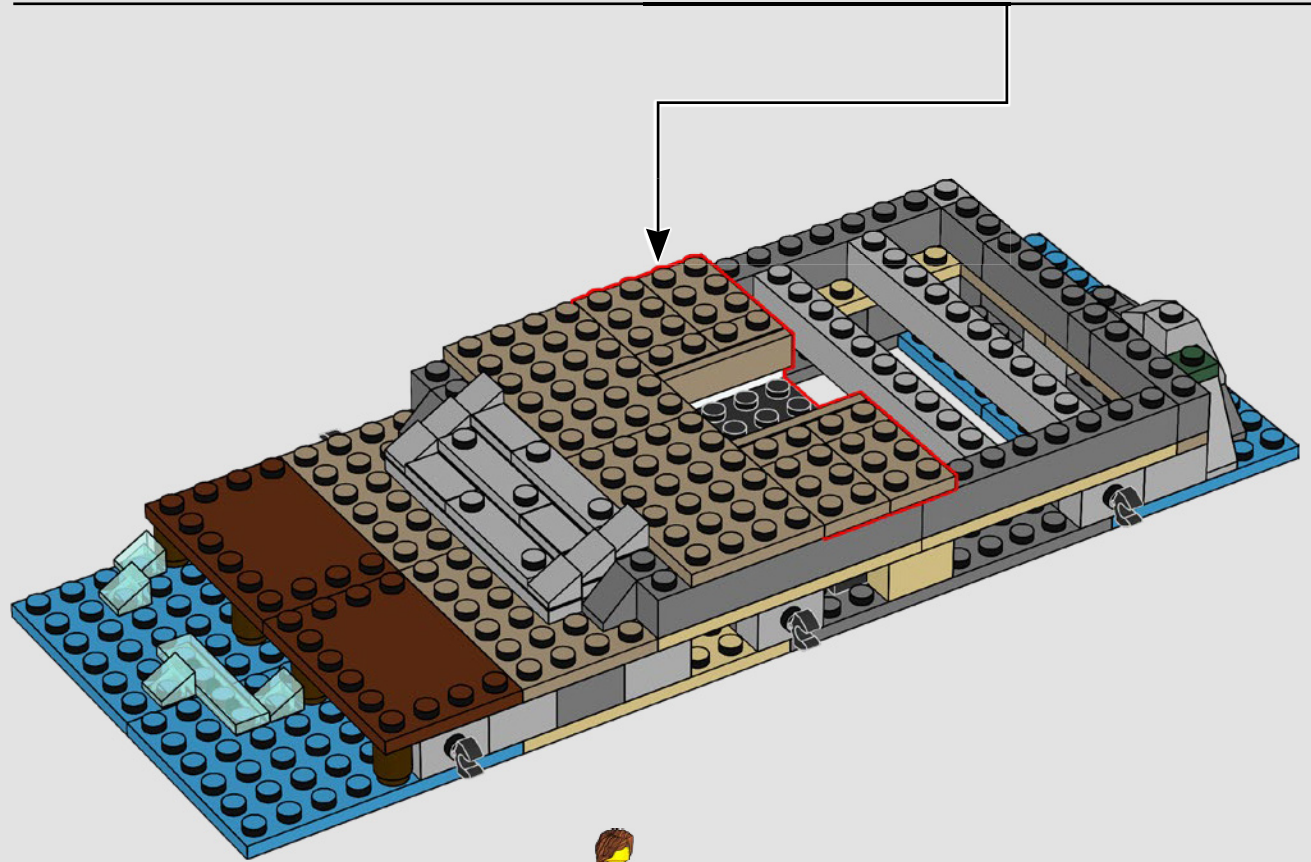
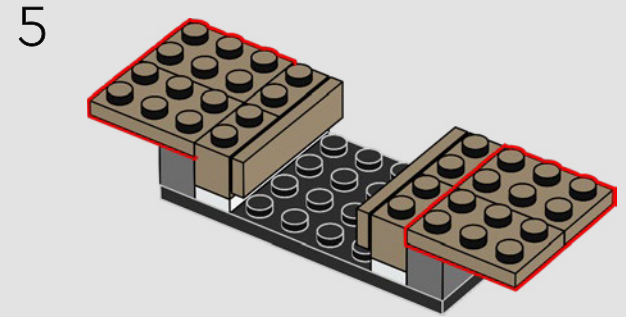
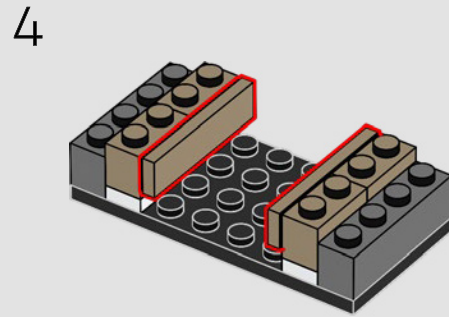
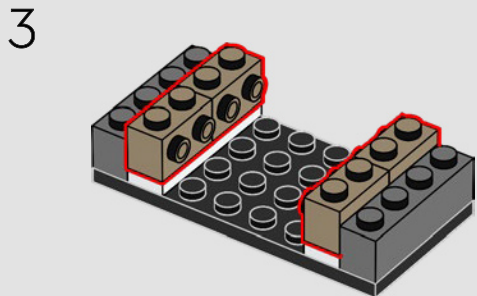
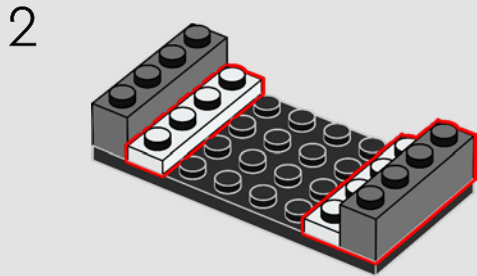
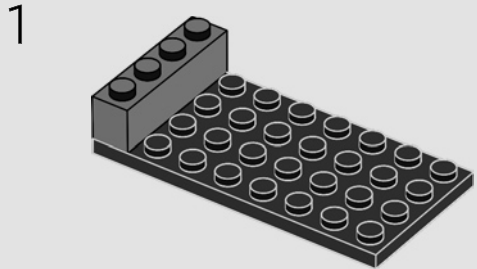

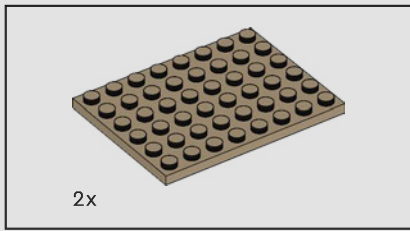

154

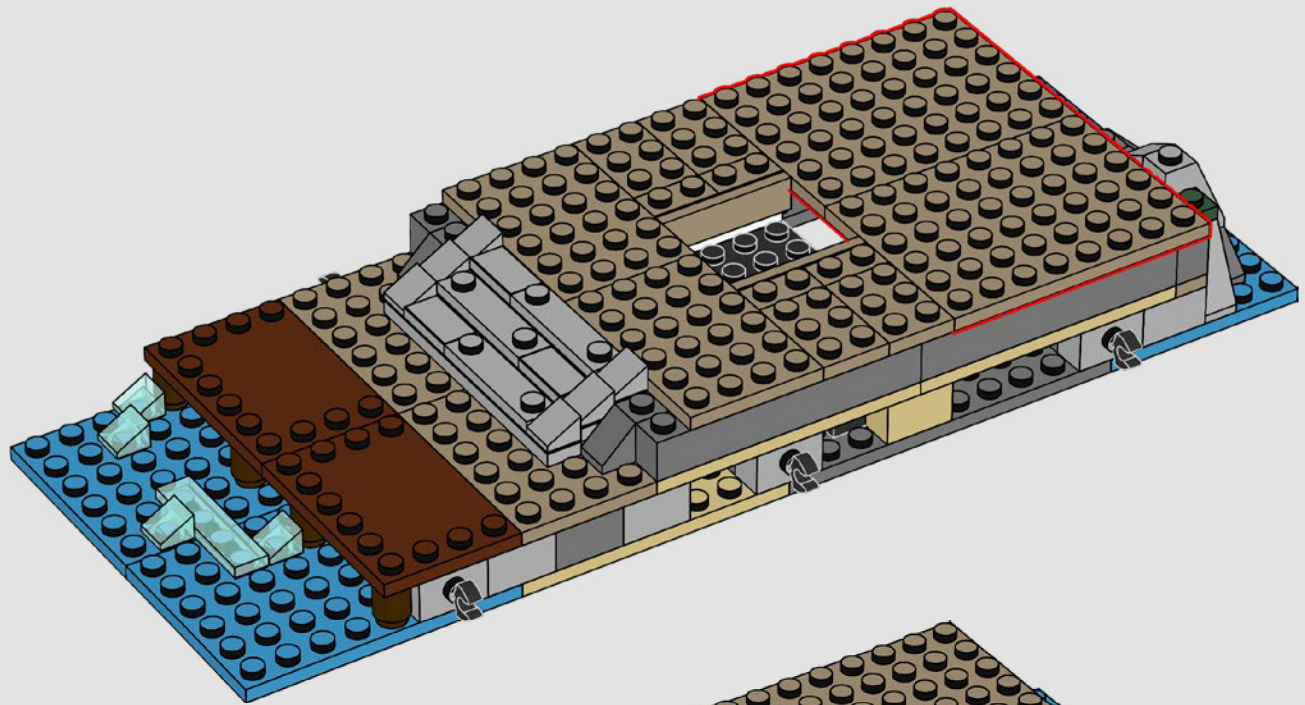

155

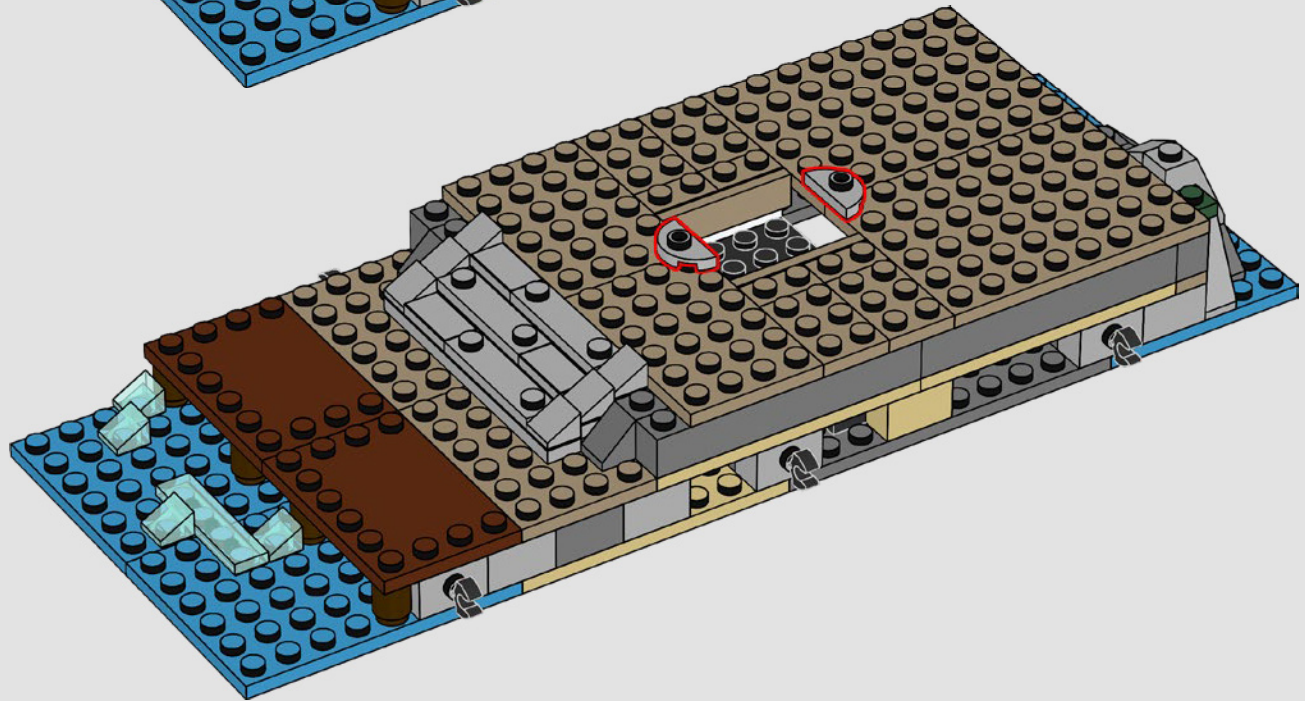

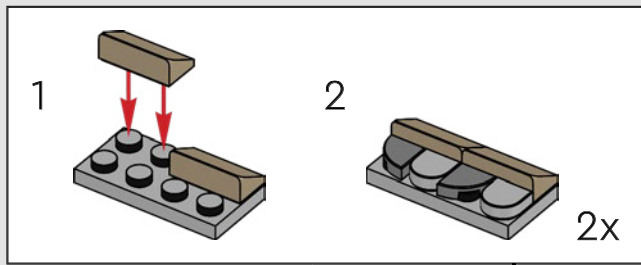
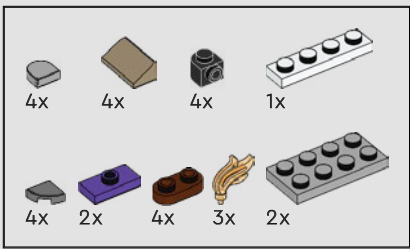

156

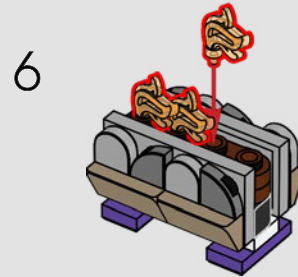
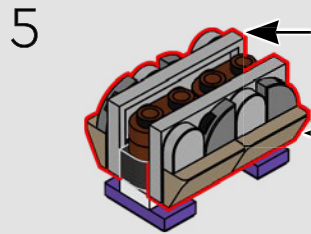

1

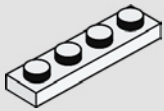

2

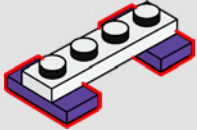

3

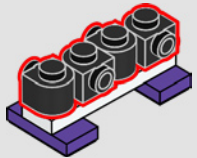

4

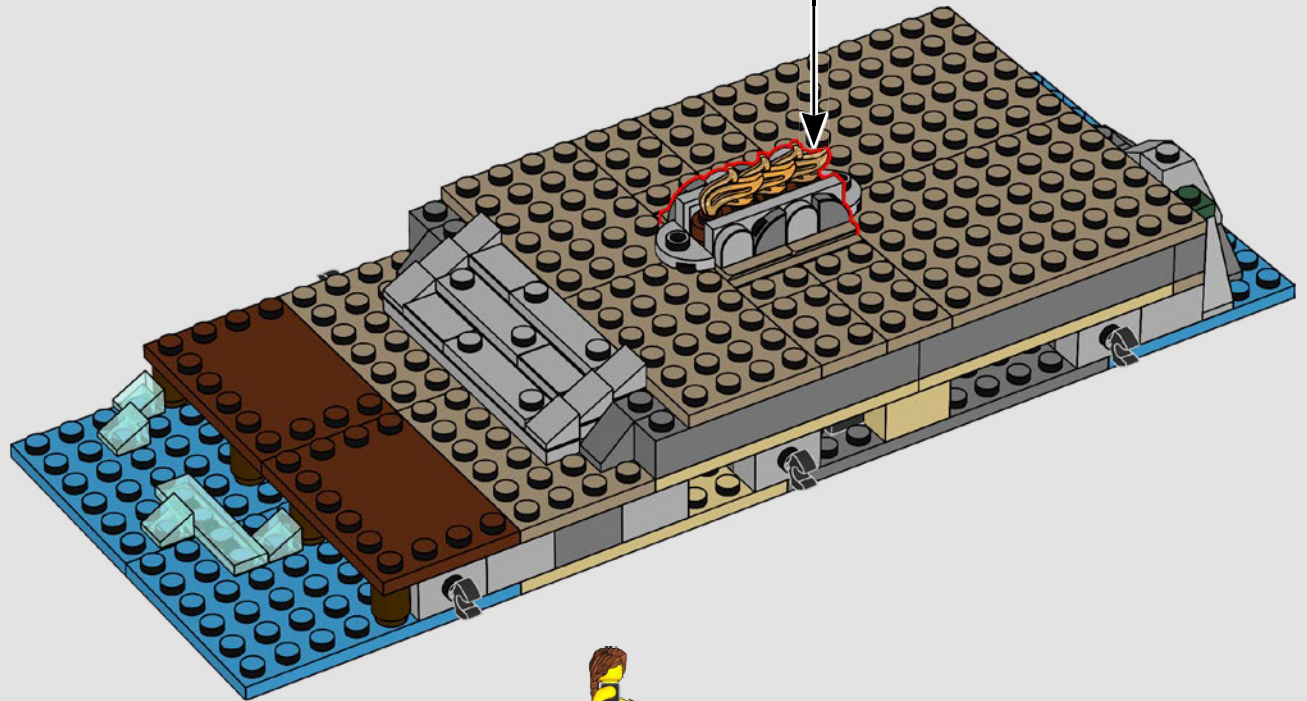
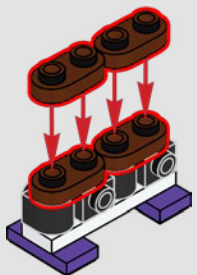

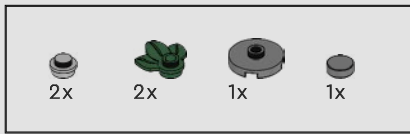

157

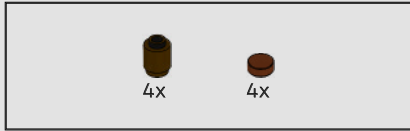
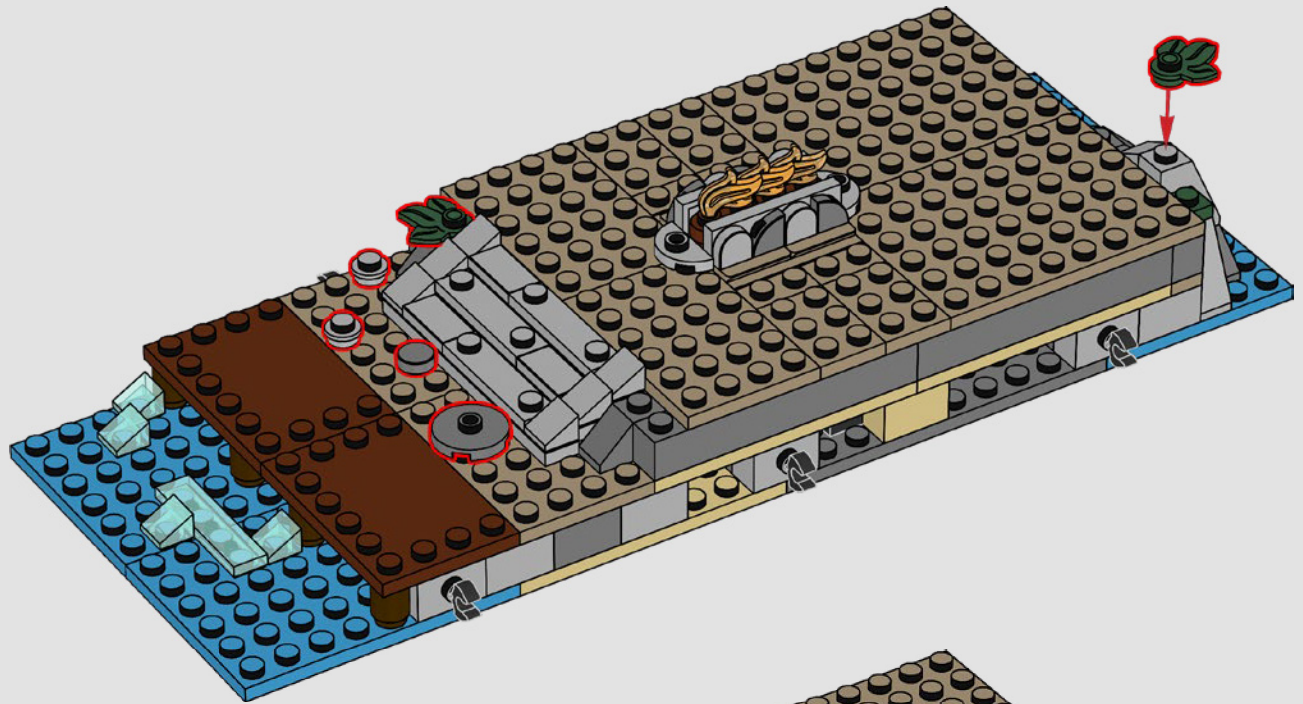

158

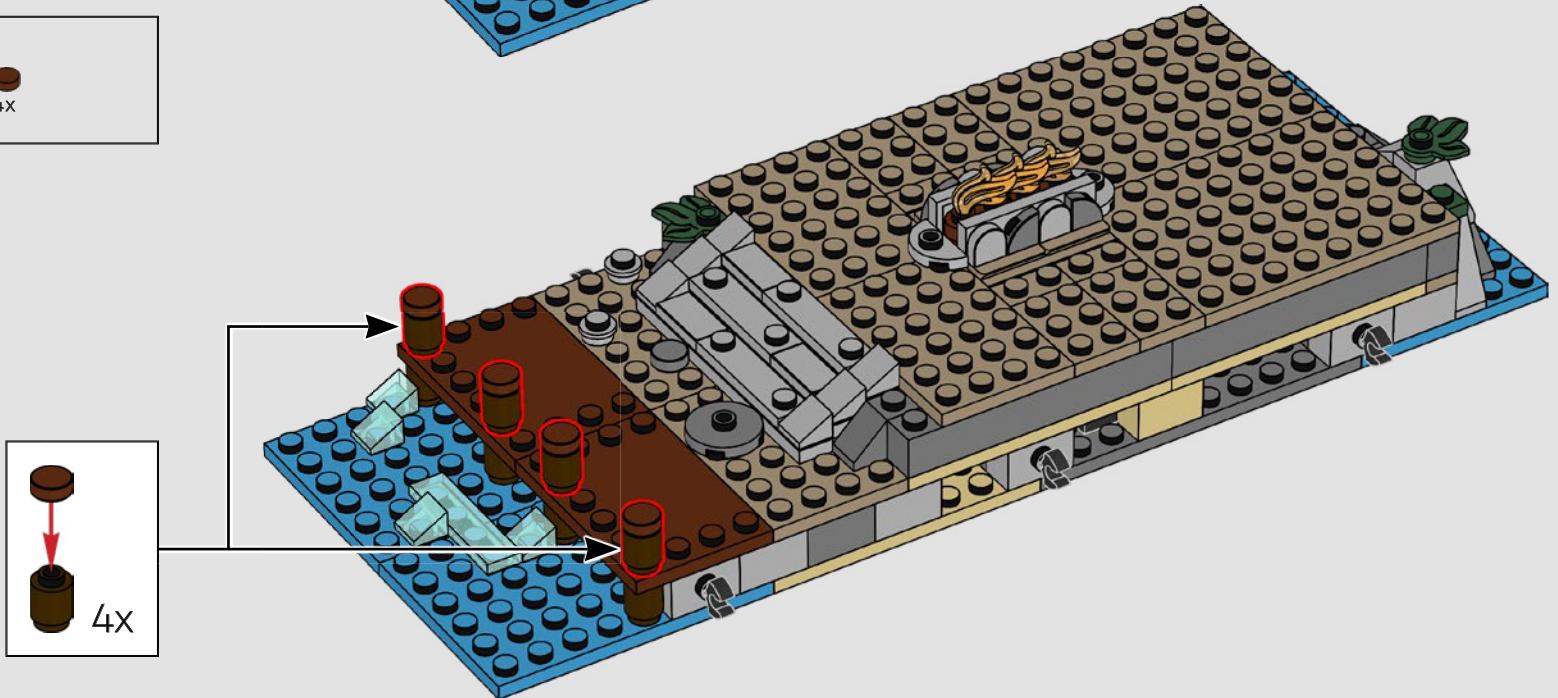



159

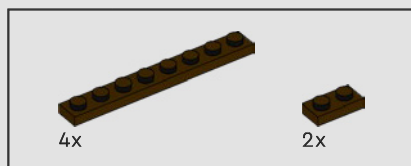
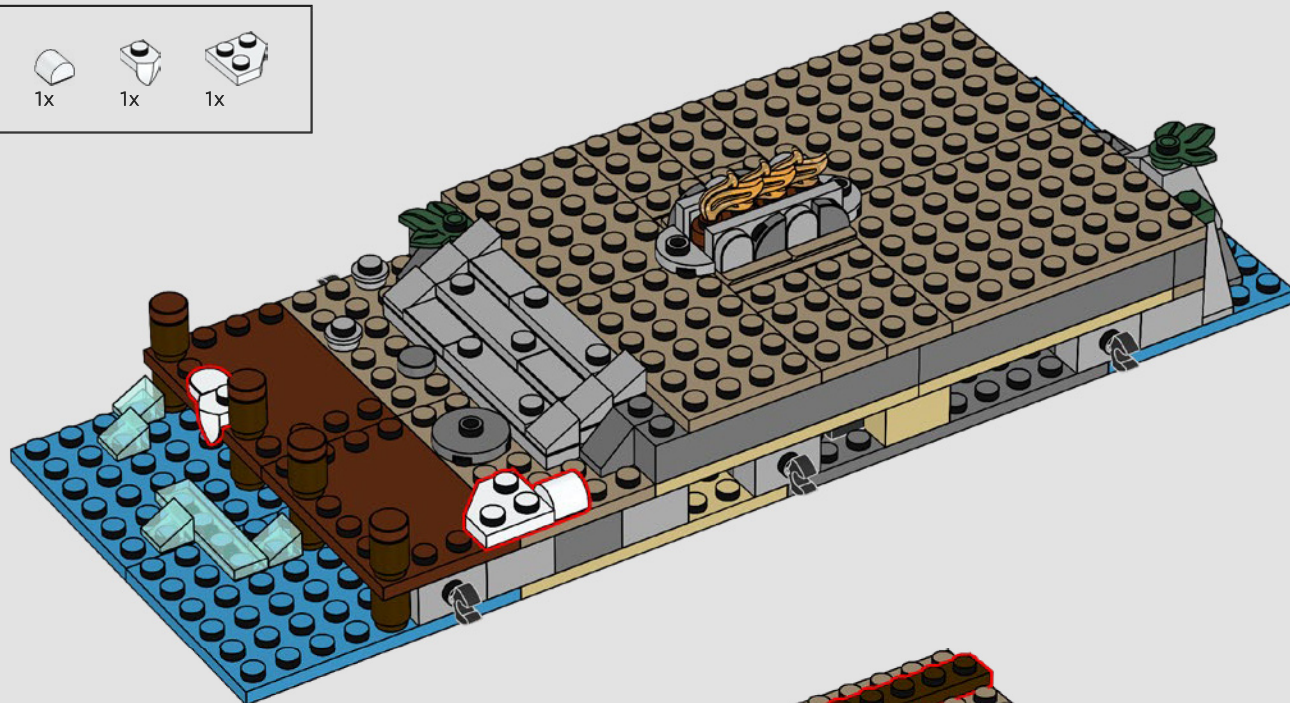

160

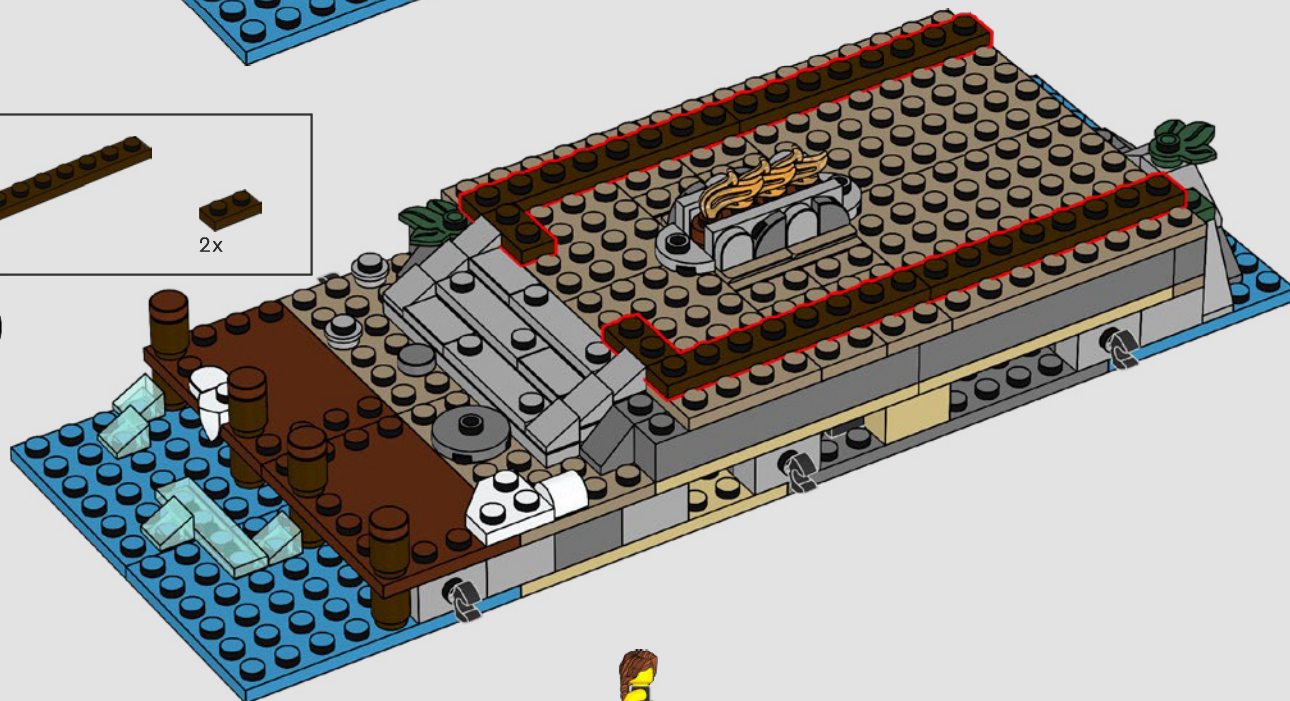

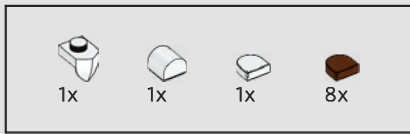

161

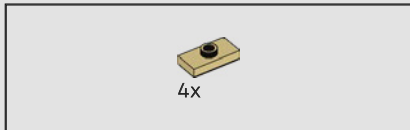
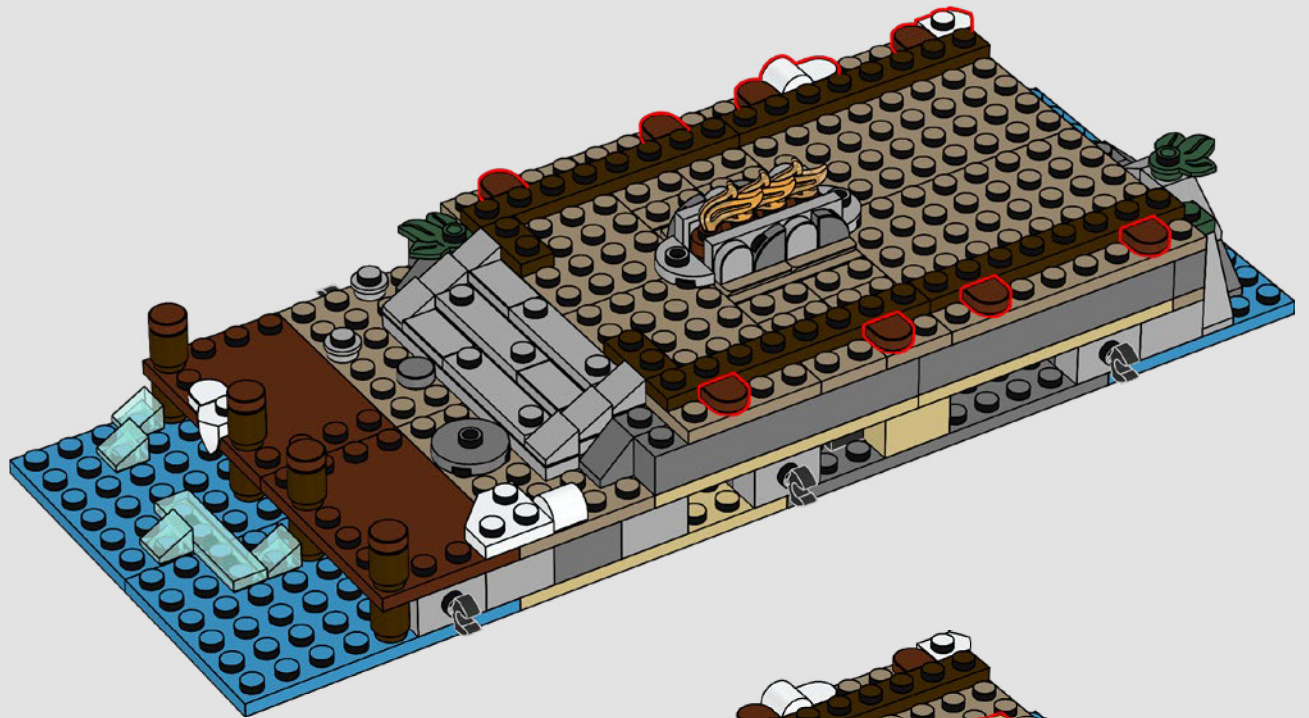

162

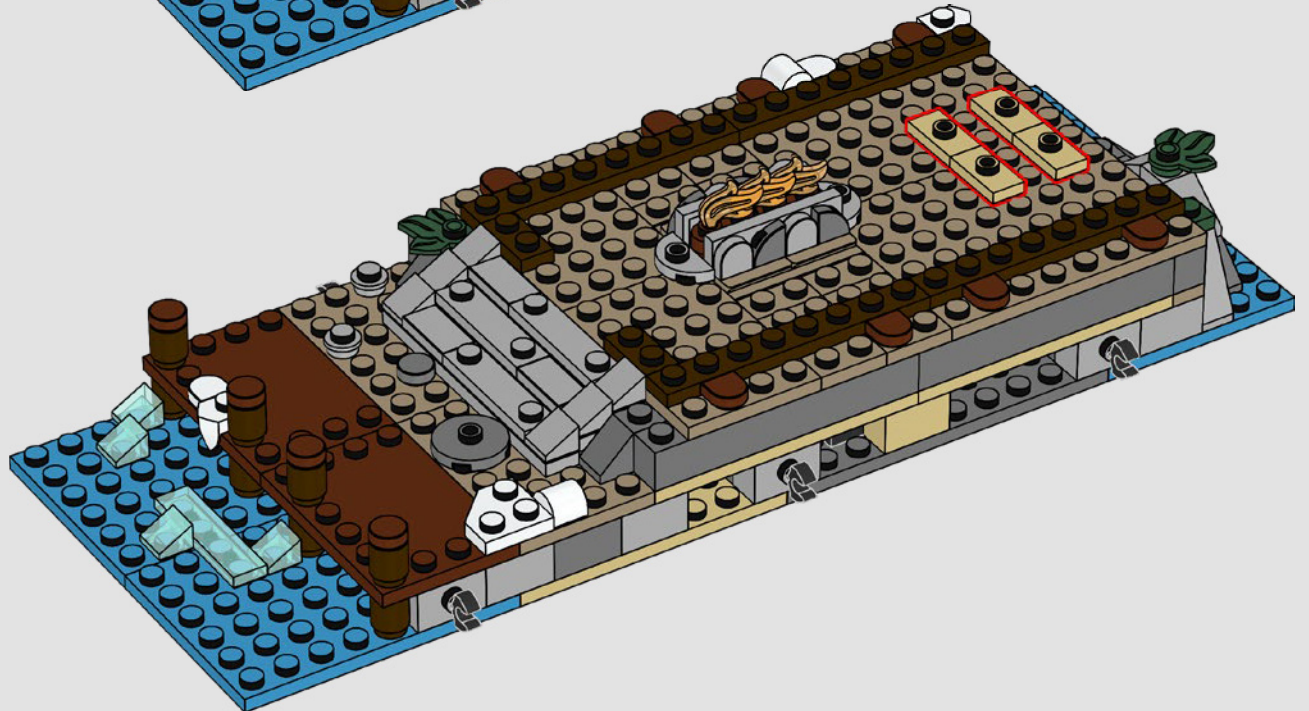

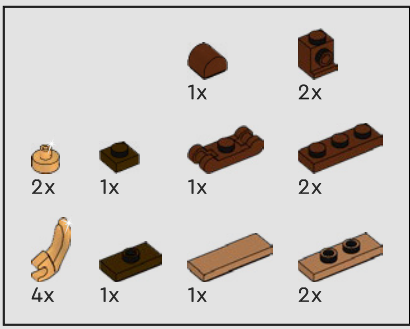

163

1



2

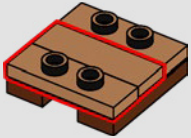

3

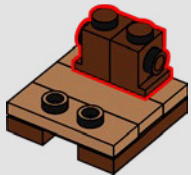

4

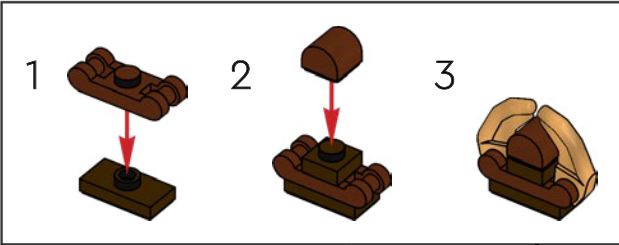
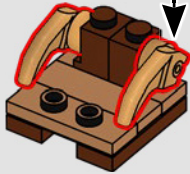
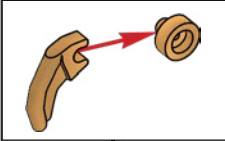

5

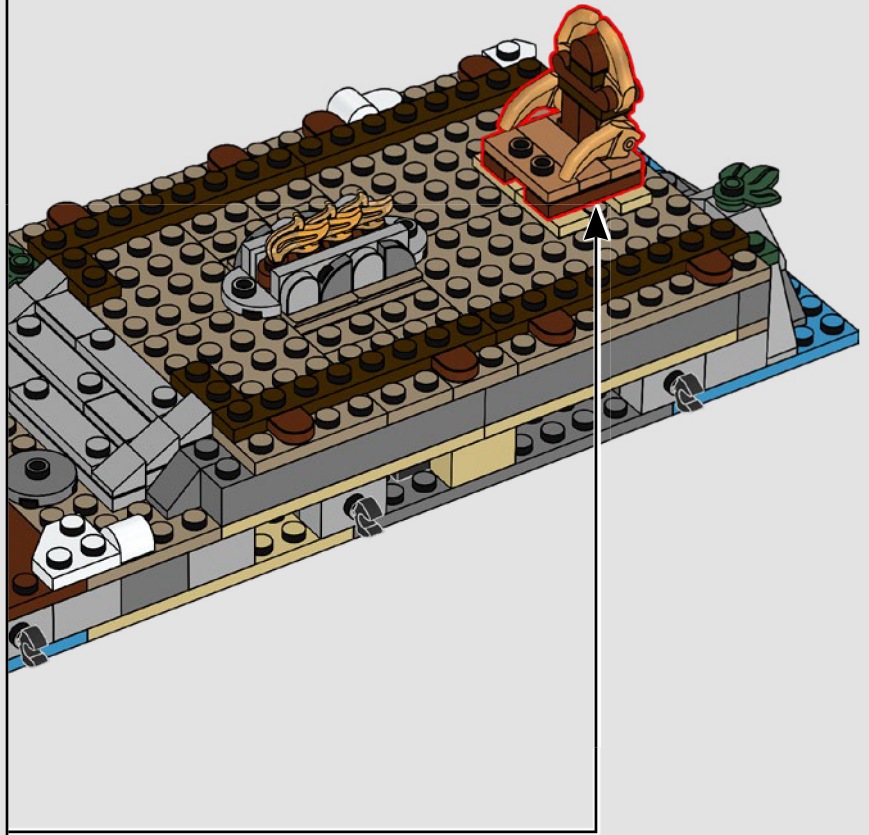

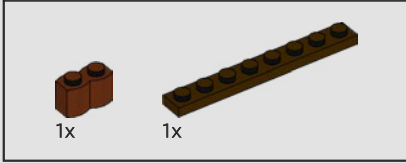
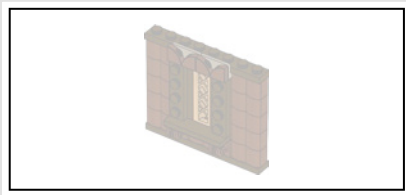

164

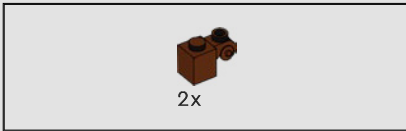
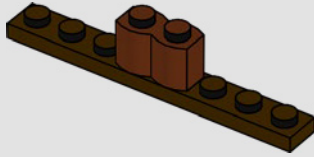

165

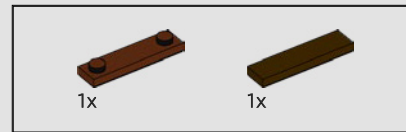
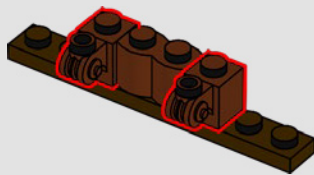

166

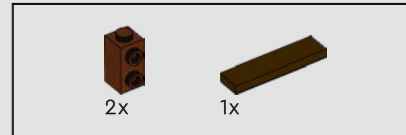
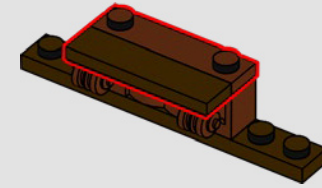

167

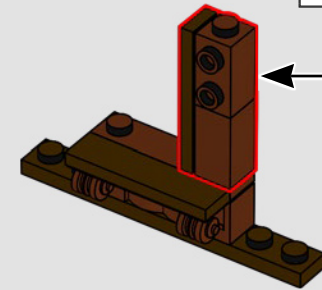
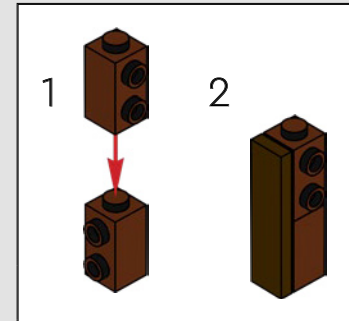



168

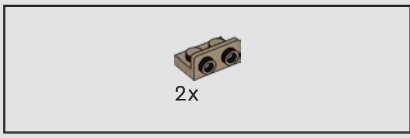
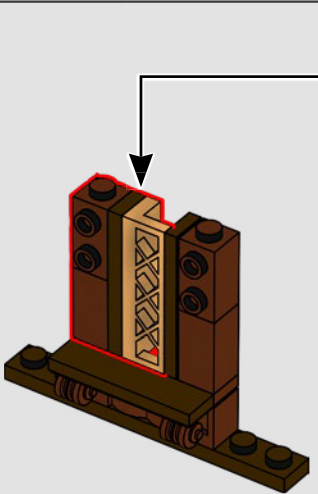
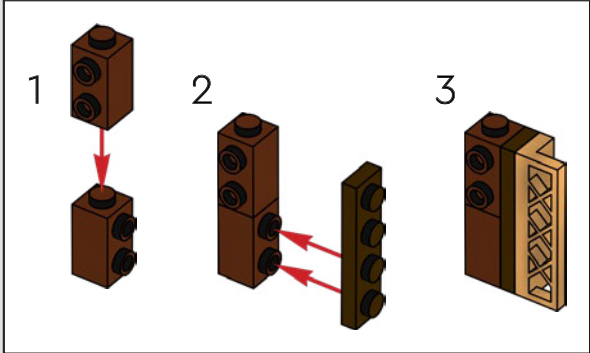

169

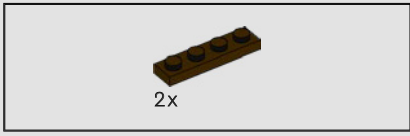
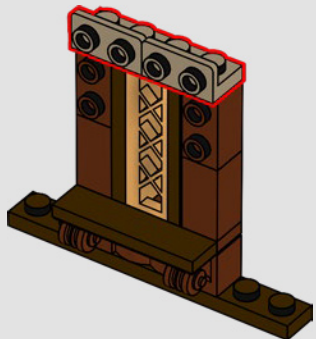

170

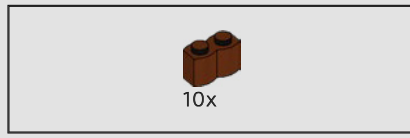
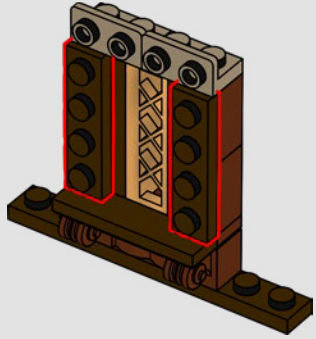

171

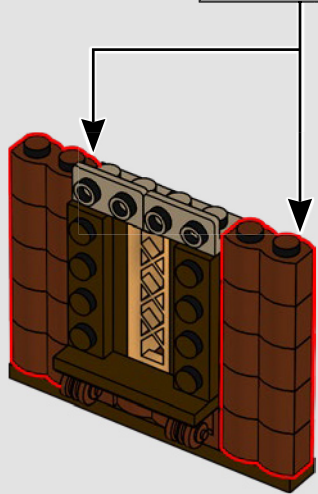
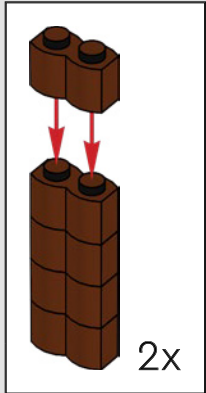

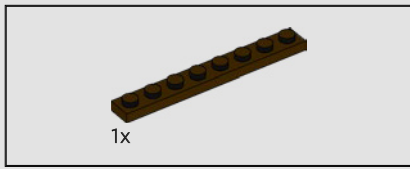

172

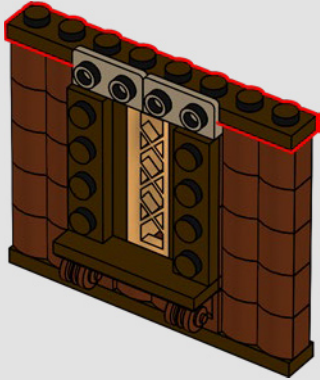

173

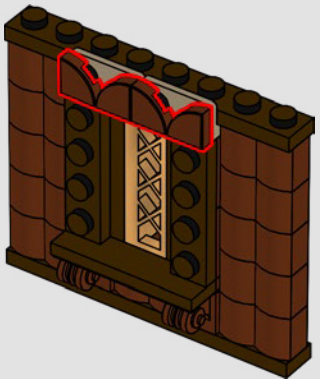

174

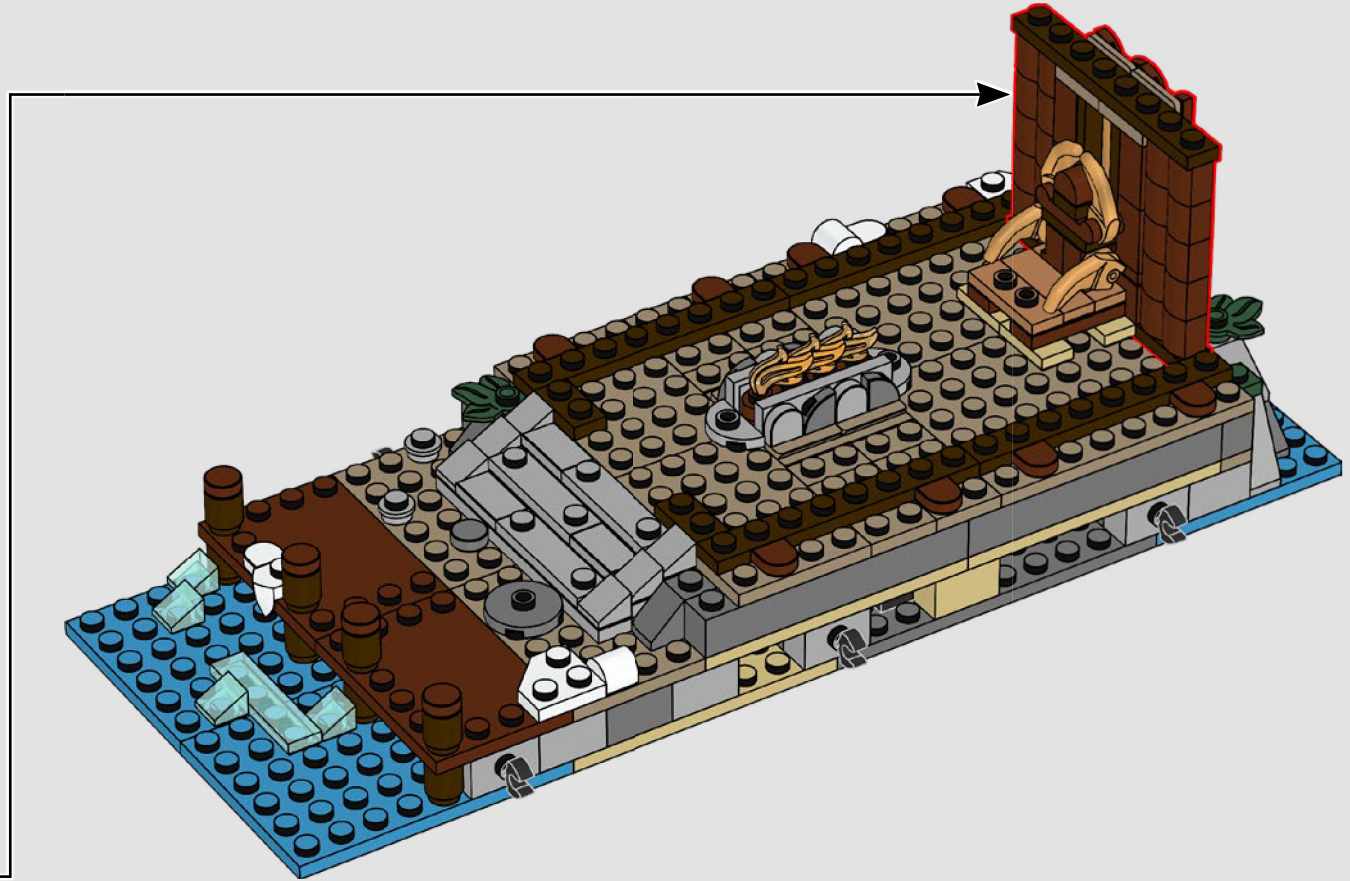

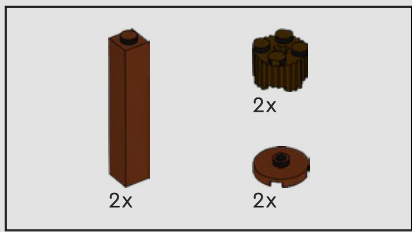

175

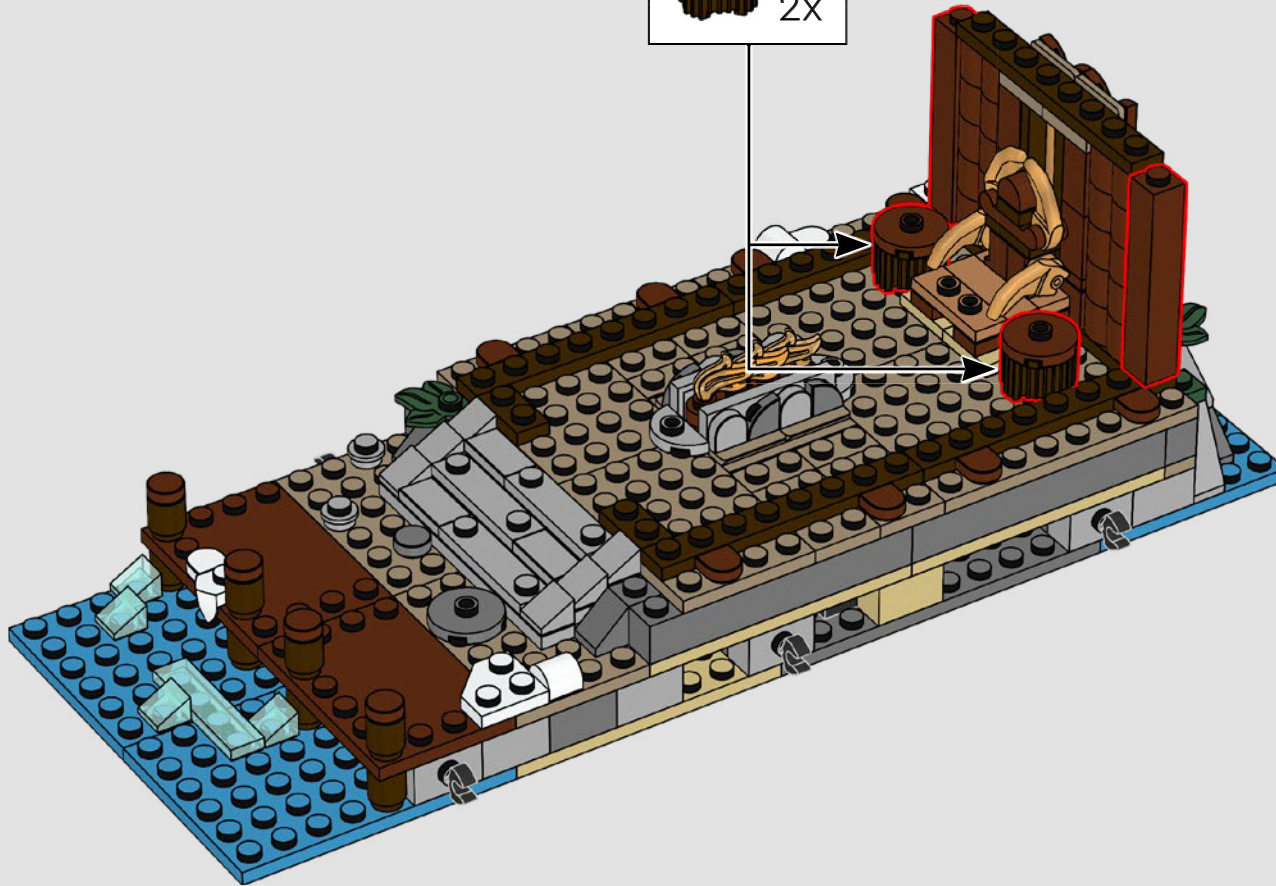
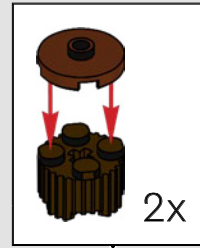

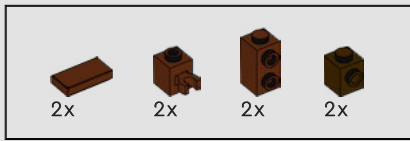

176



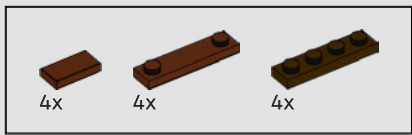

177

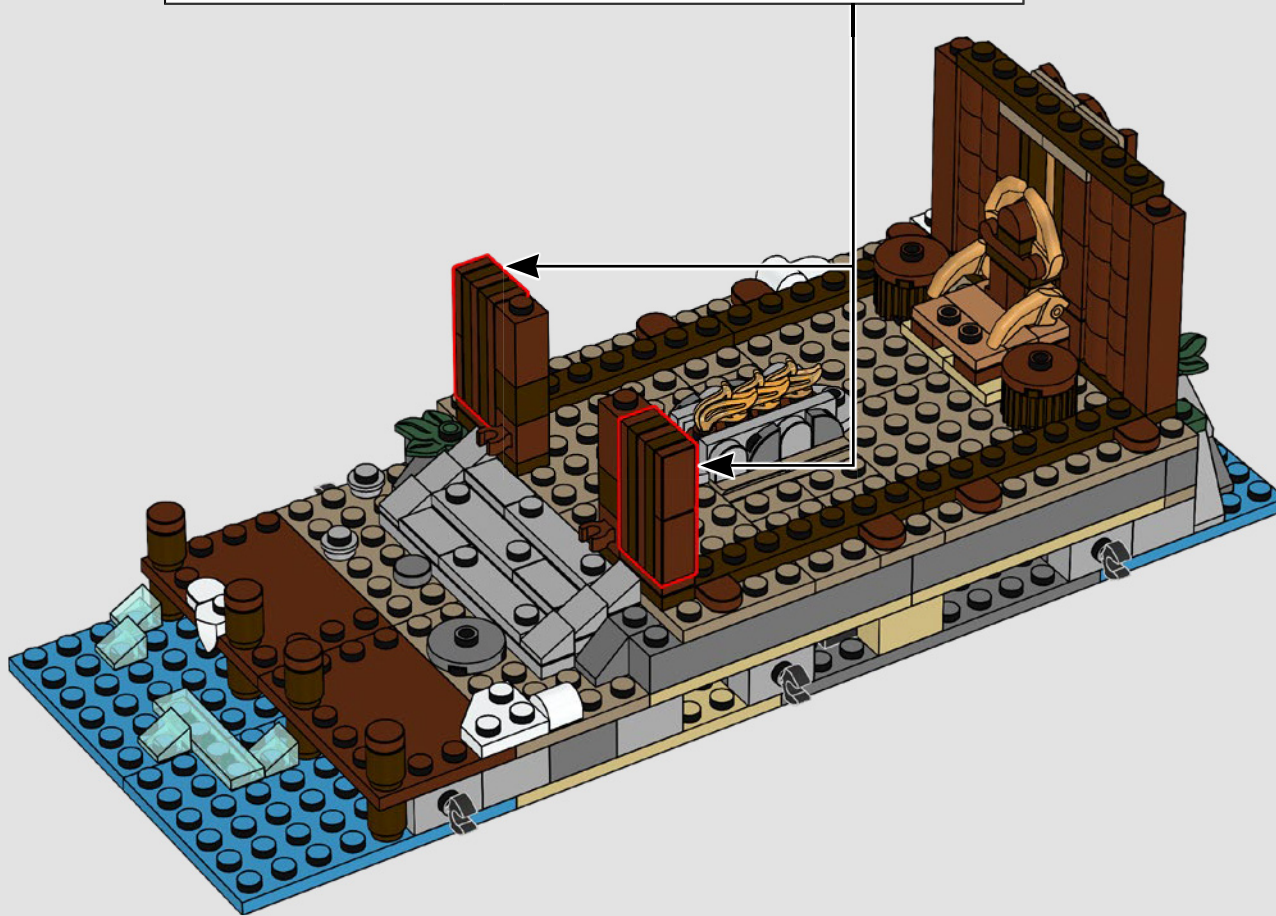
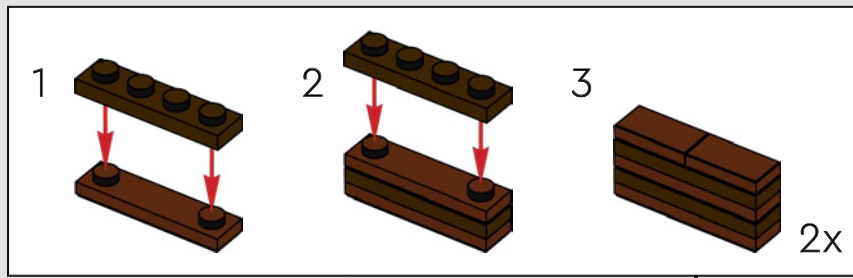

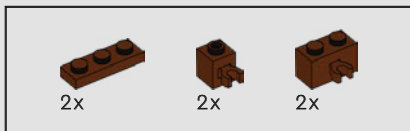

178

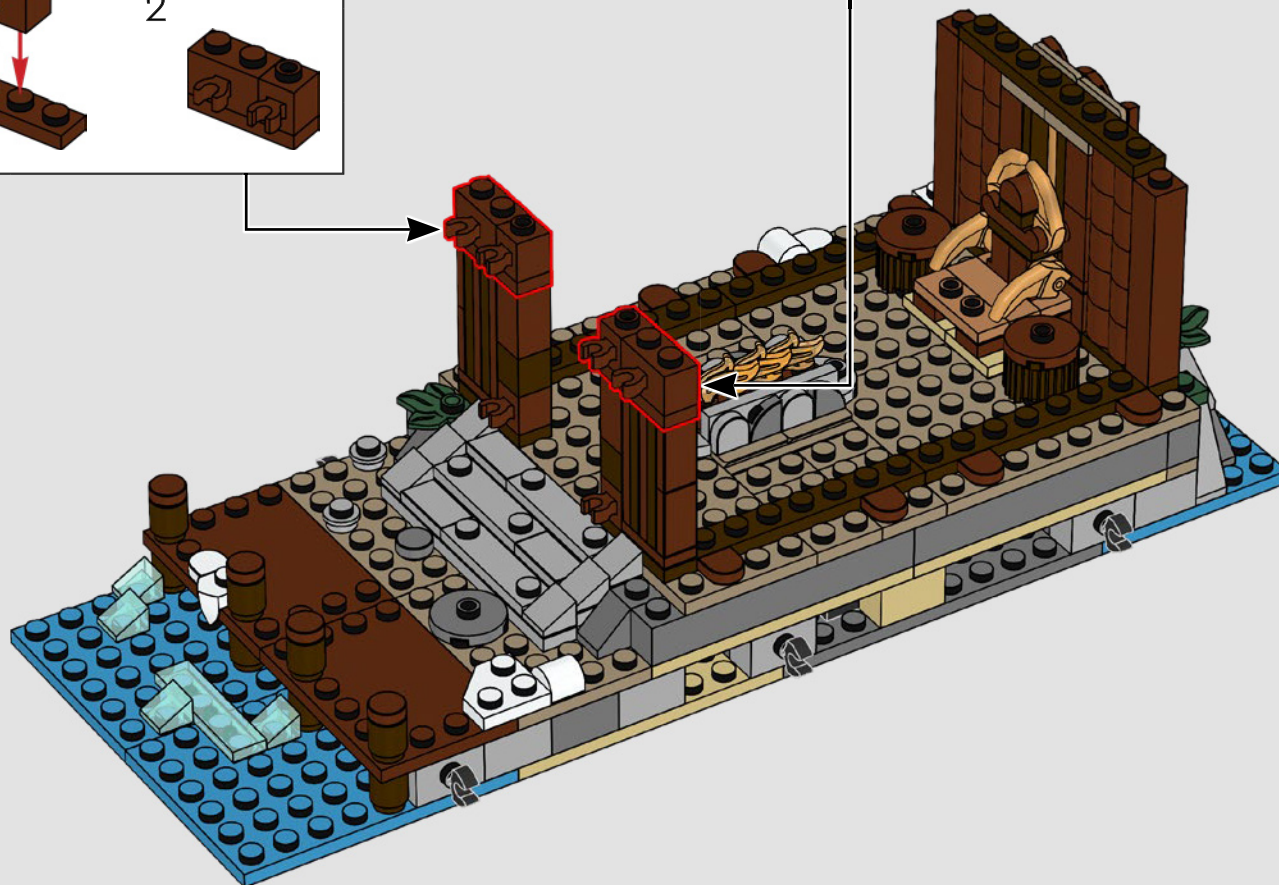
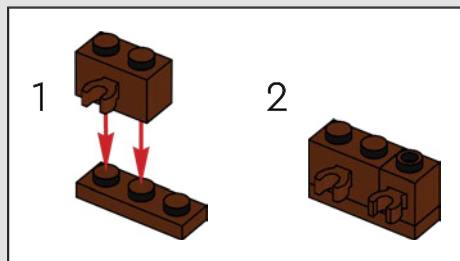
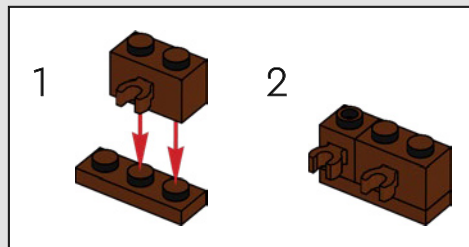

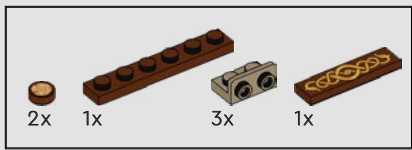

179

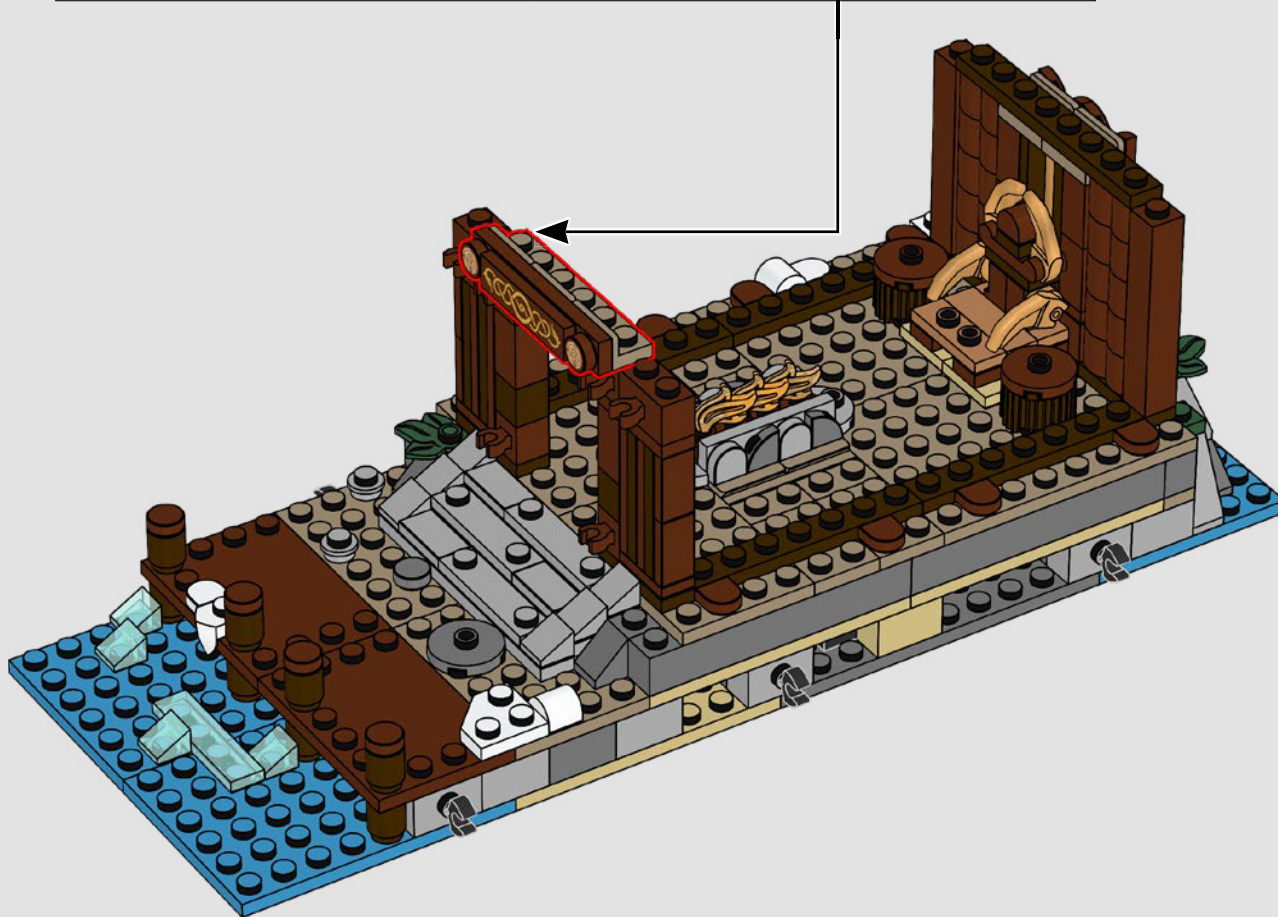
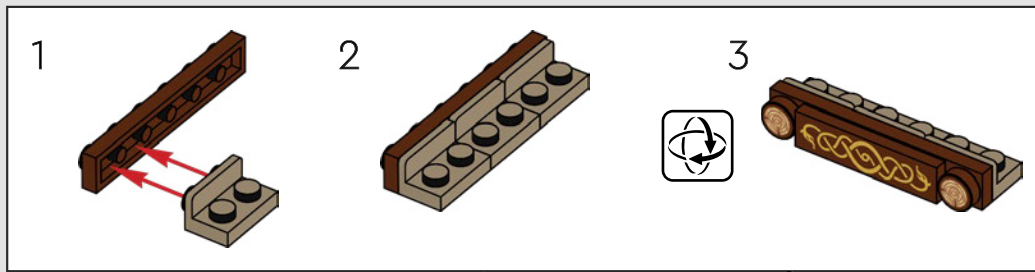



180

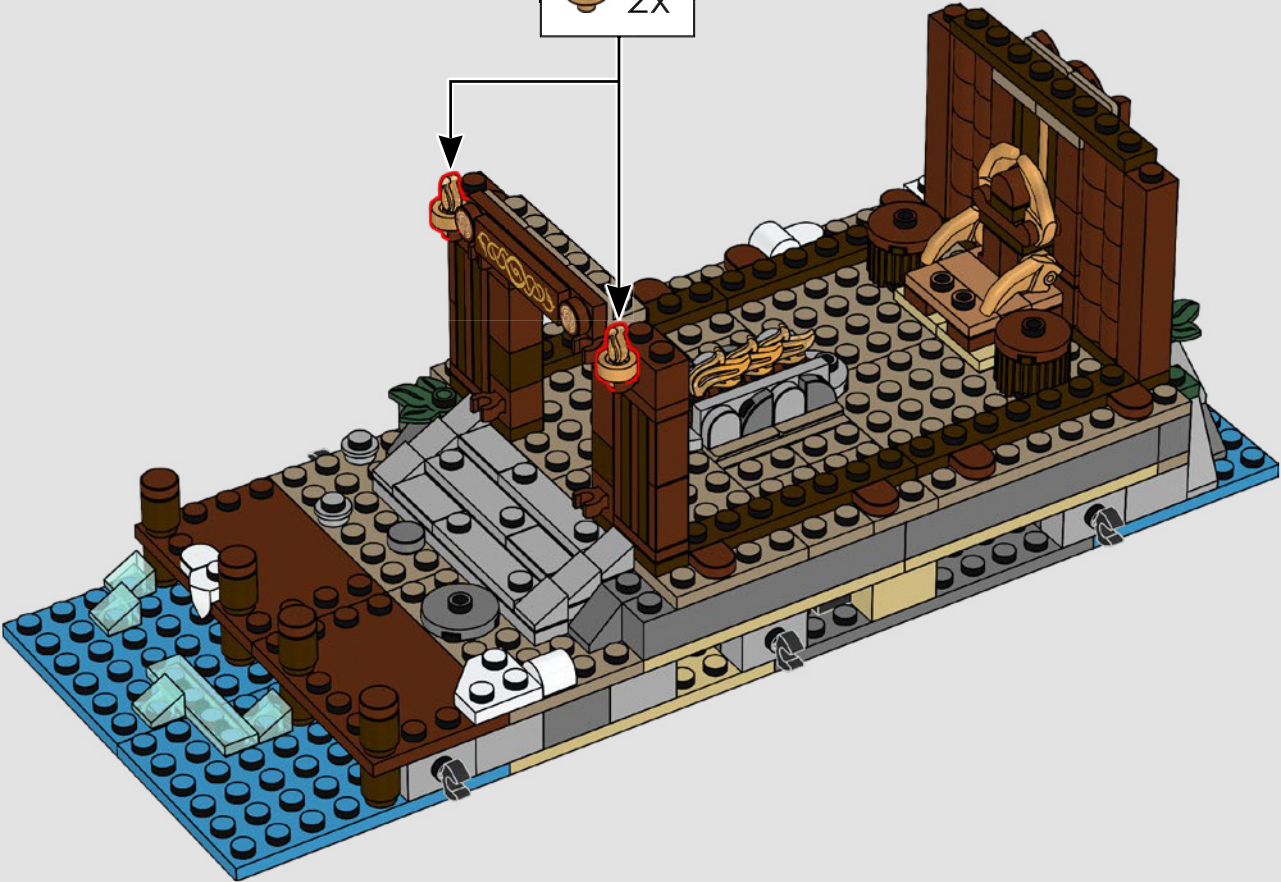
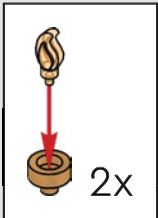



181

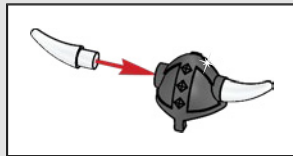
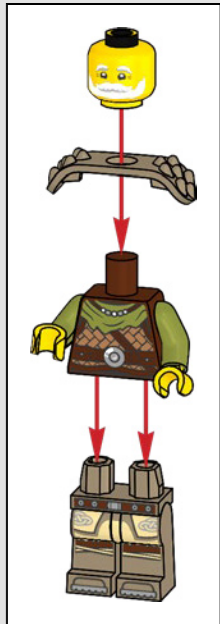
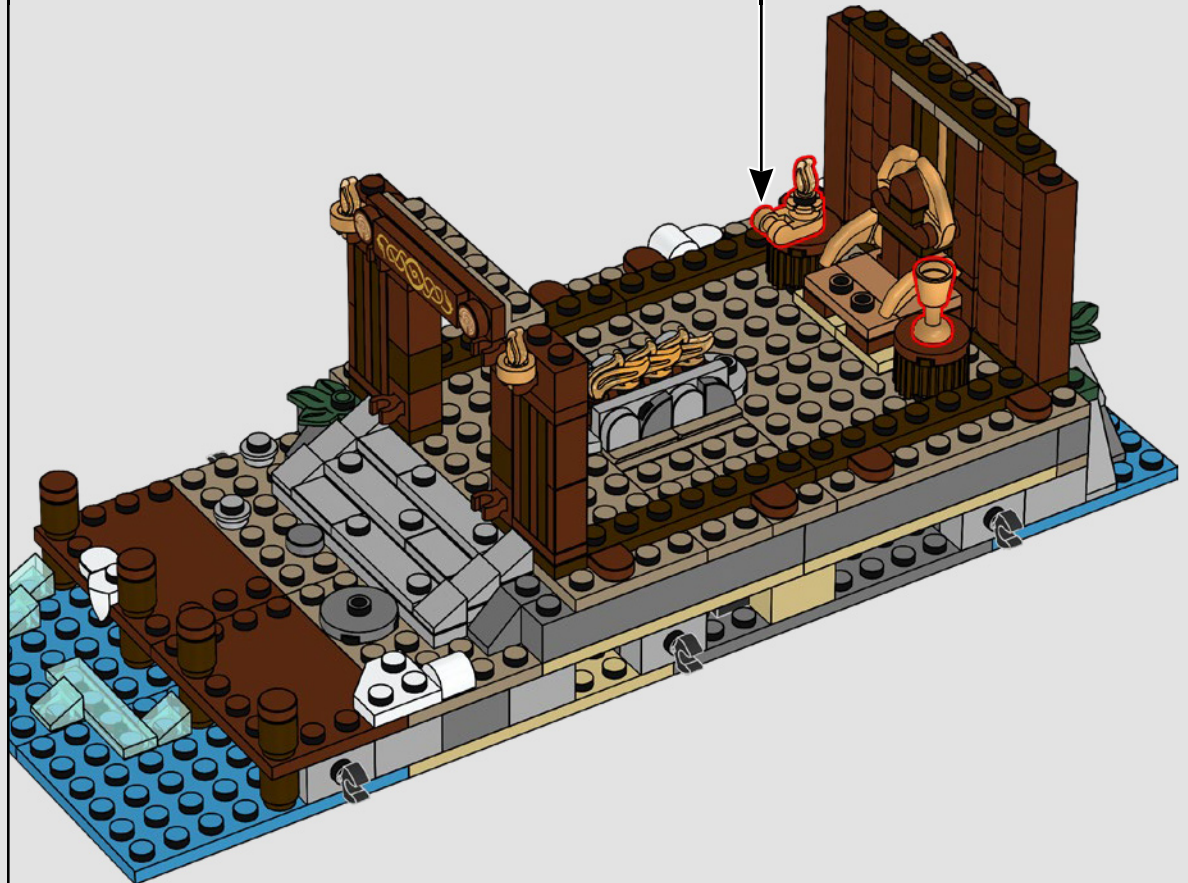
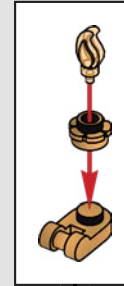



182

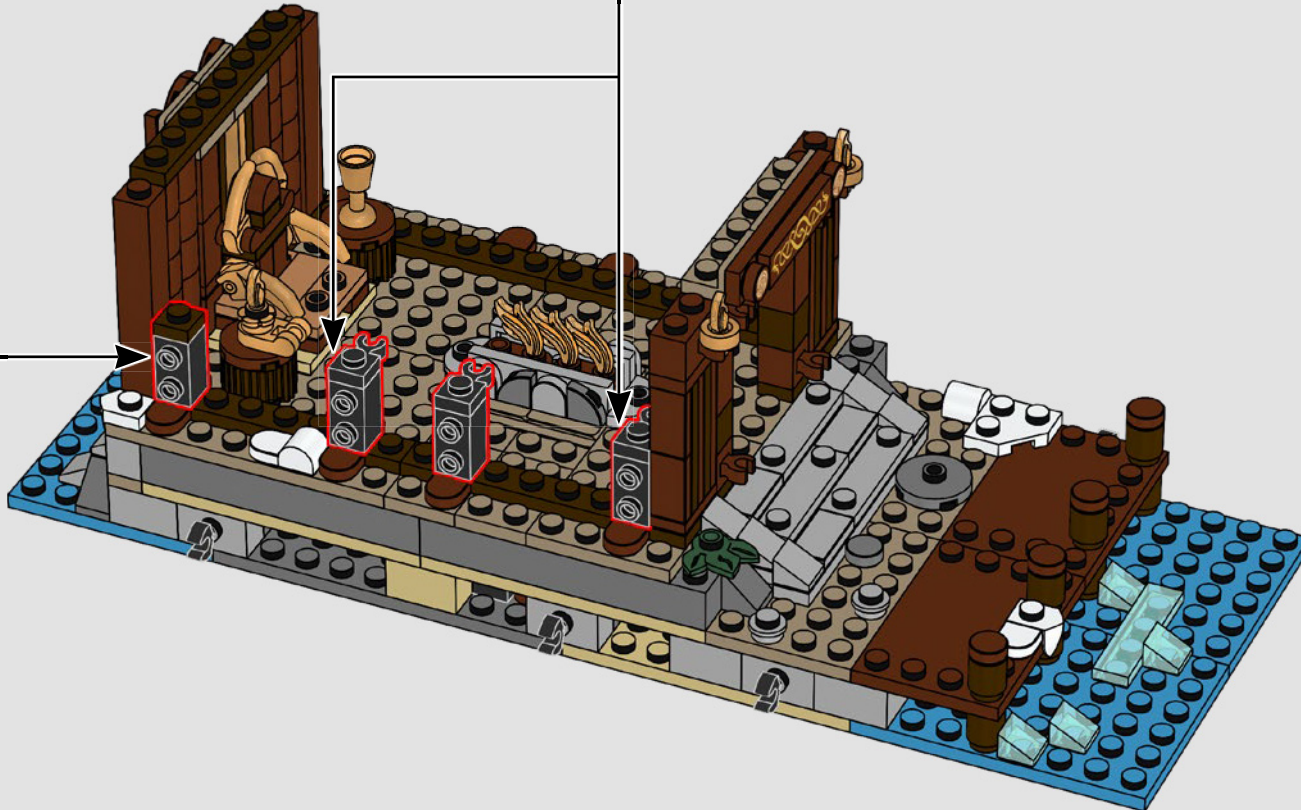
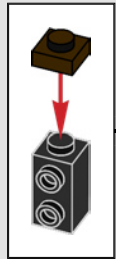
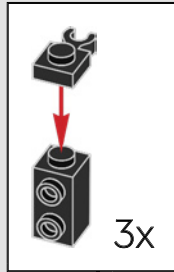

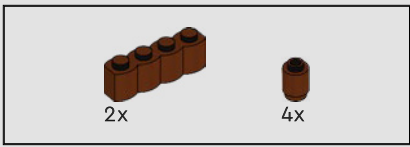

183

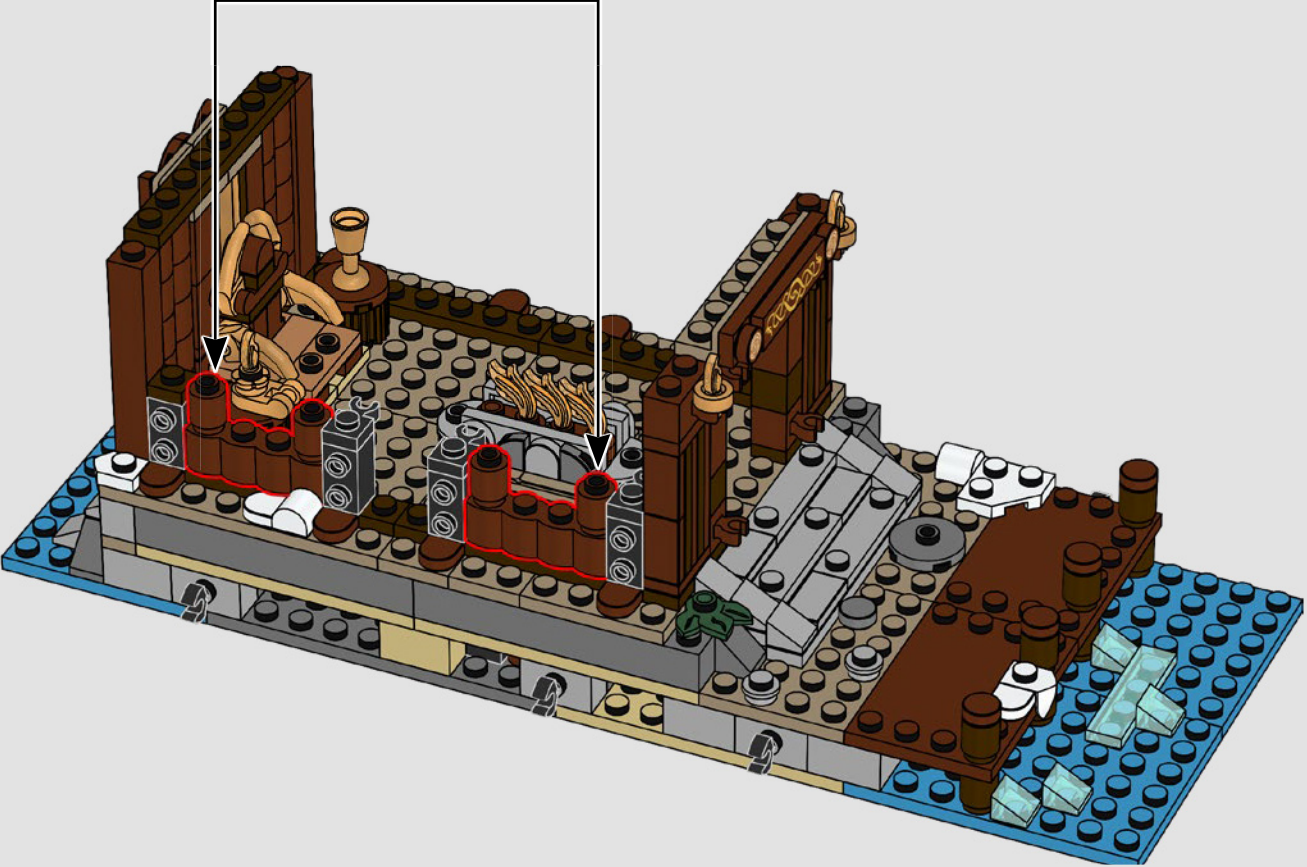
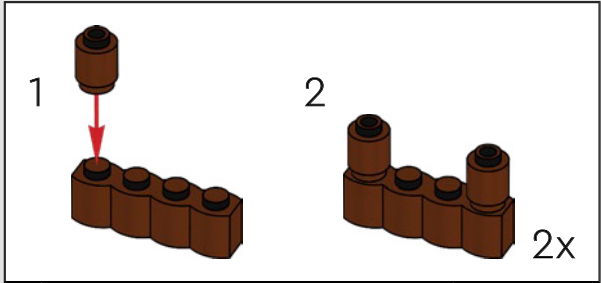

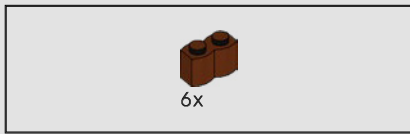

184

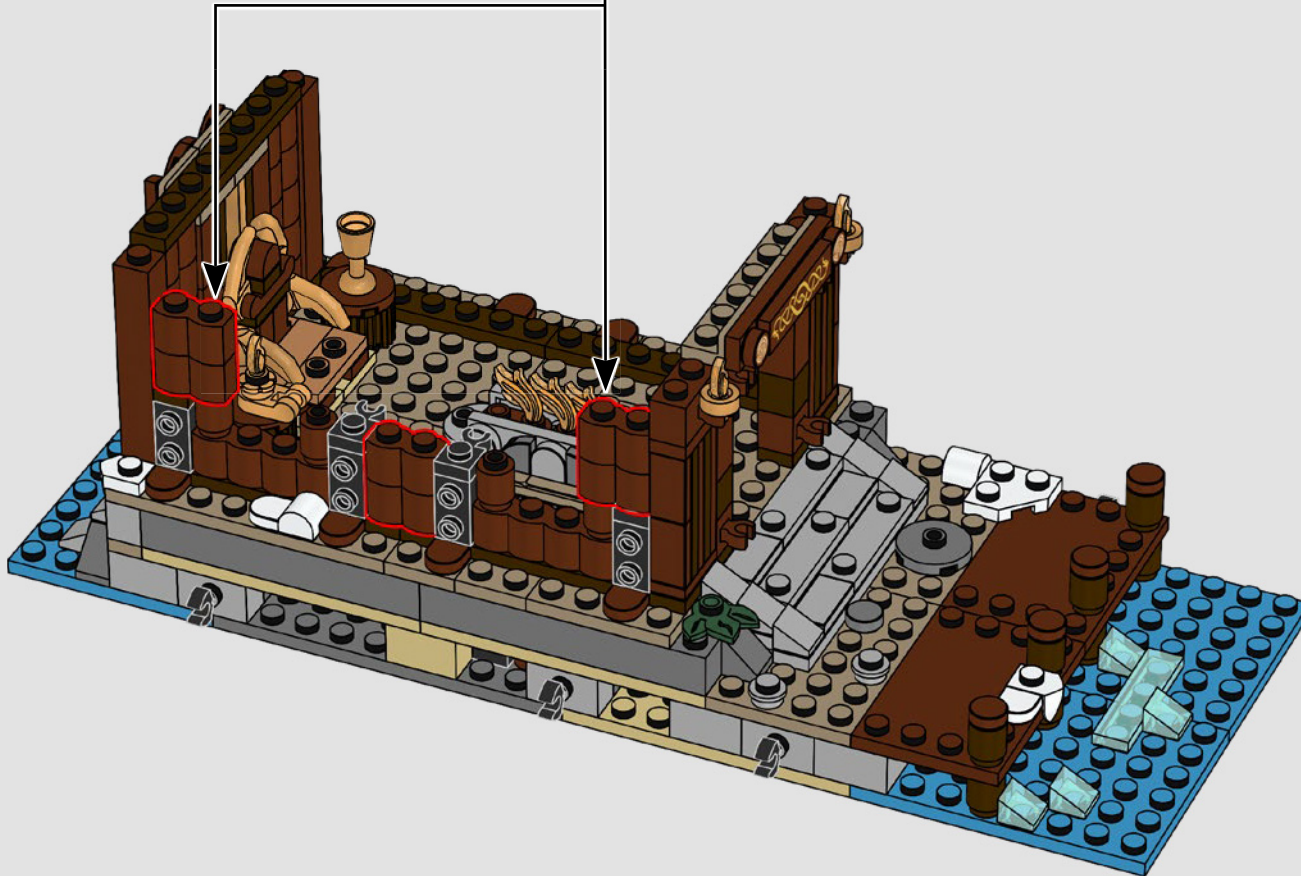
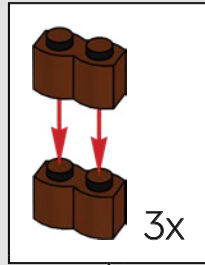

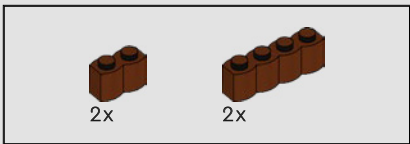

185

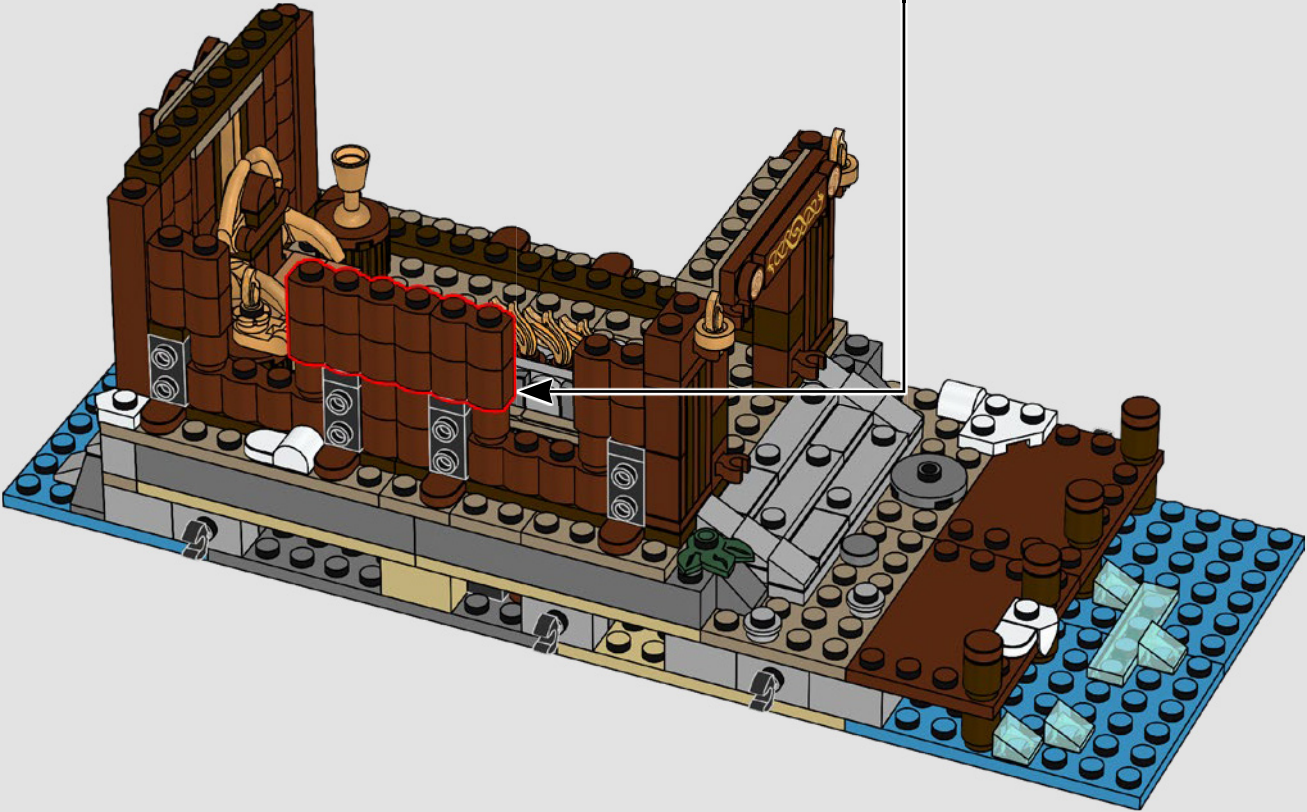
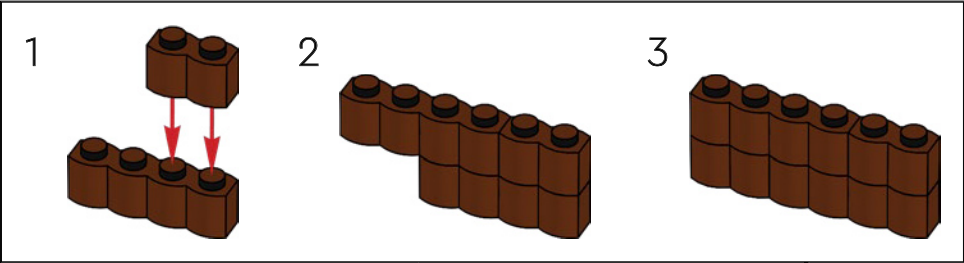

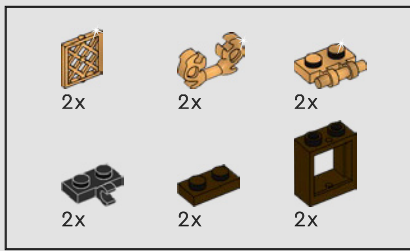

186

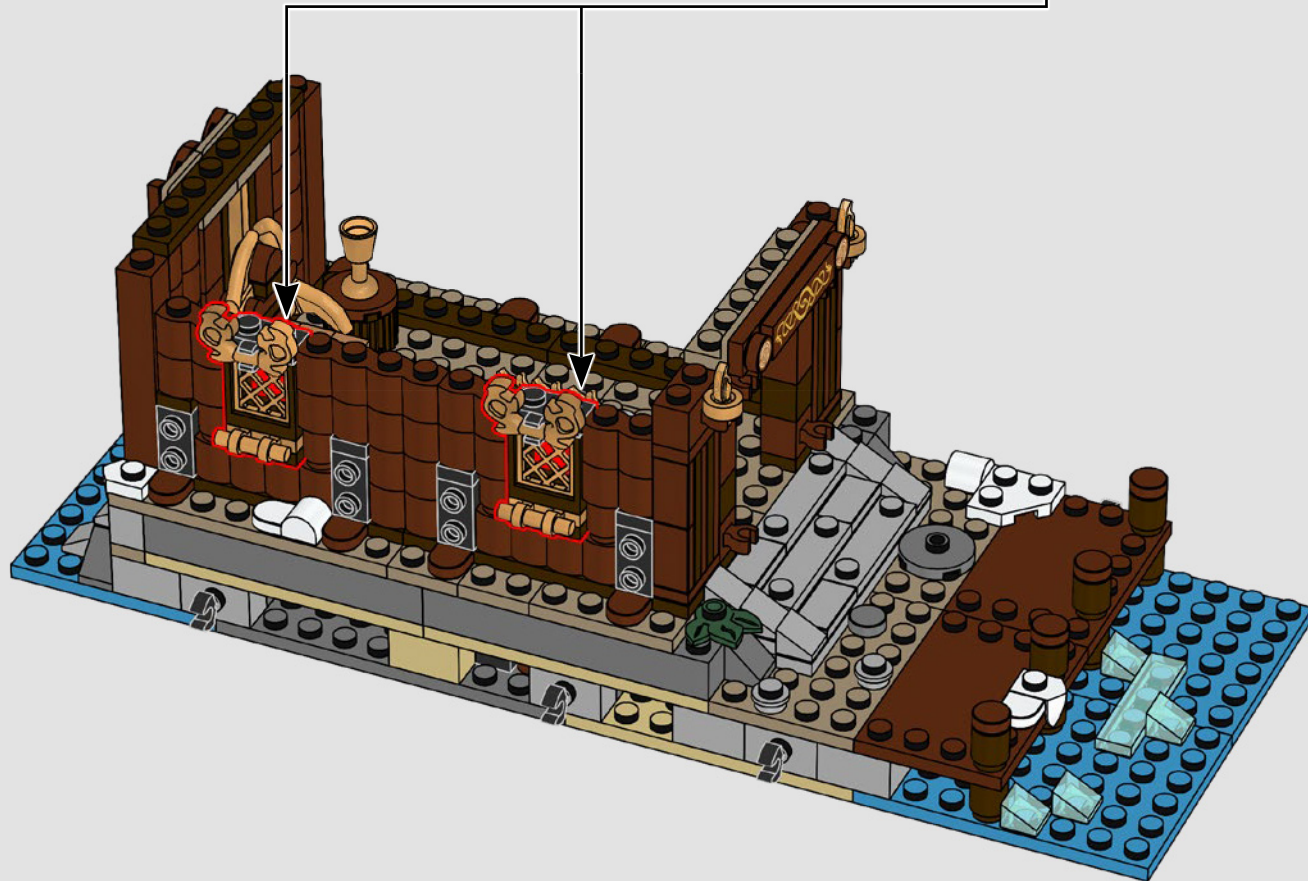
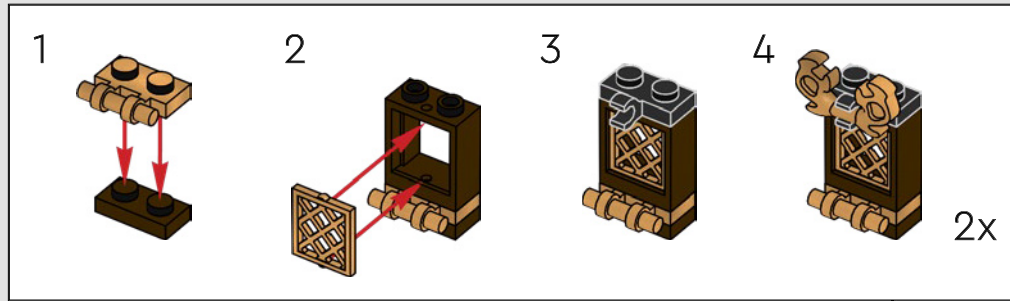

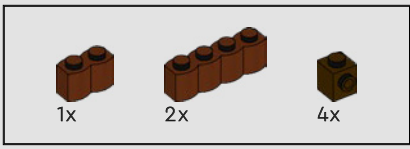

187



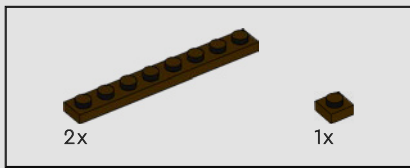

188

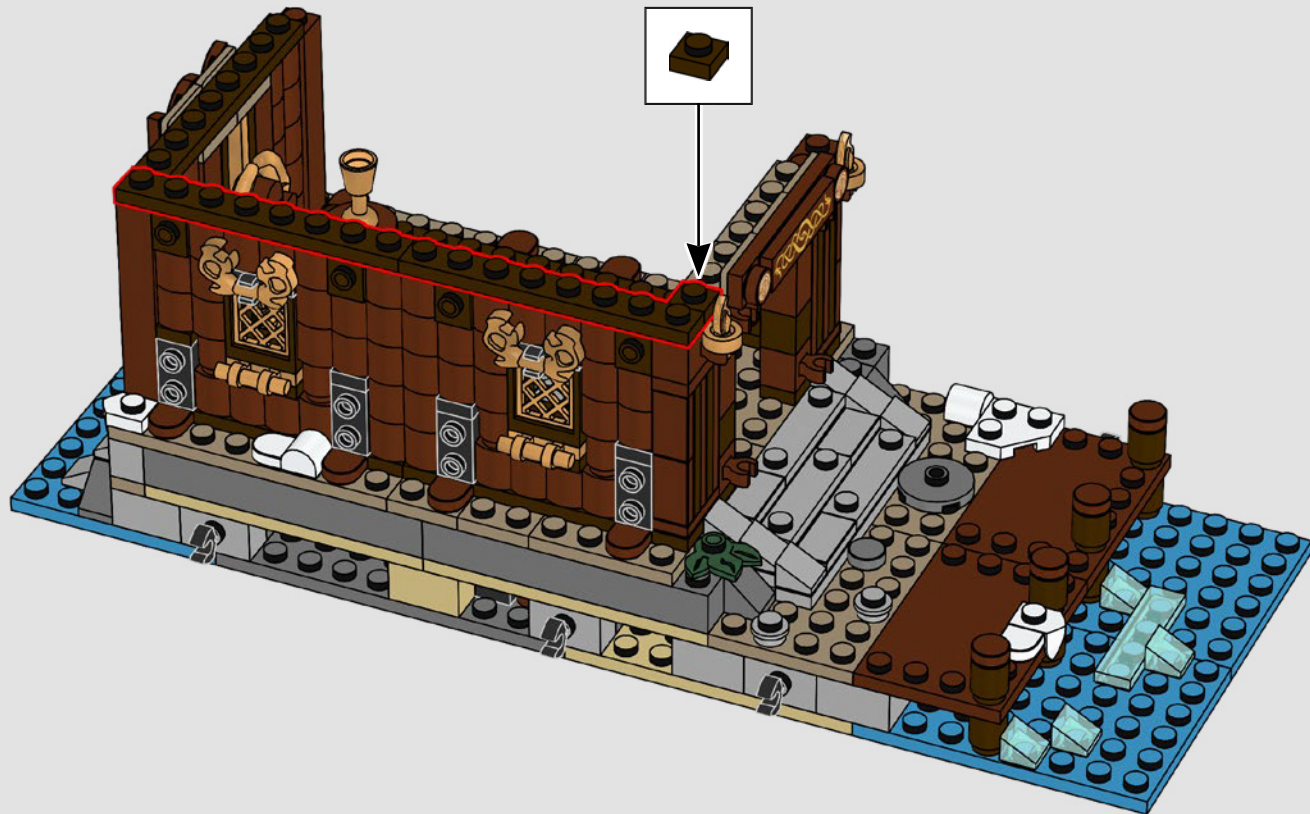



190

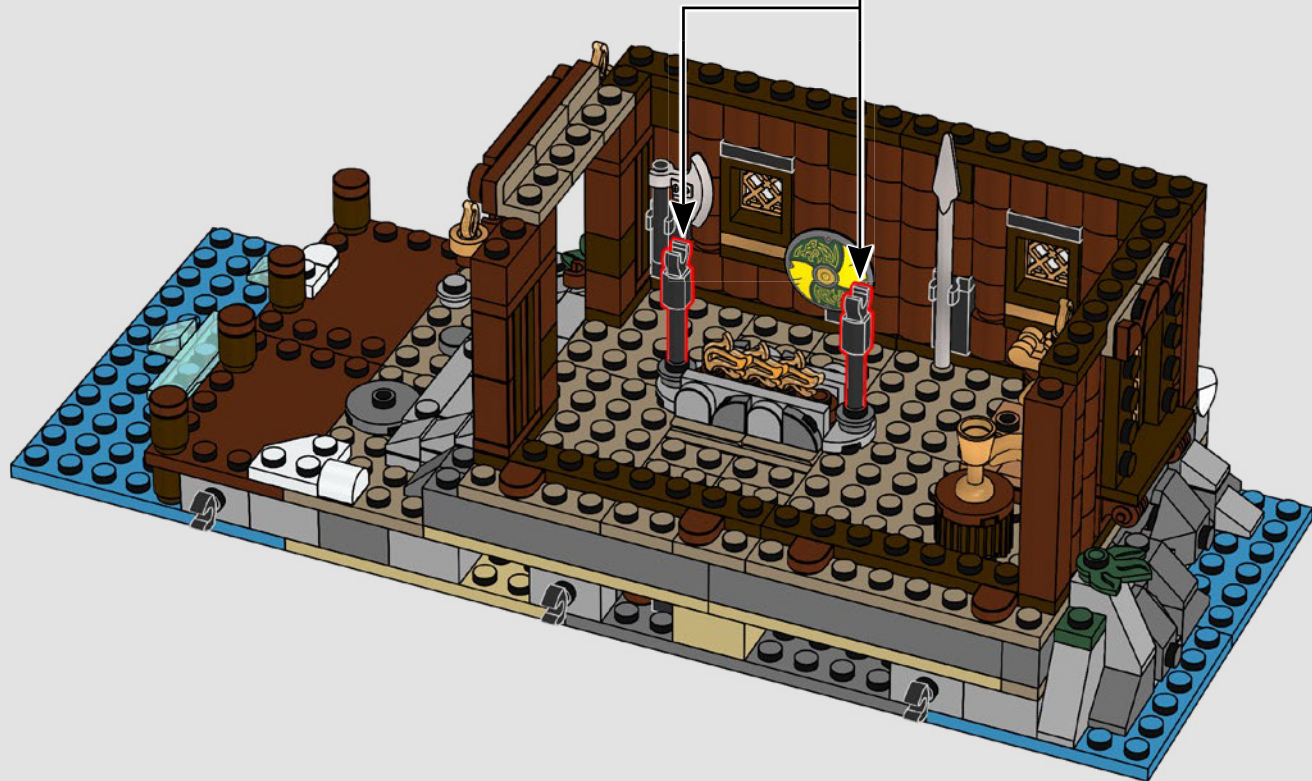
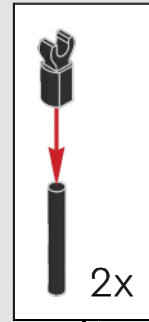

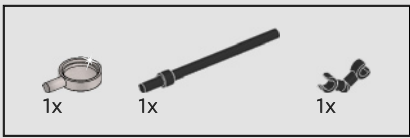

191

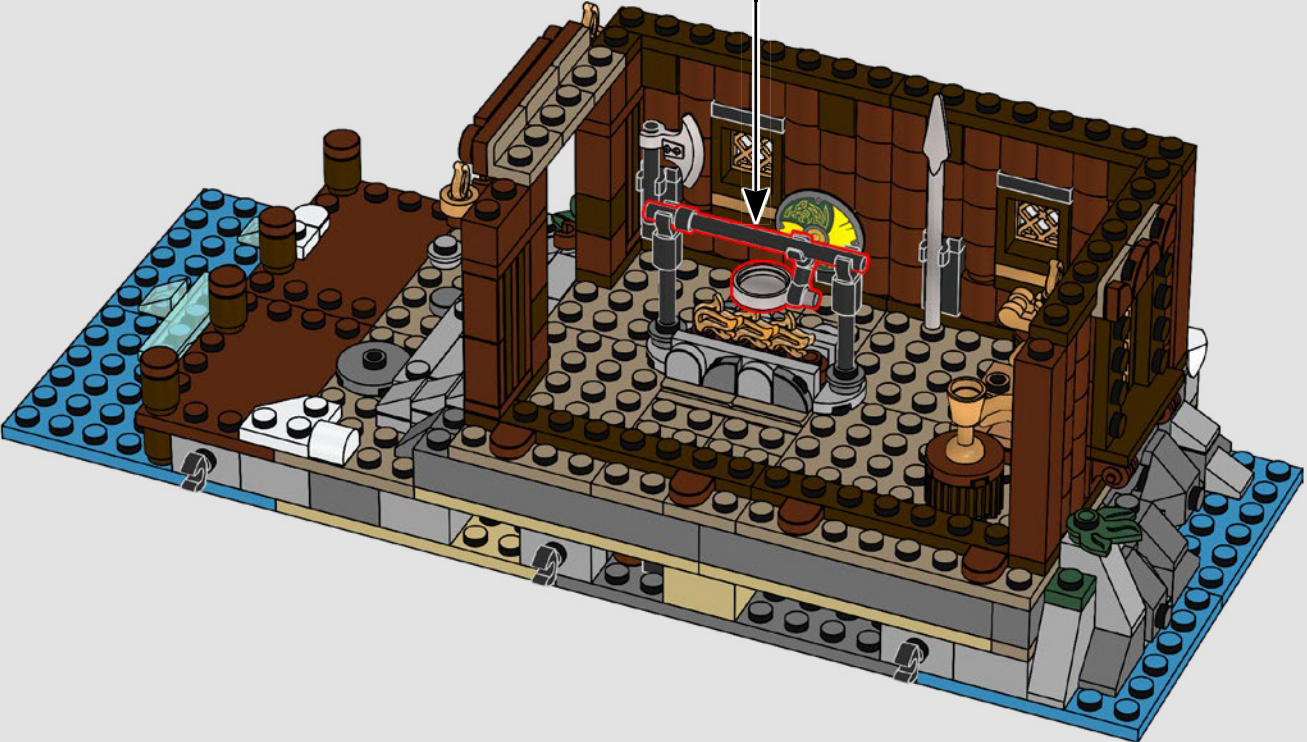
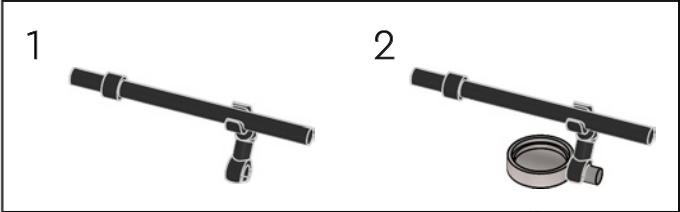

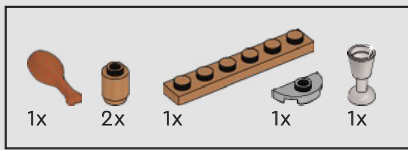

192

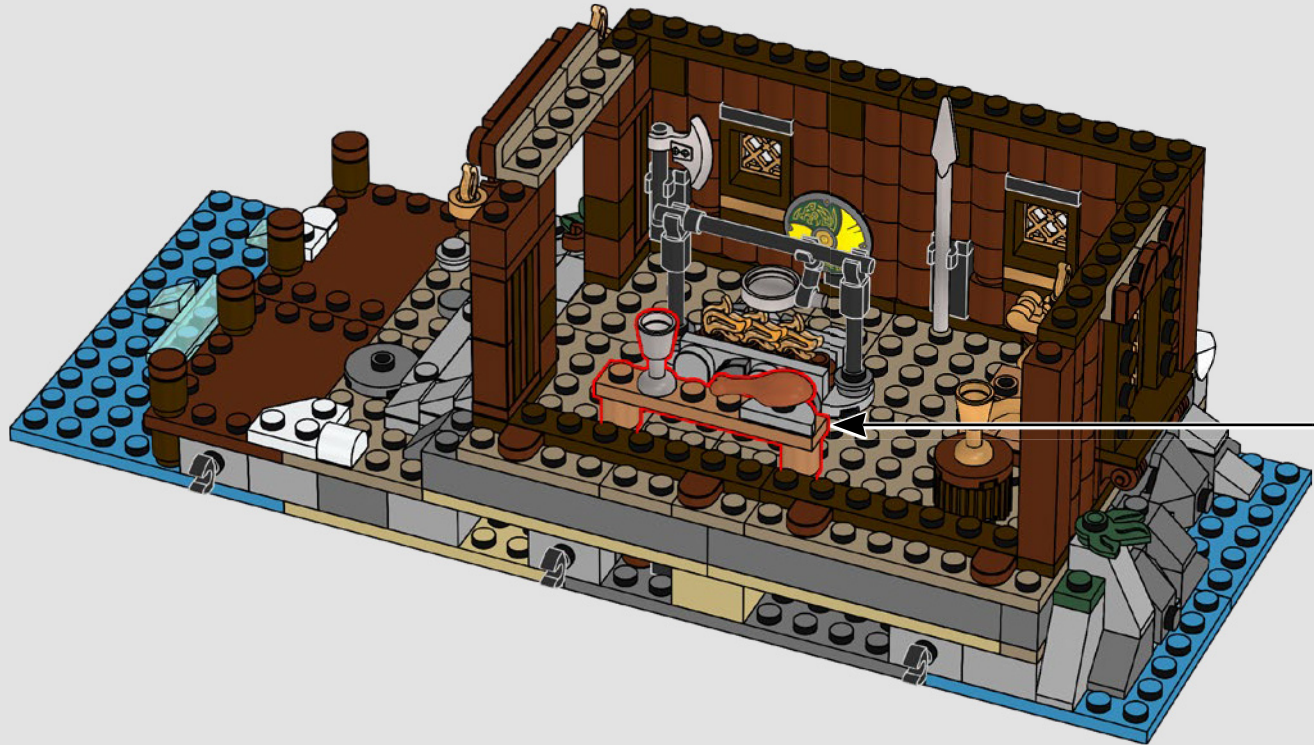
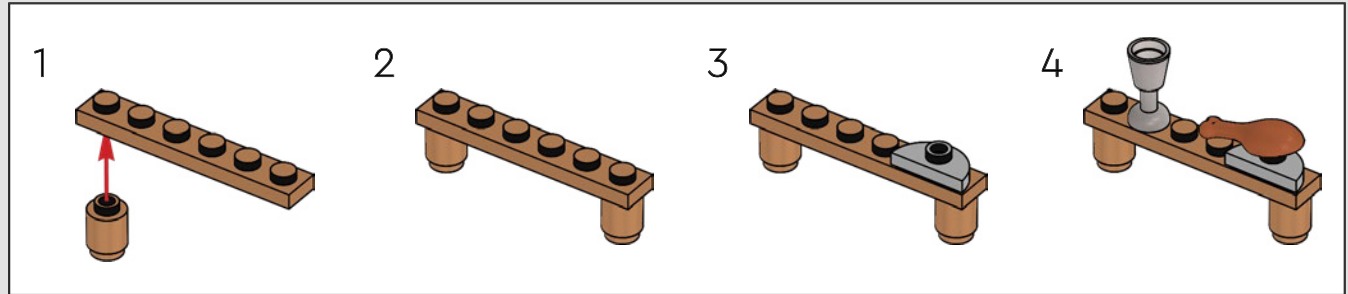

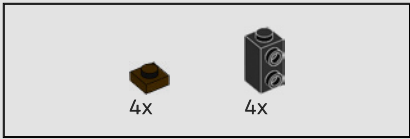

193

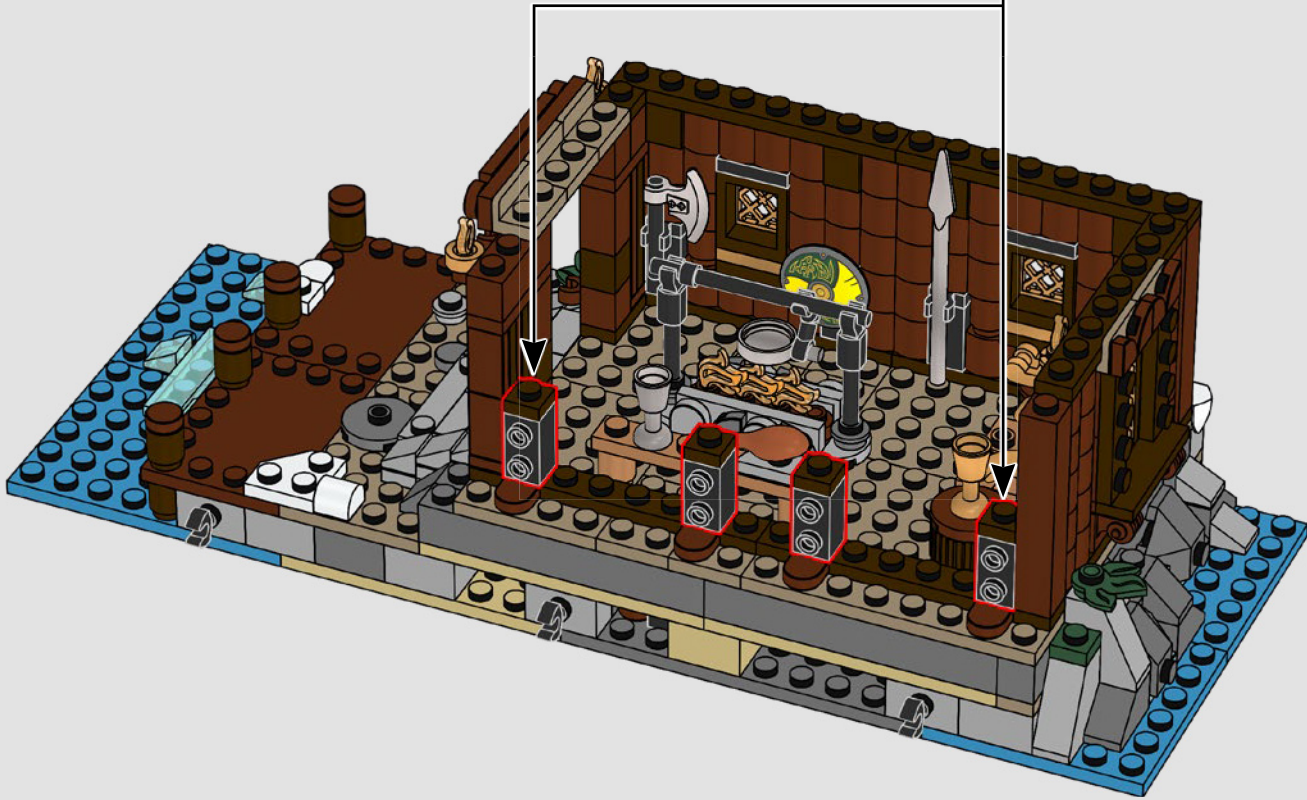
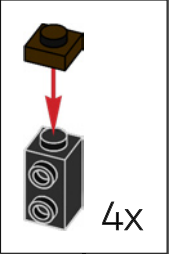

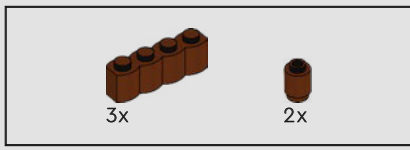

194

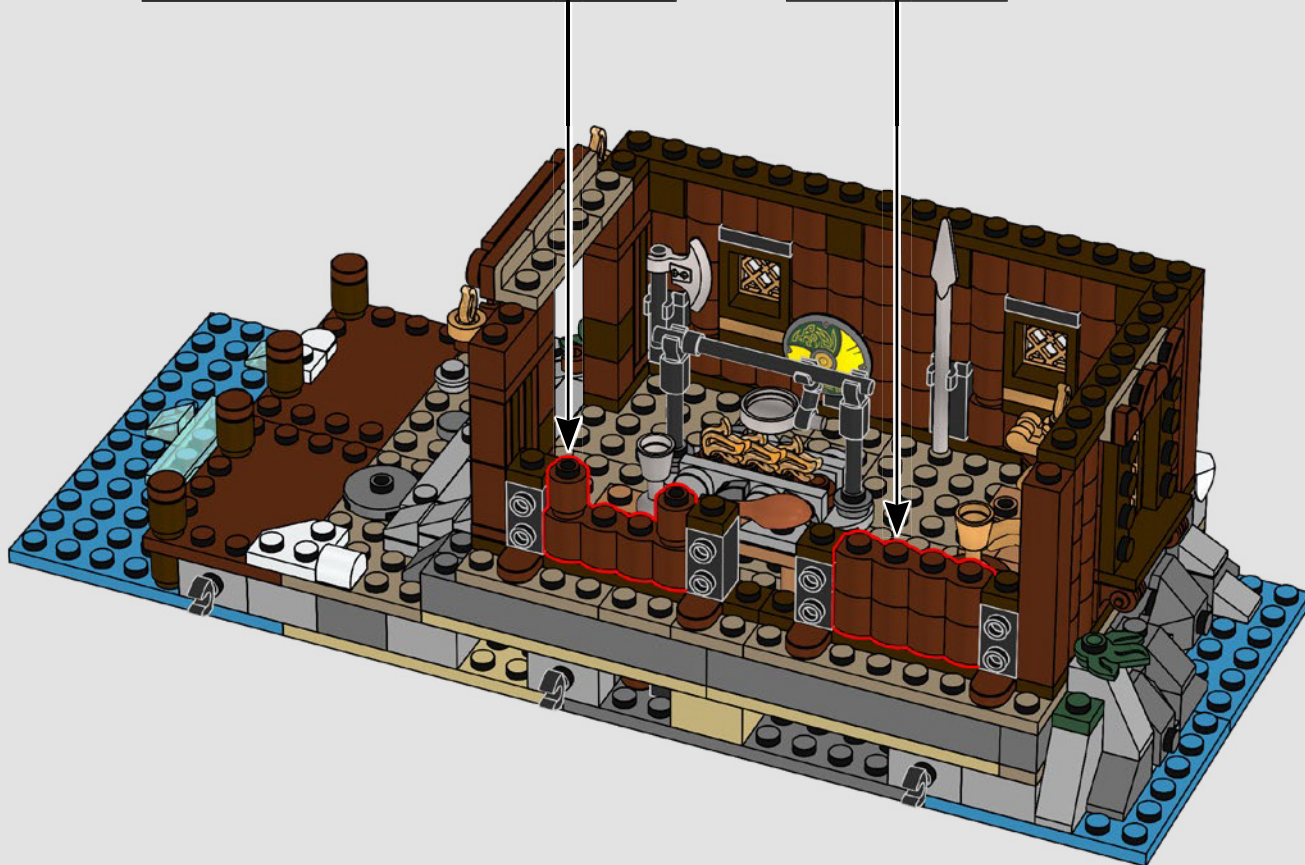
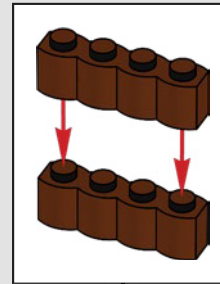
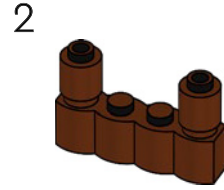
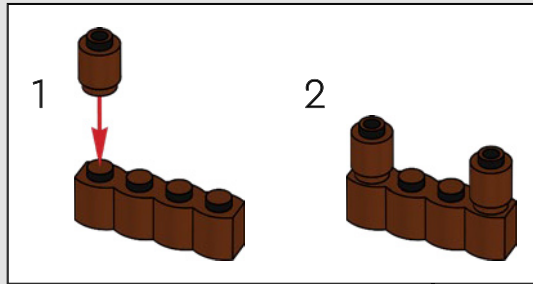



4x

195



2x

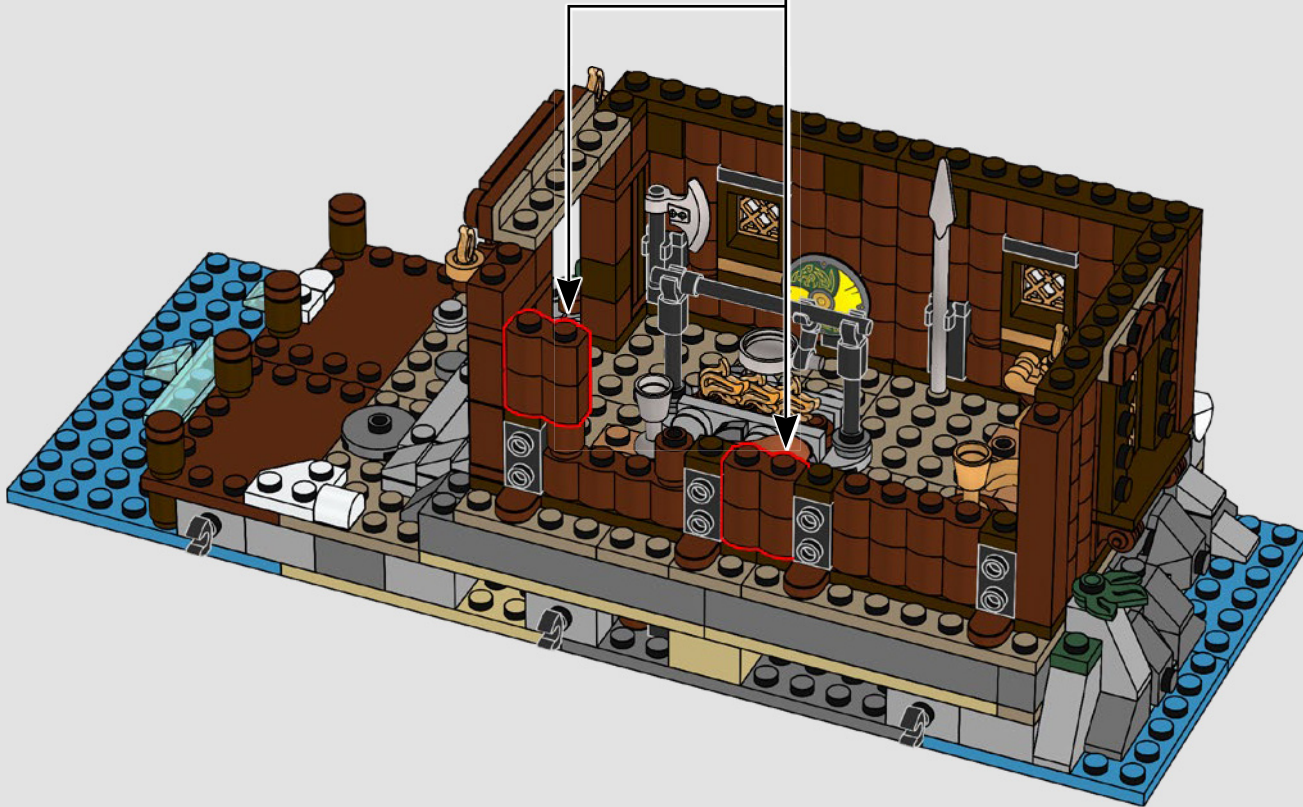

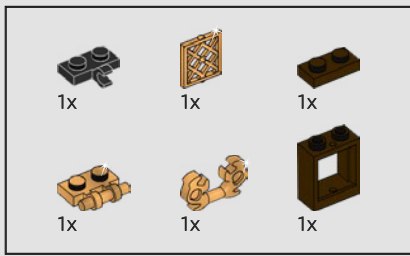

196

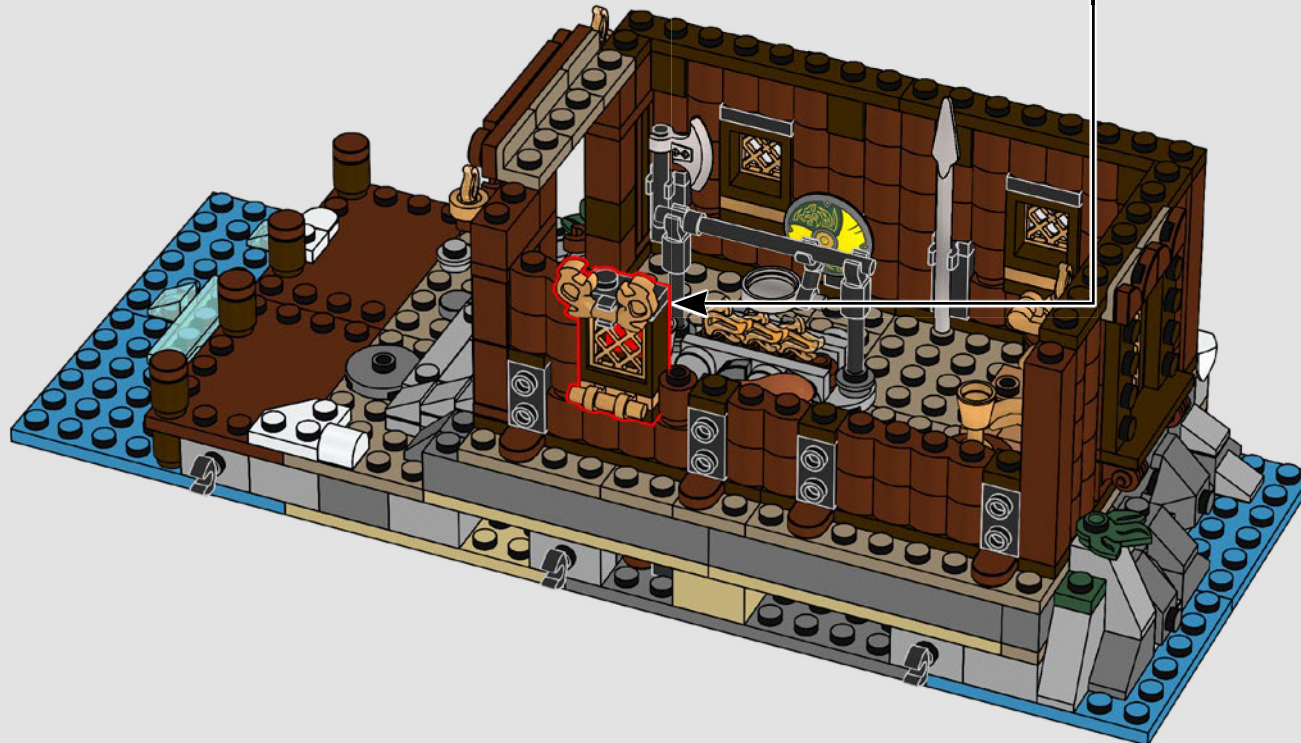
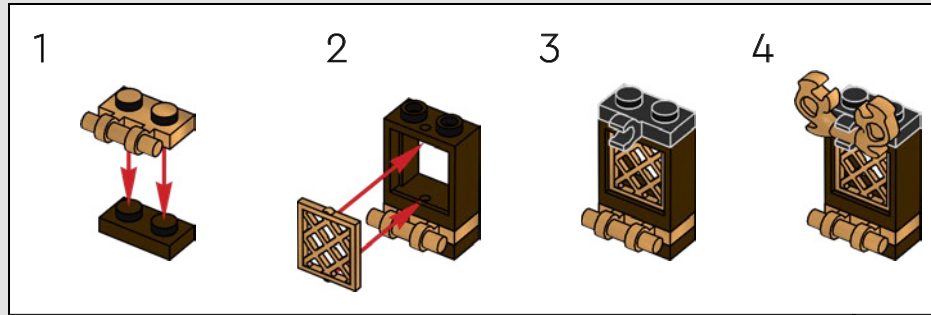

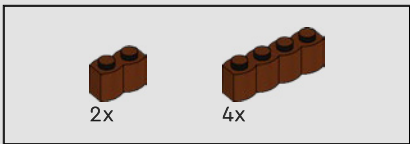

197

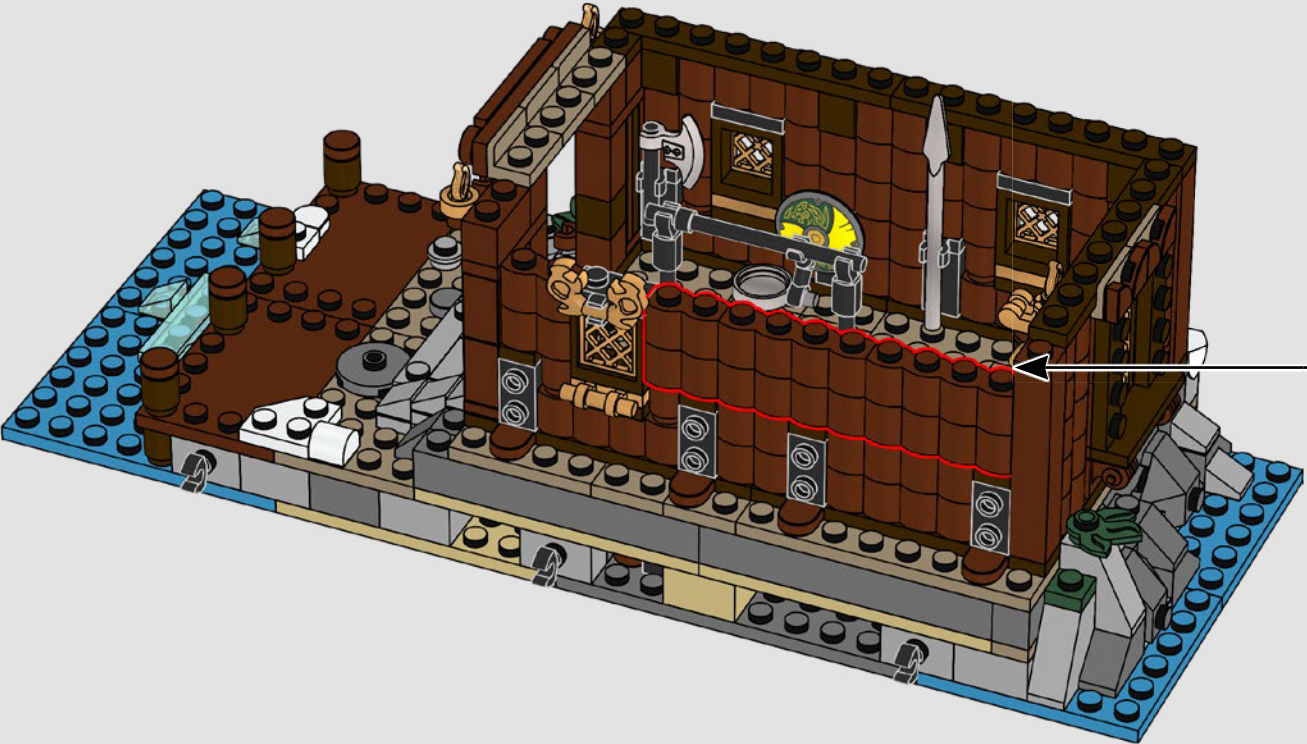
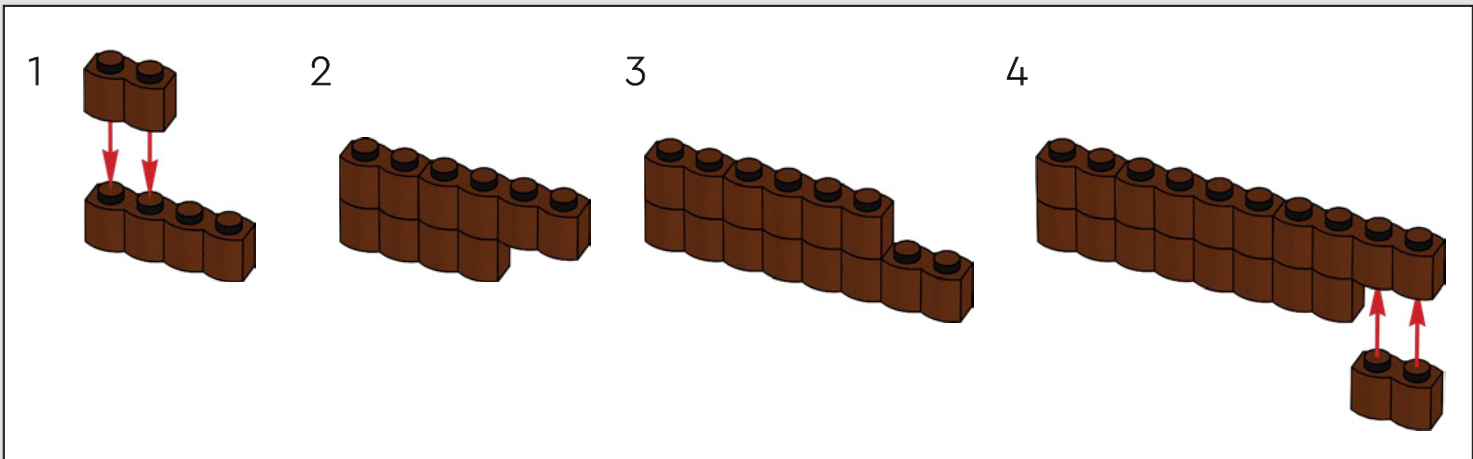

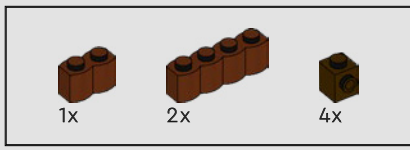

198

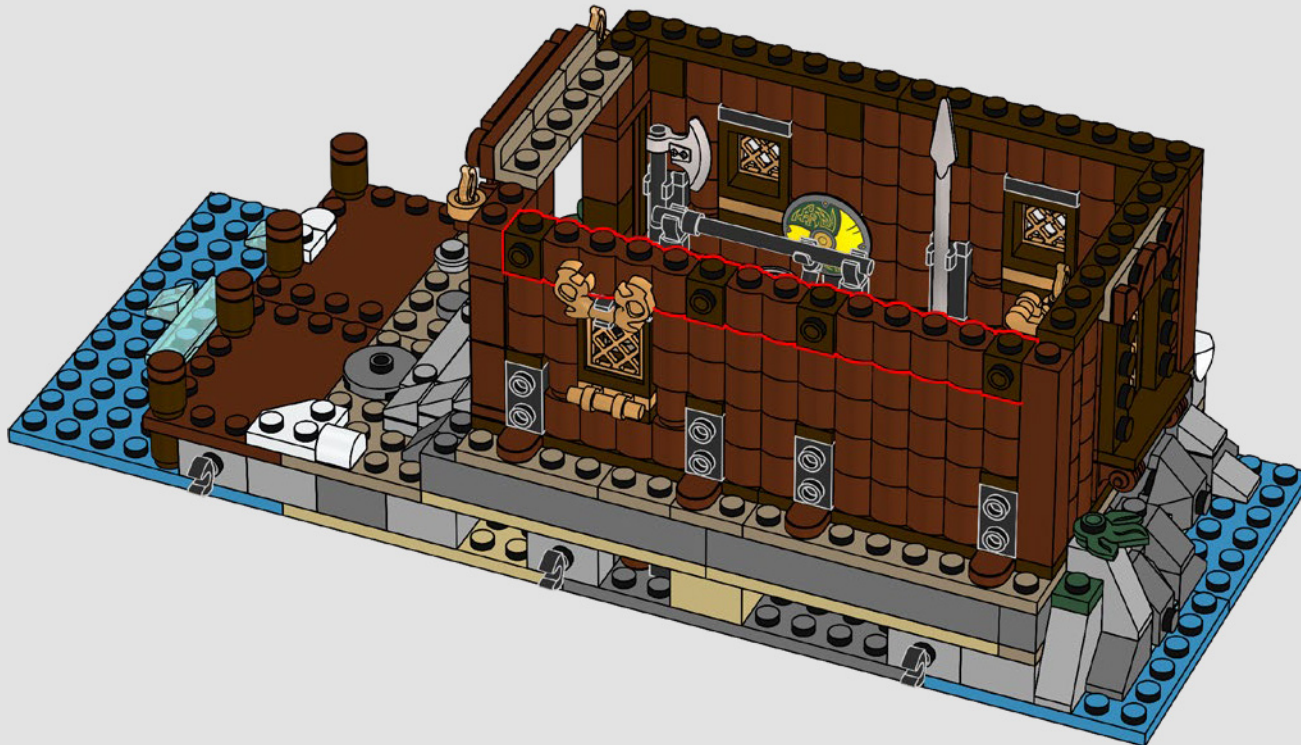

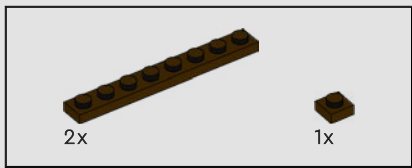

199

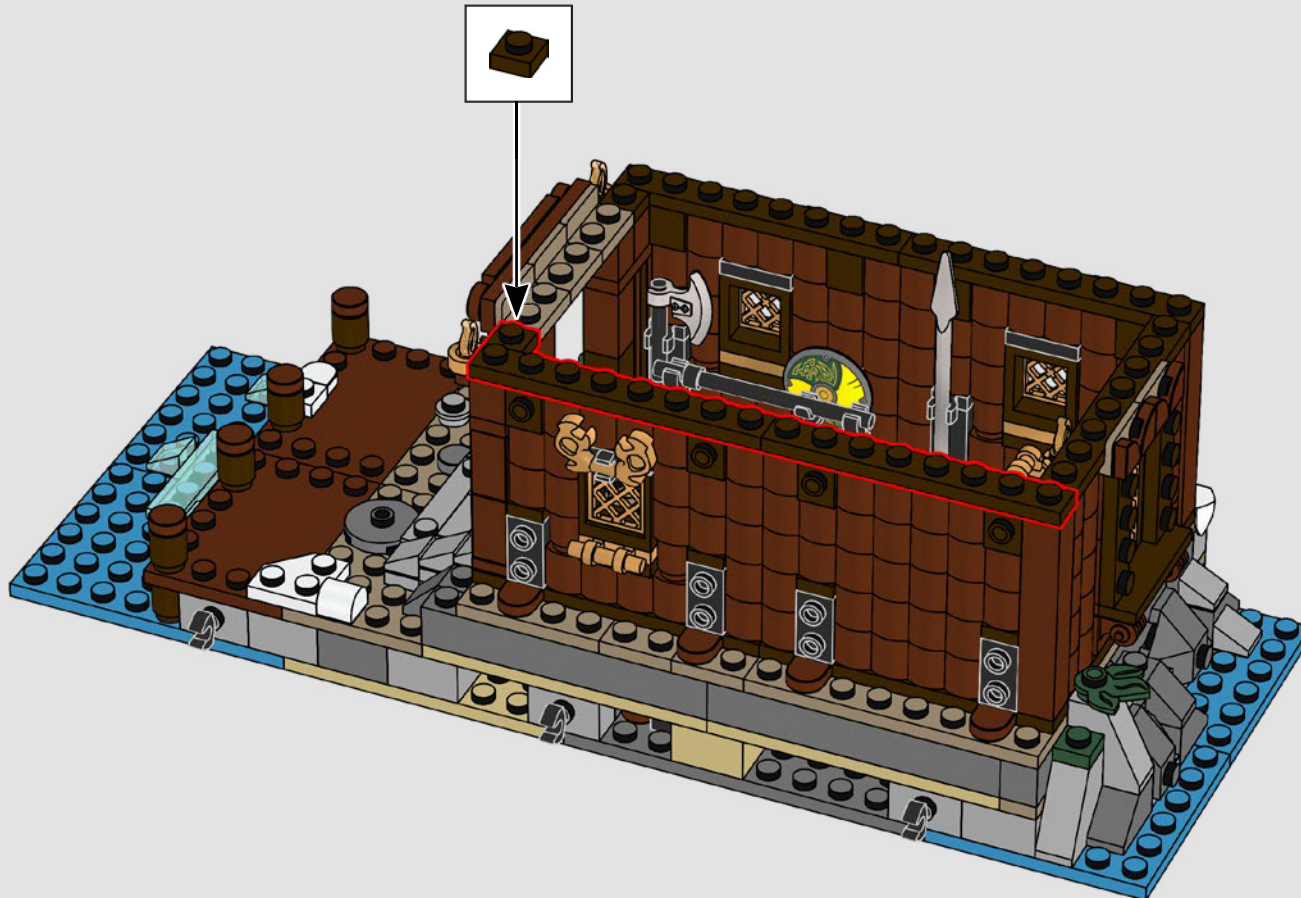

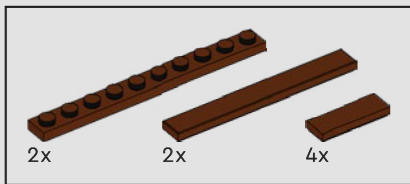

200

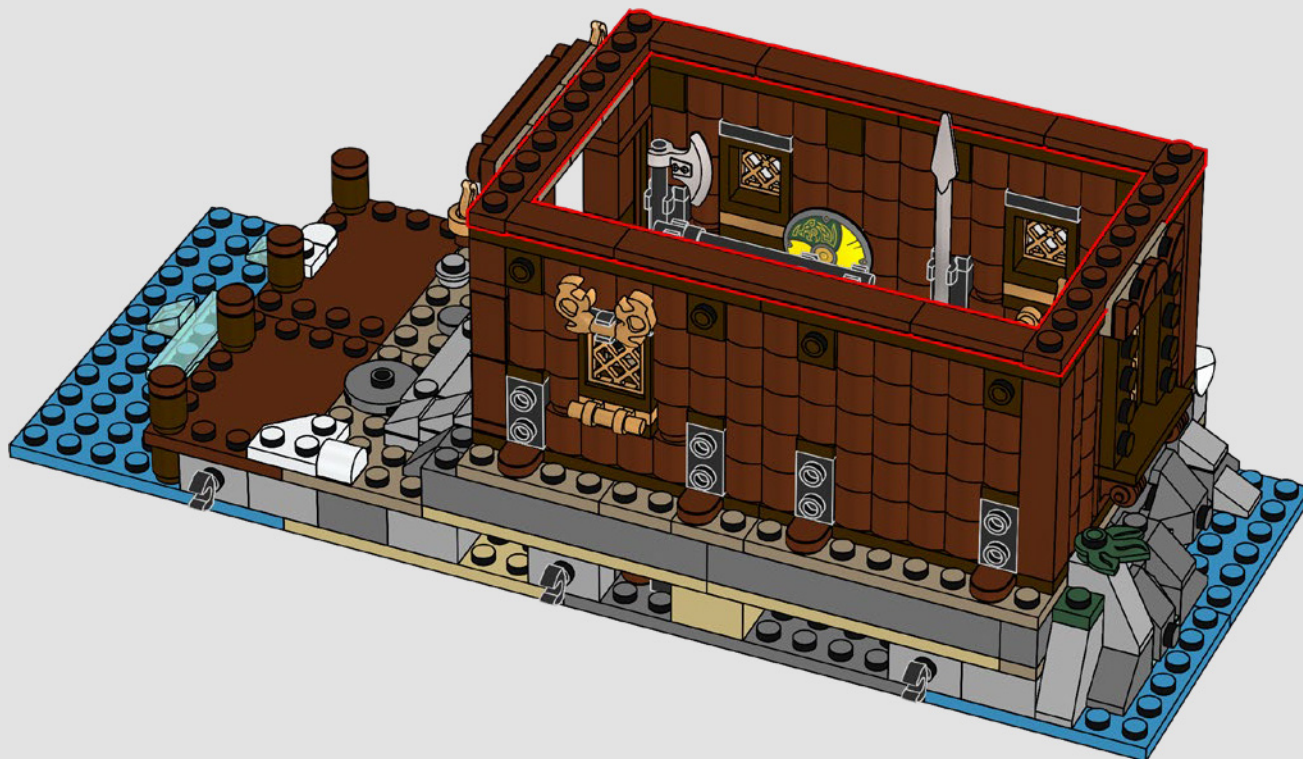

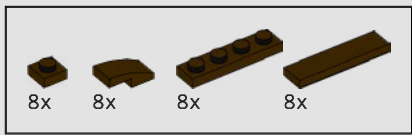

201

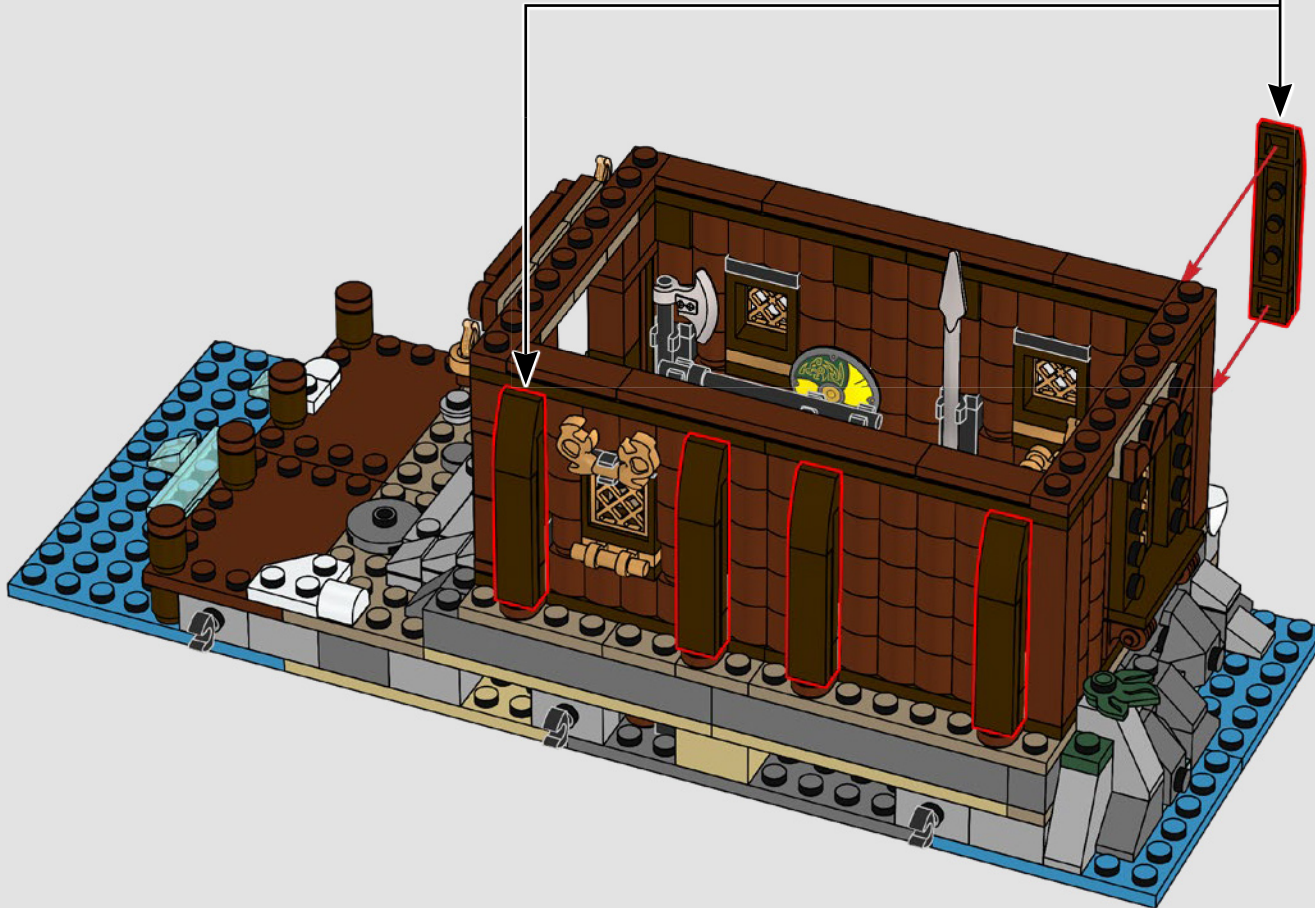
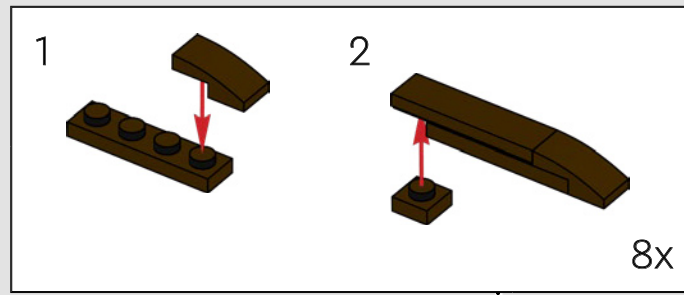



202

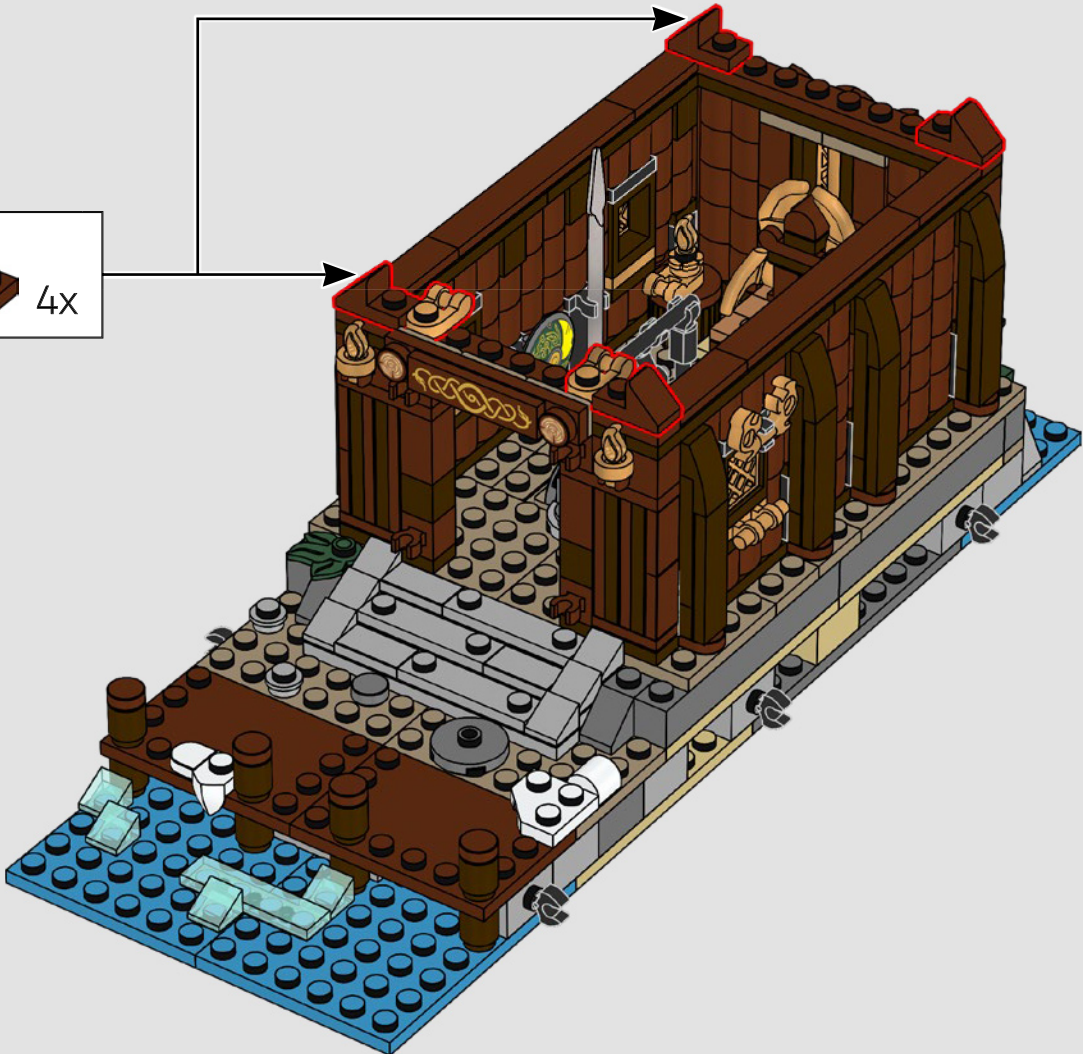
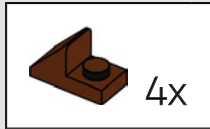

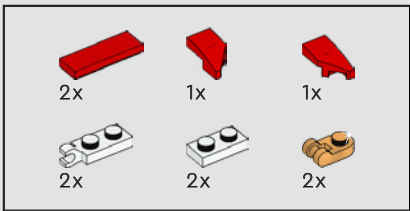

203

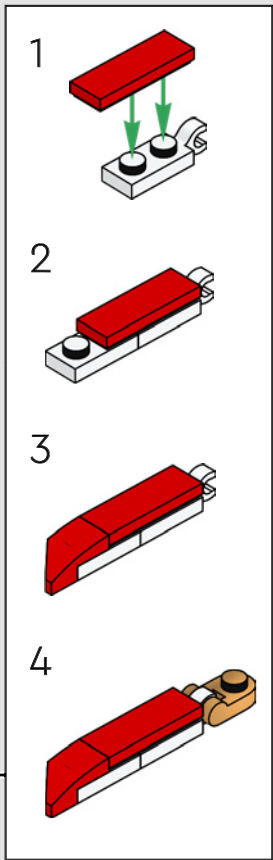
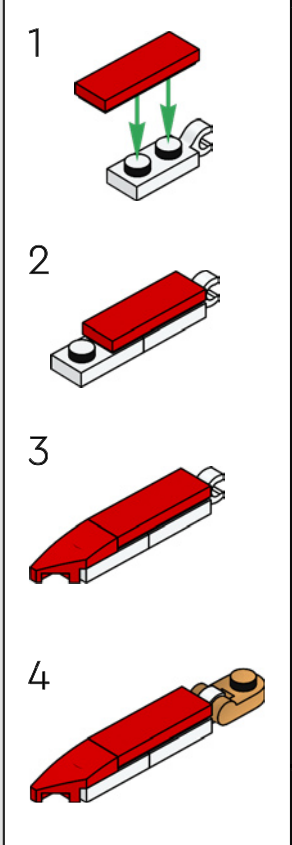

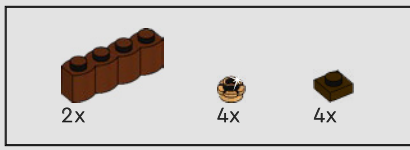

204





205

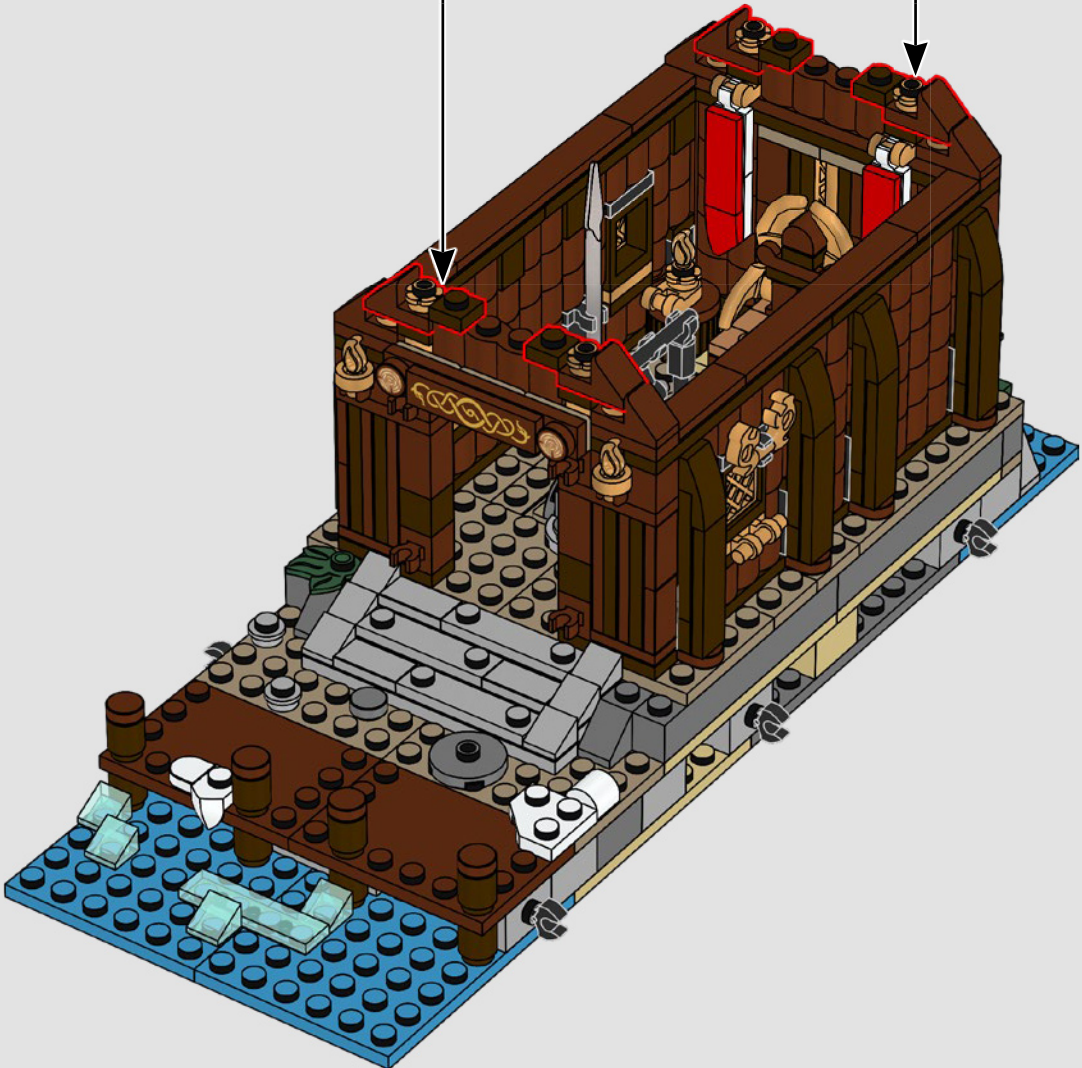
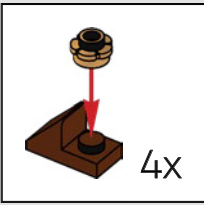

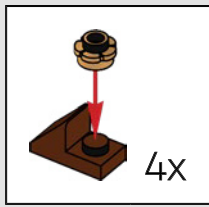
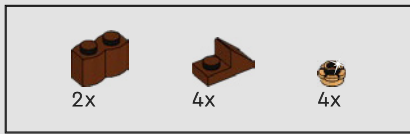

206

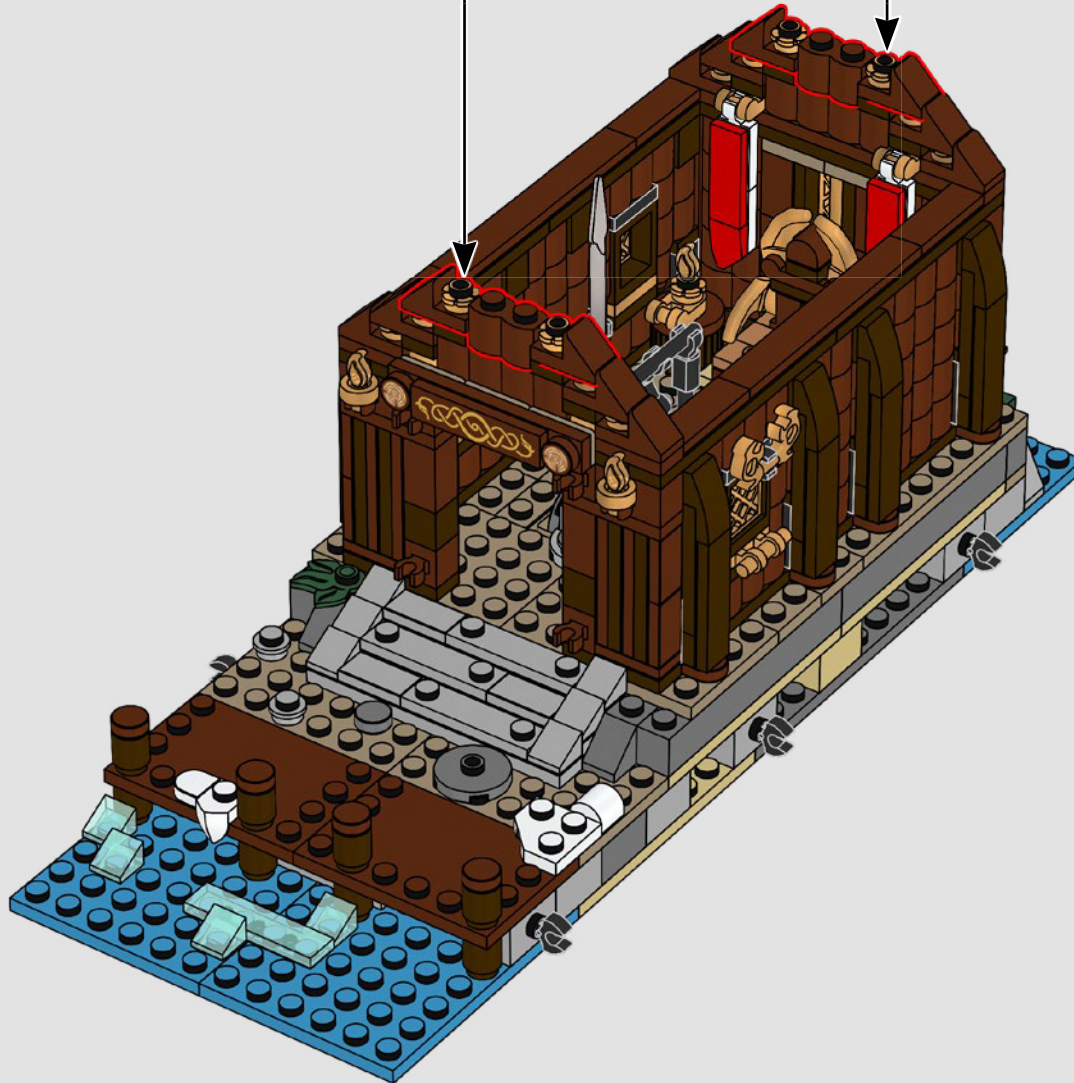



207

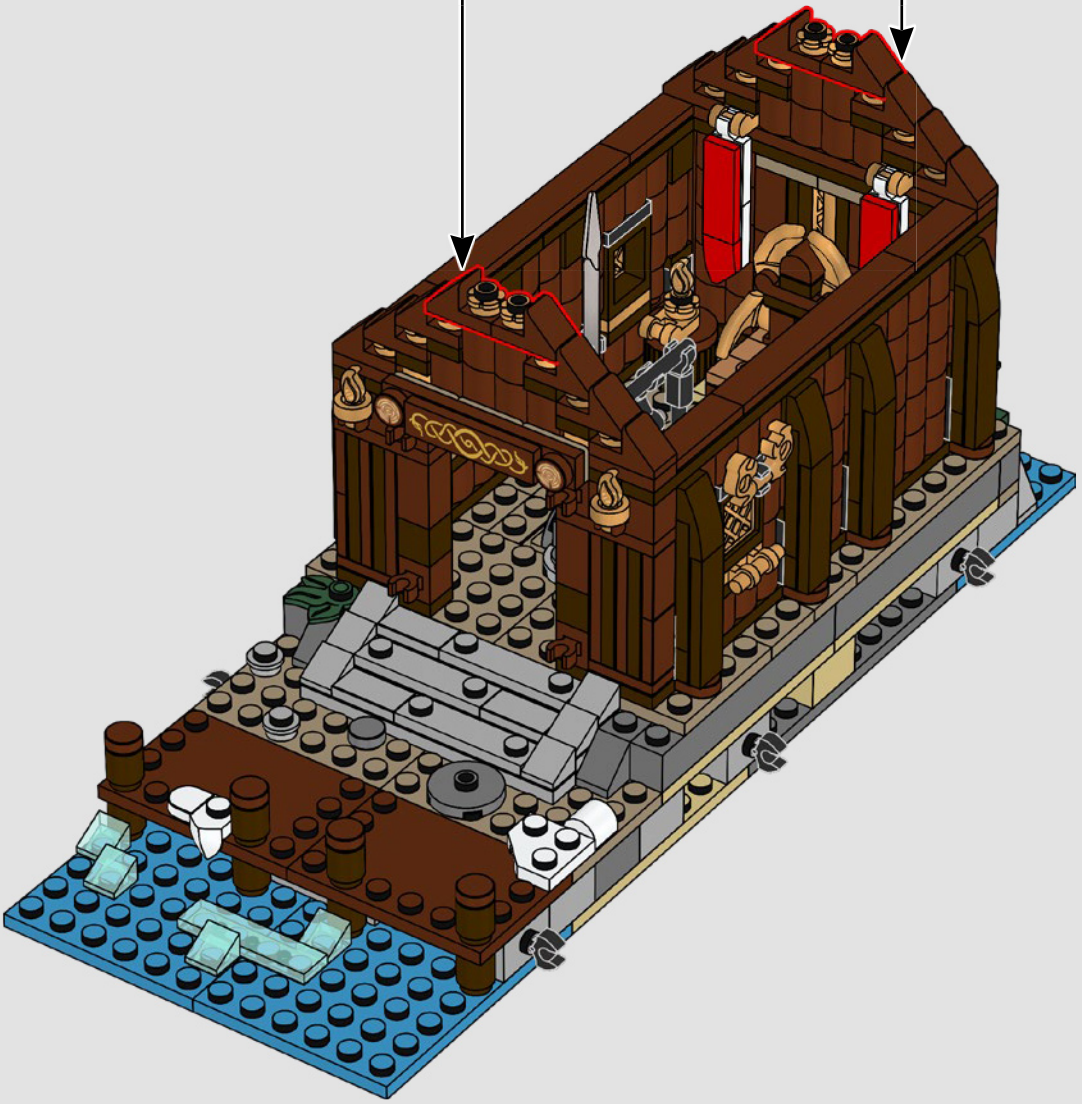
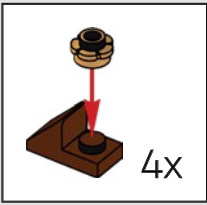

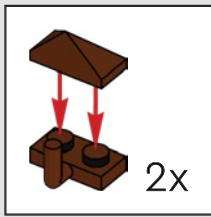

208

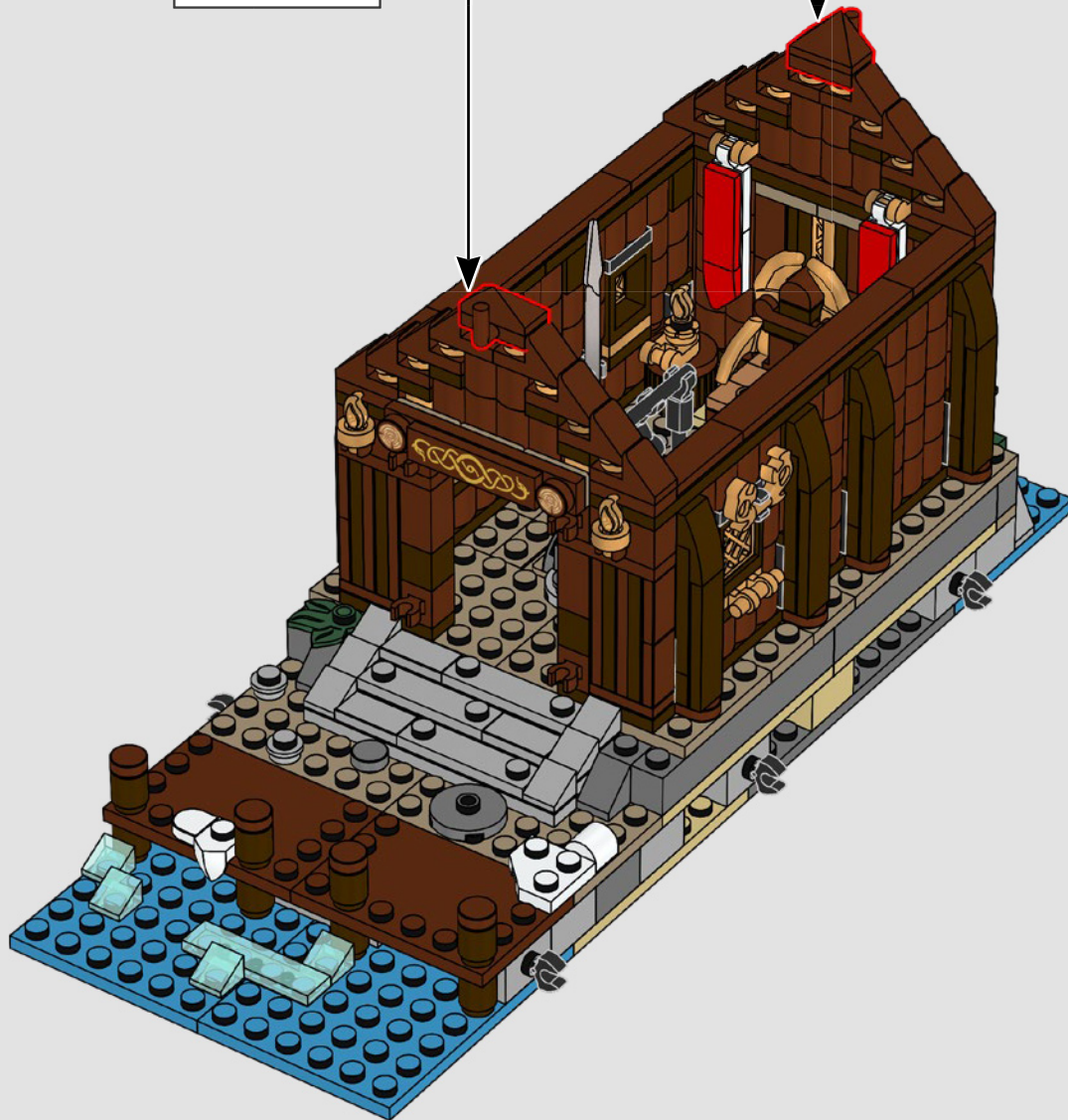

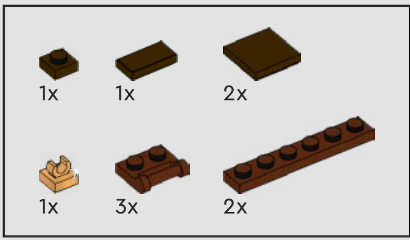

209

1

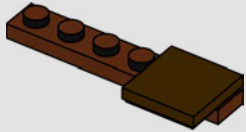

2

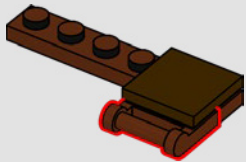

3

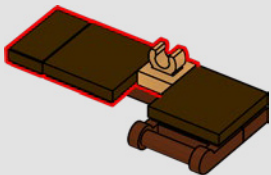

4

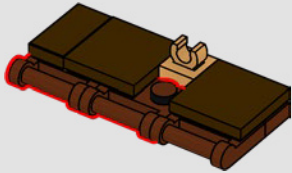

5

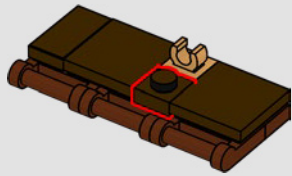

6

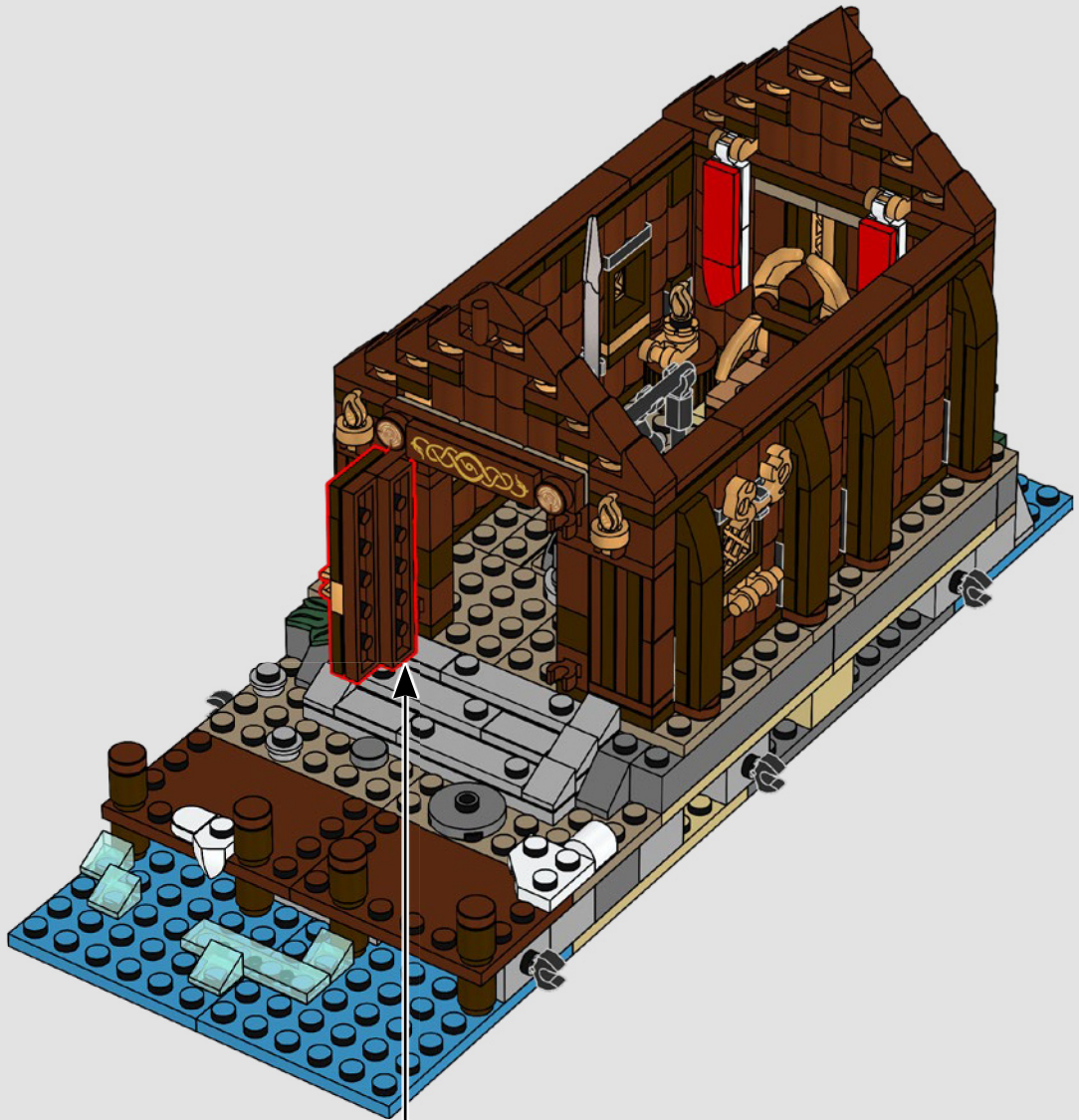
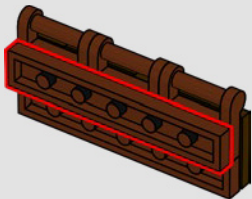

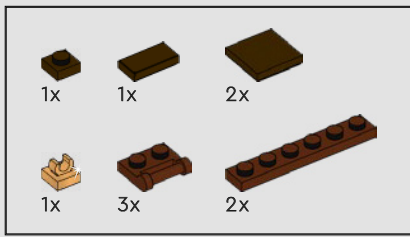

210

1

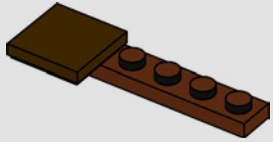

2

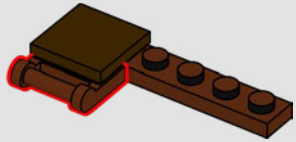

3

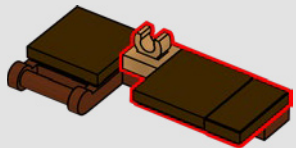

4

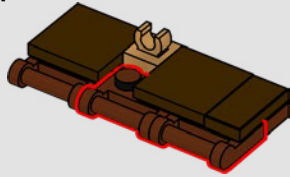

5

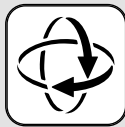
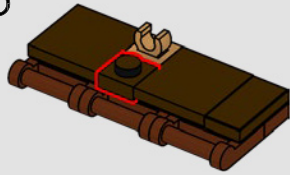

6

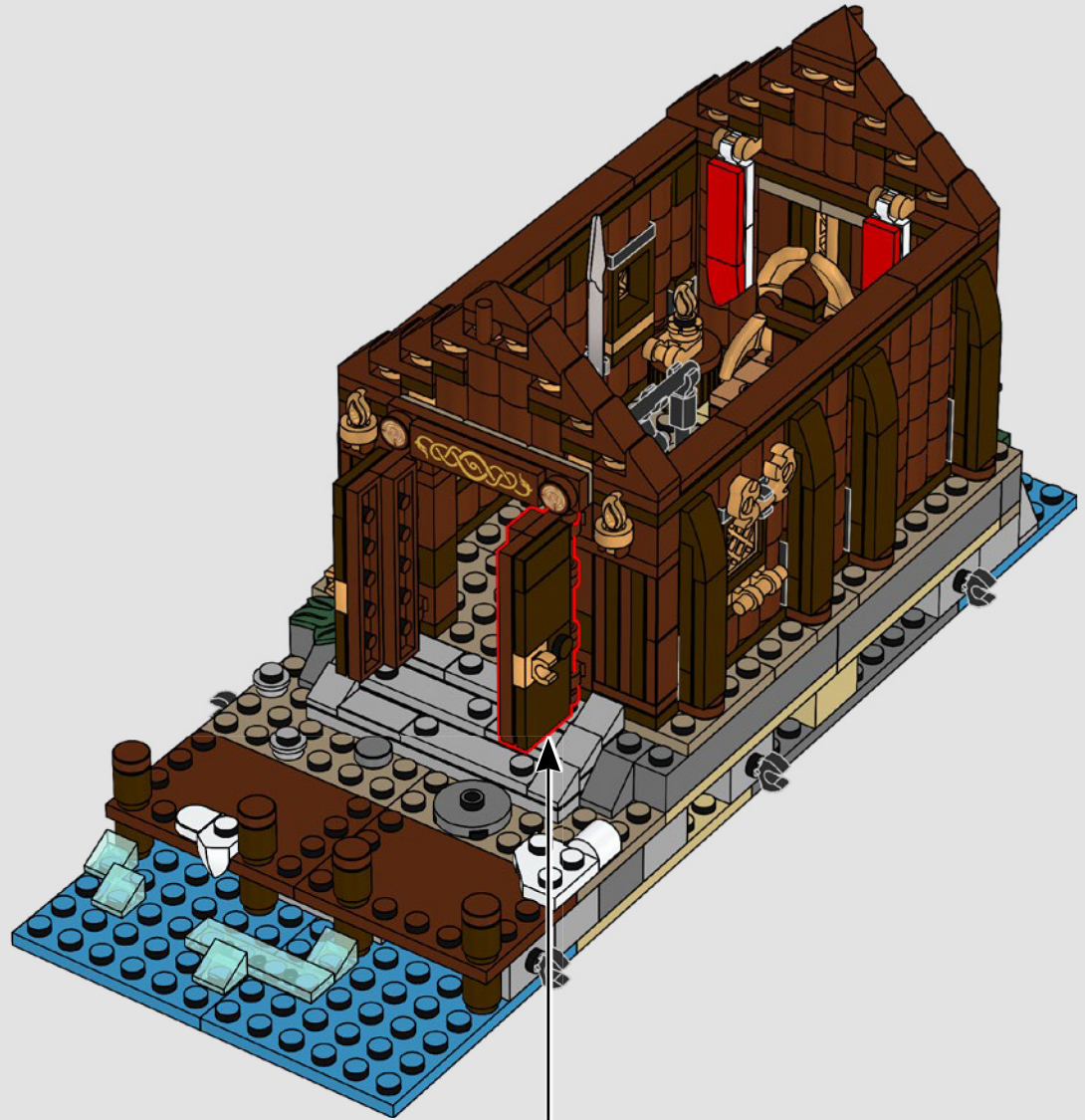
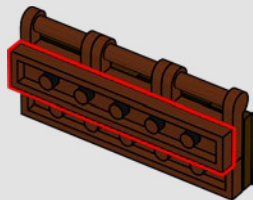

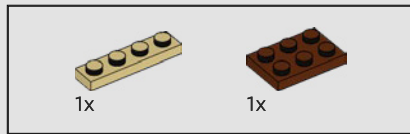
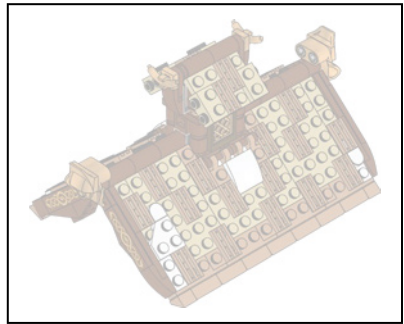

211

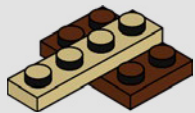

212

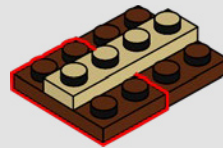

213

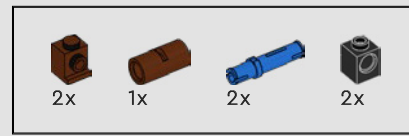

214

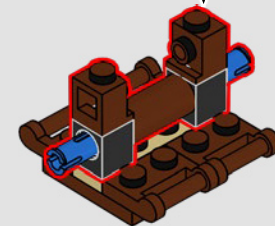
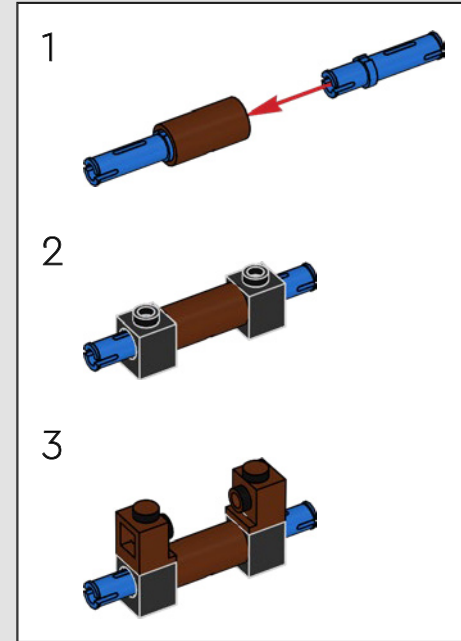

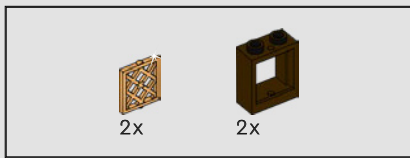

215

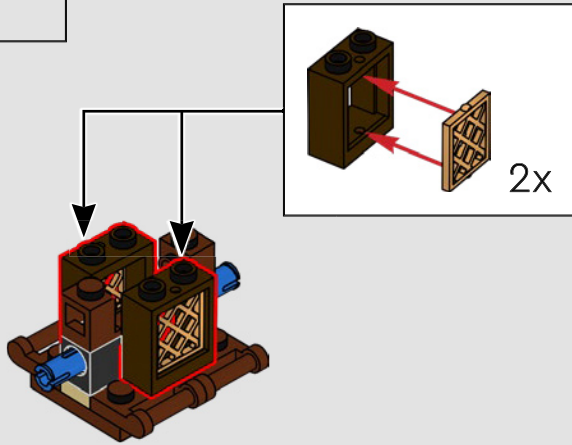

217

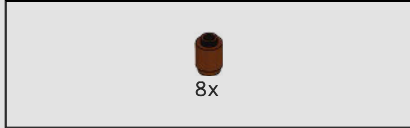
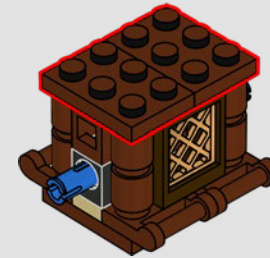

216

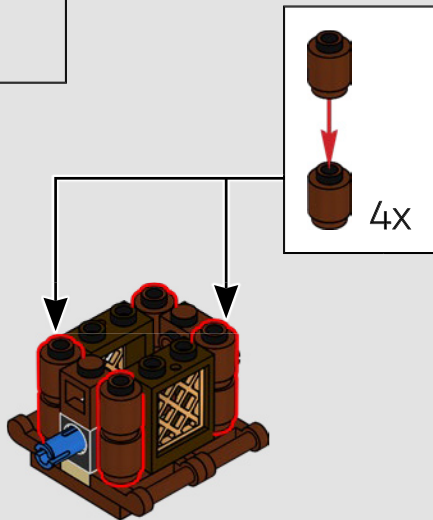

218

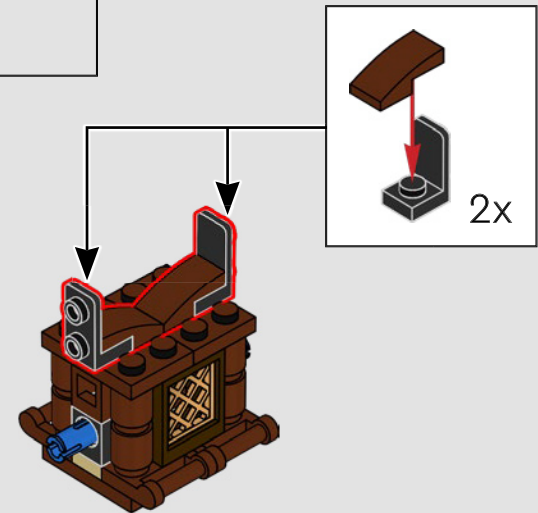



219

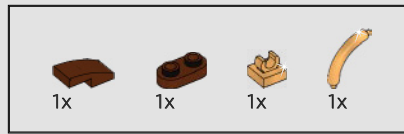
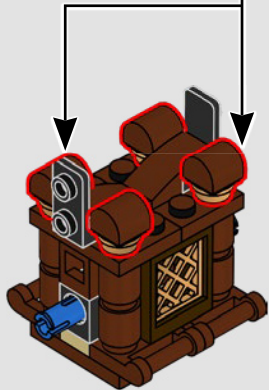
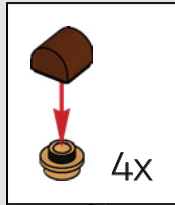

220

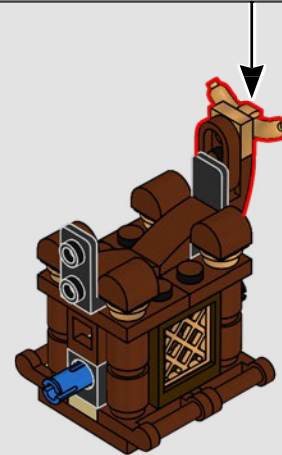
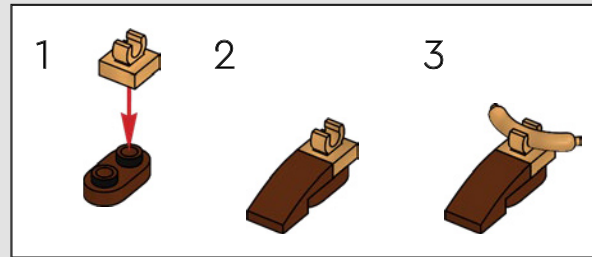

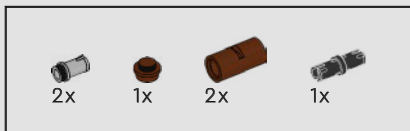

221

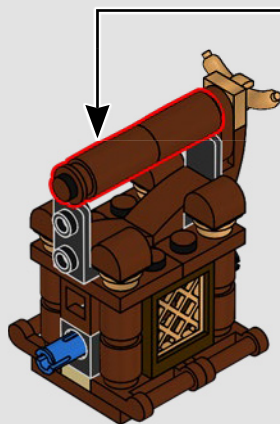
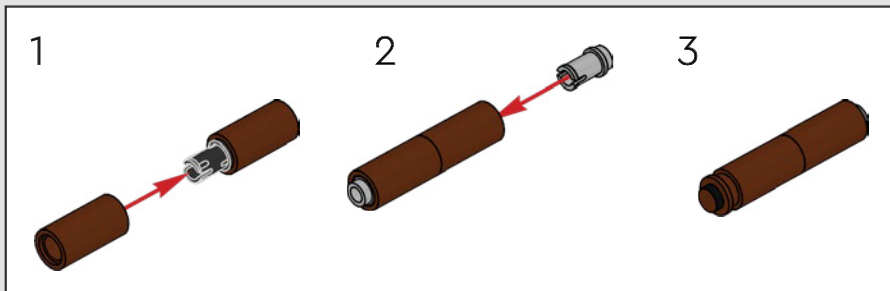

222

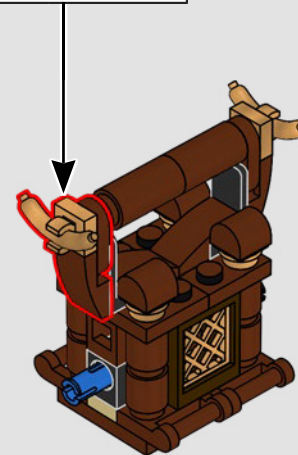
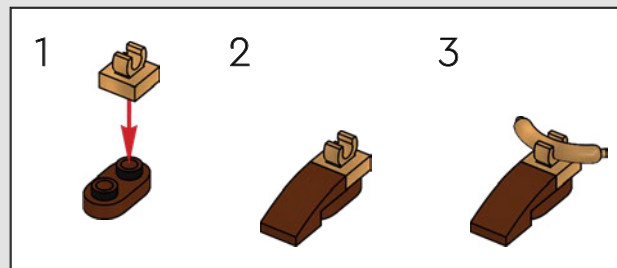

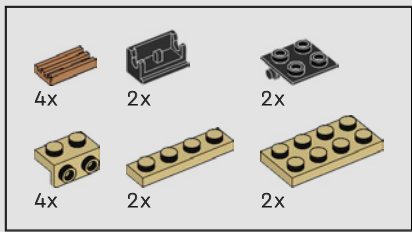

223

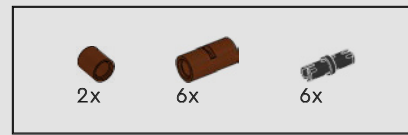
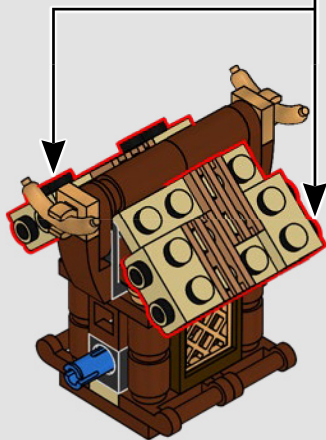
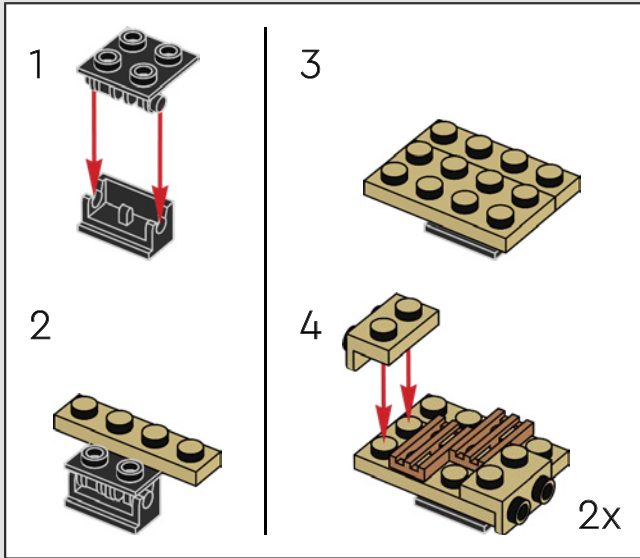

224

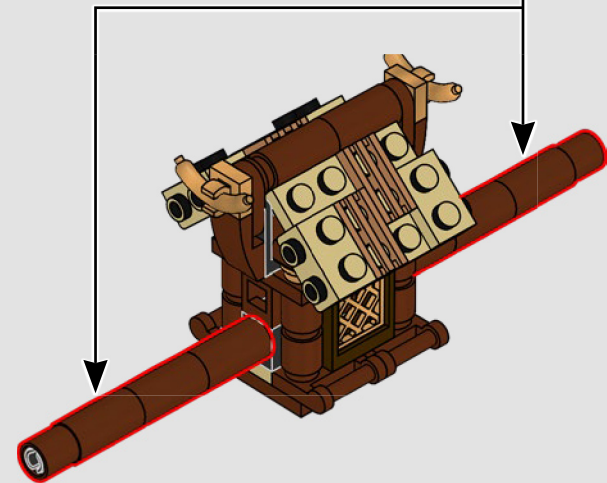
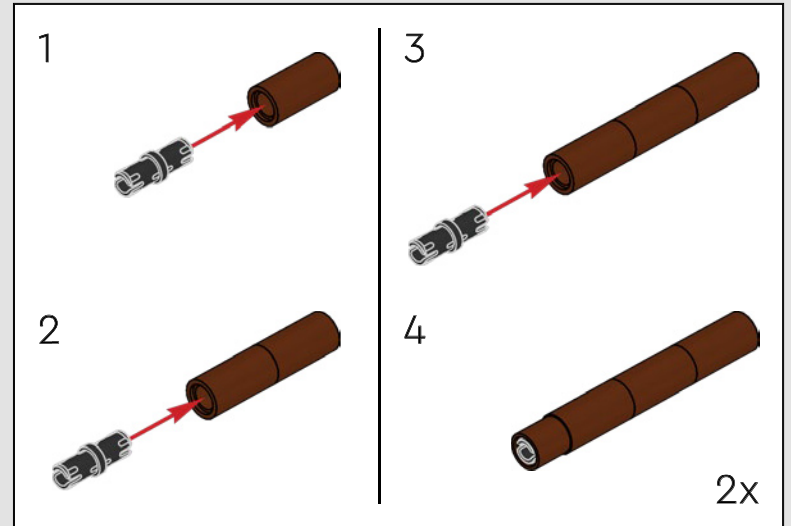

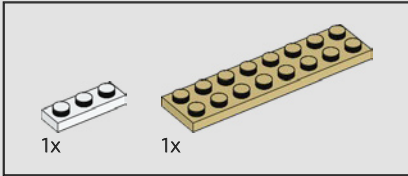
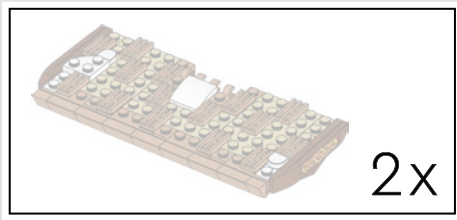

225

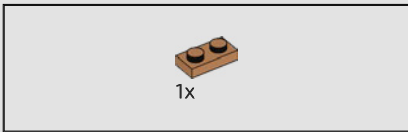
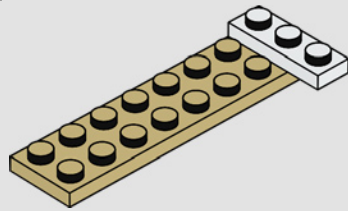

226

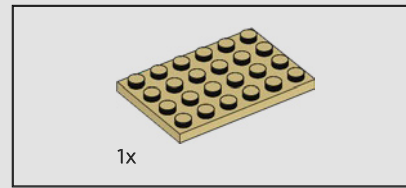
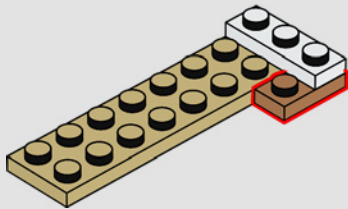

227

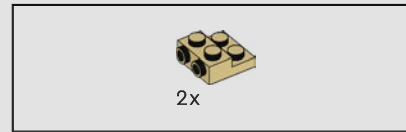
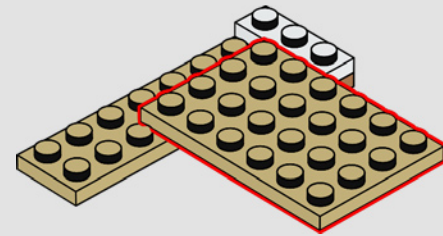

228

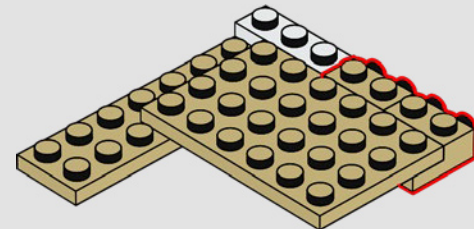



229

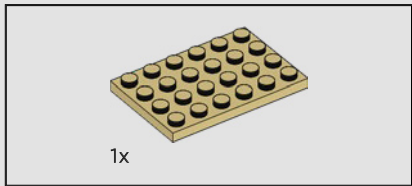
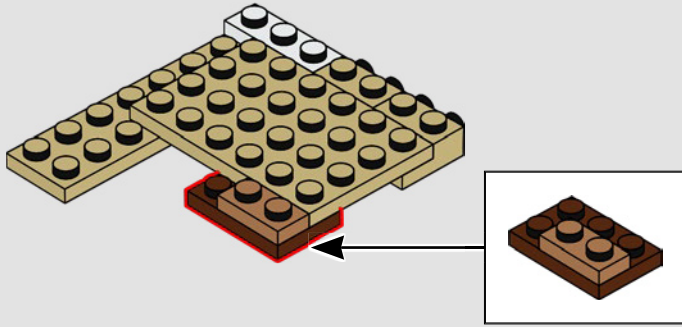

230

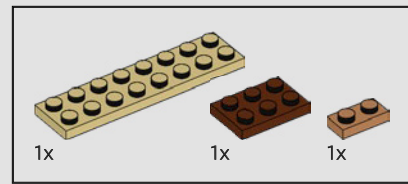
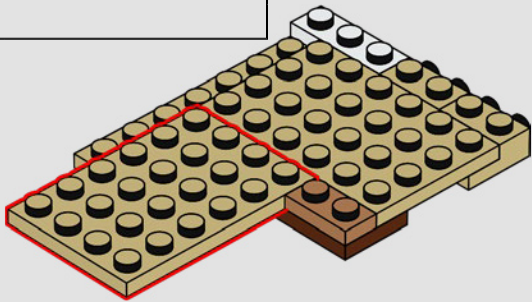

231

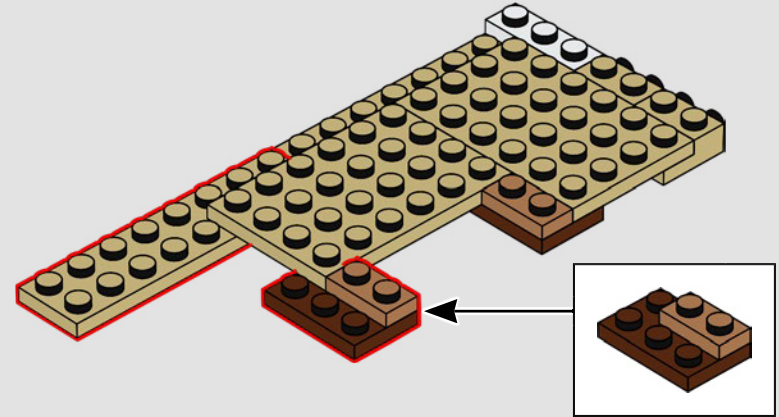

232

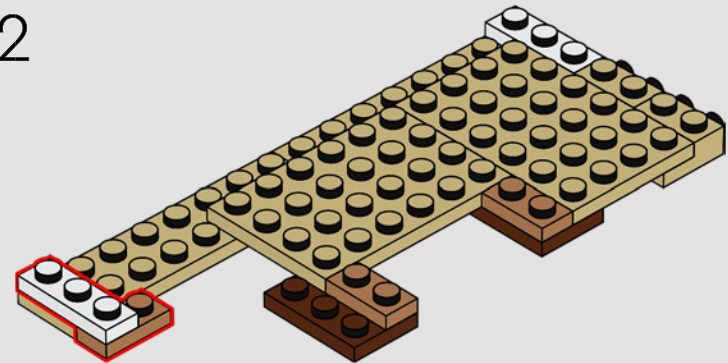

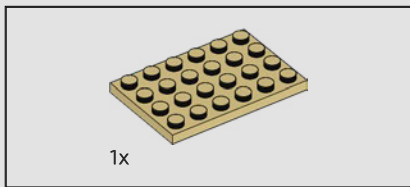

233

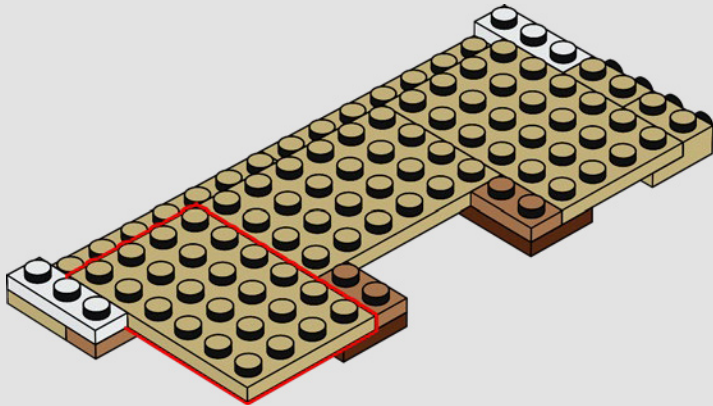

234

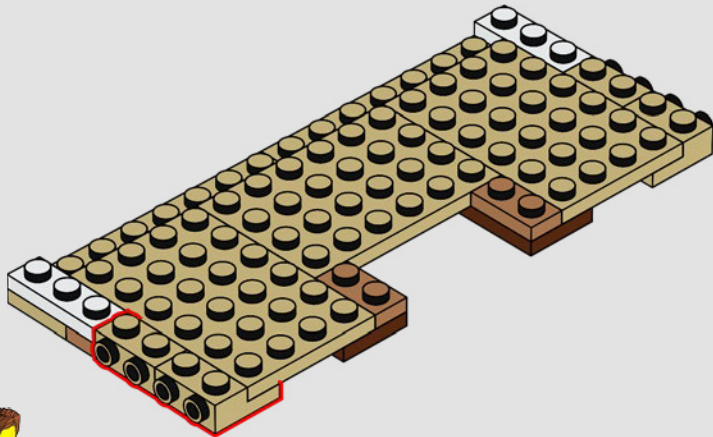

235



236

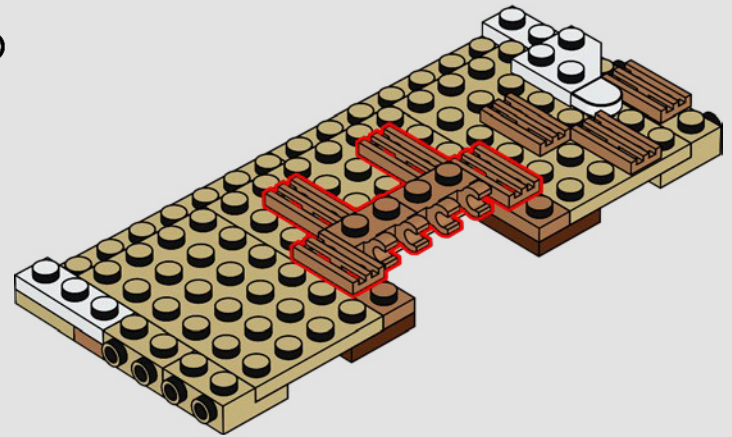

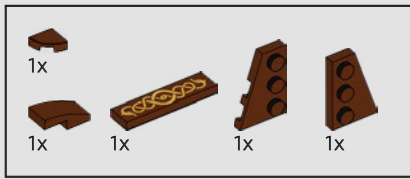

240

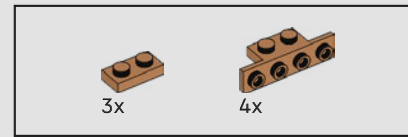
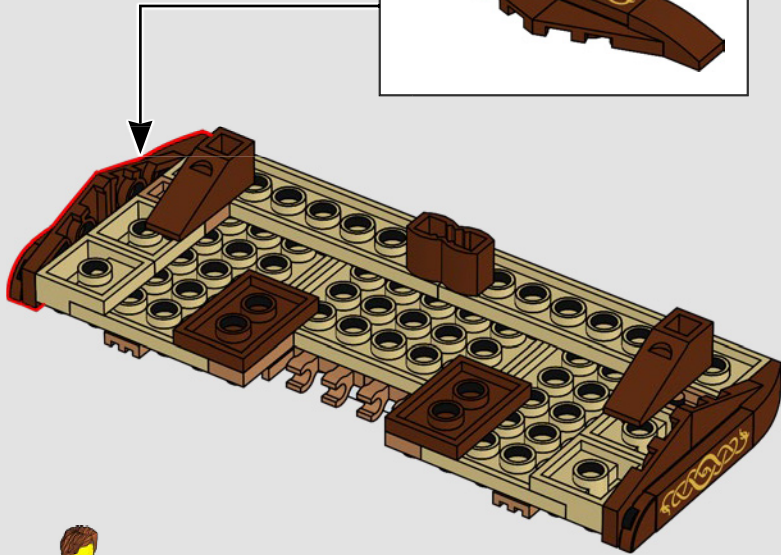
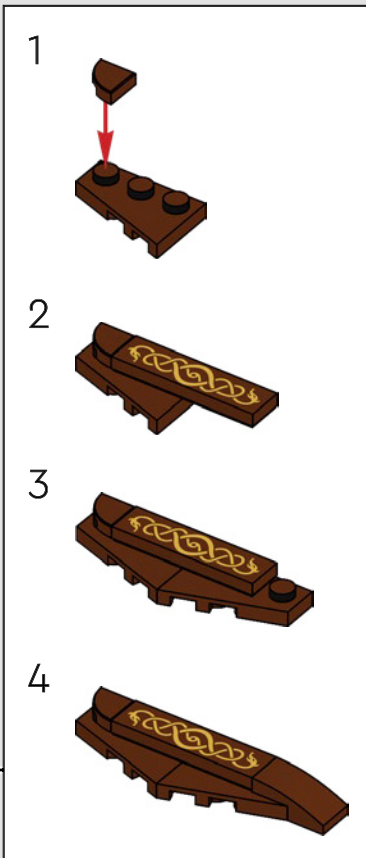

241

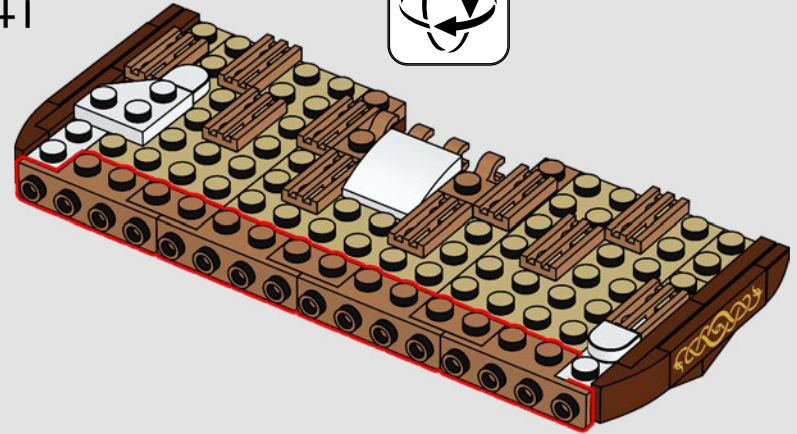
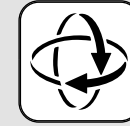

242

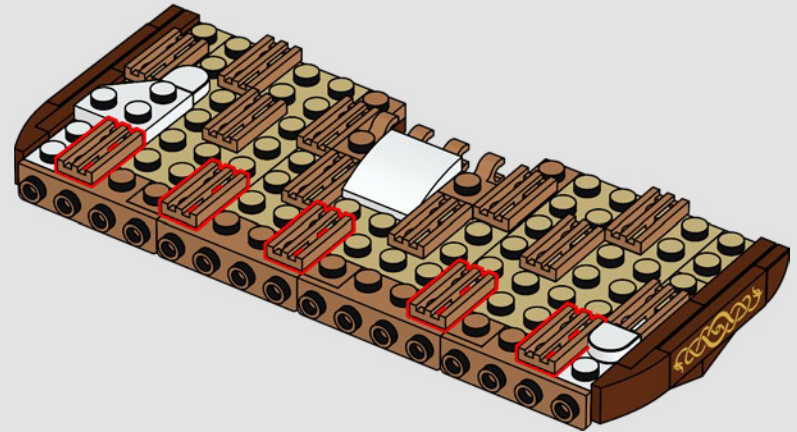

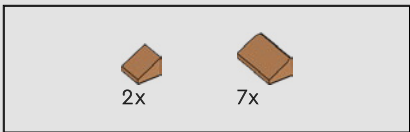

243

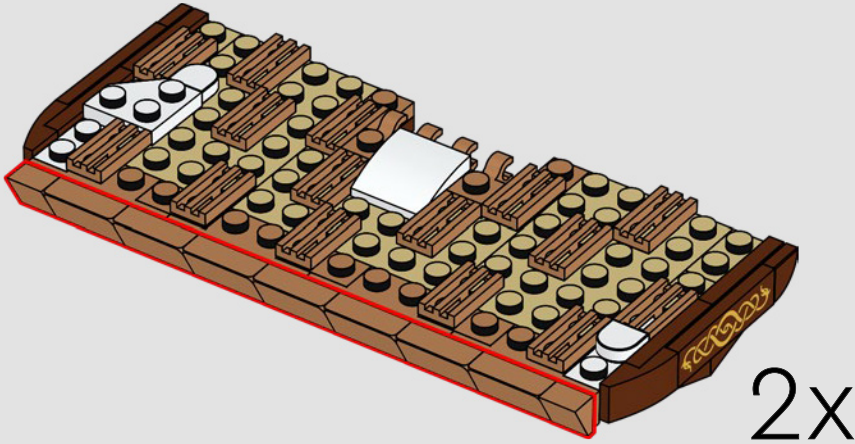

244

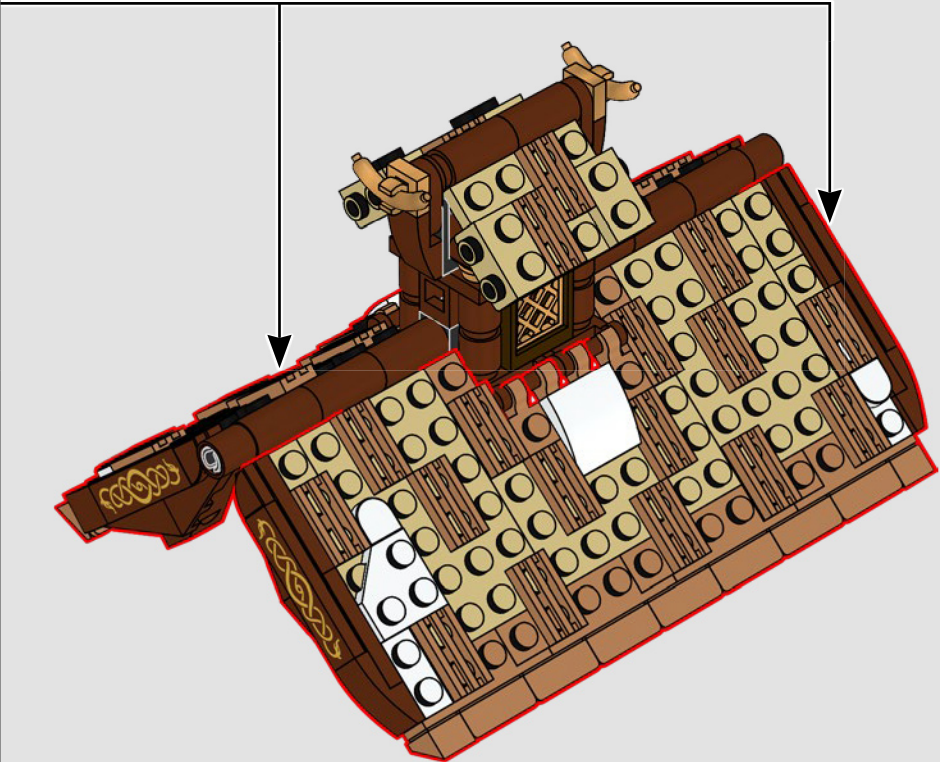

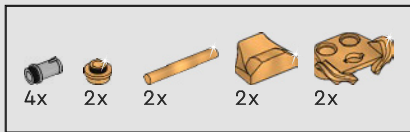

245

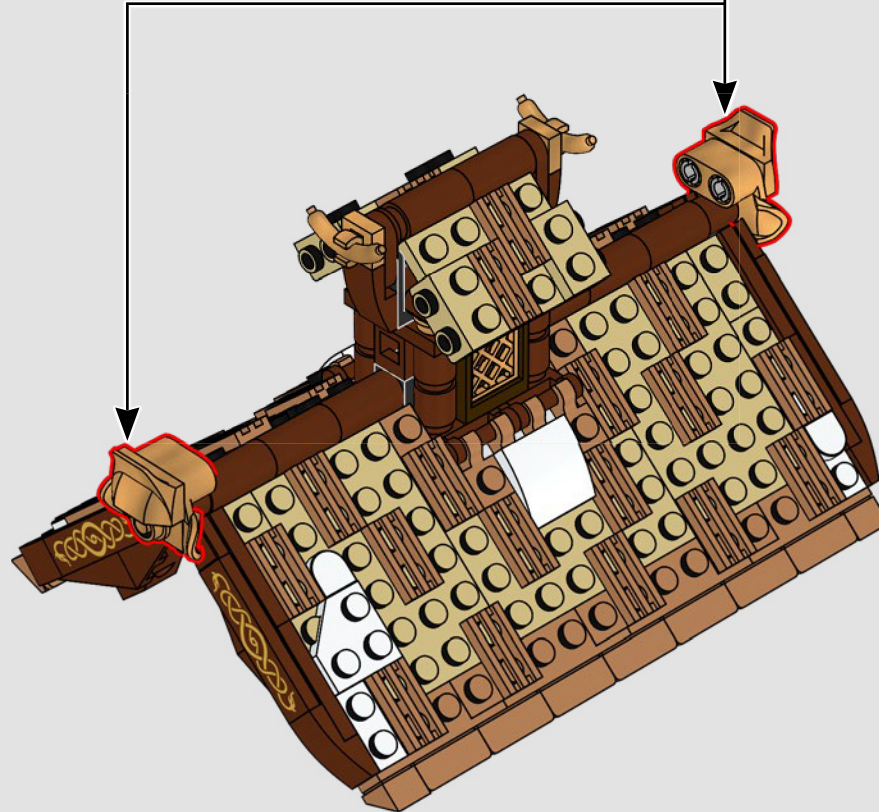
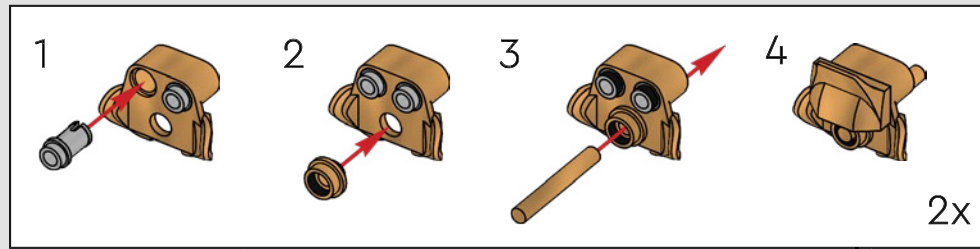

246

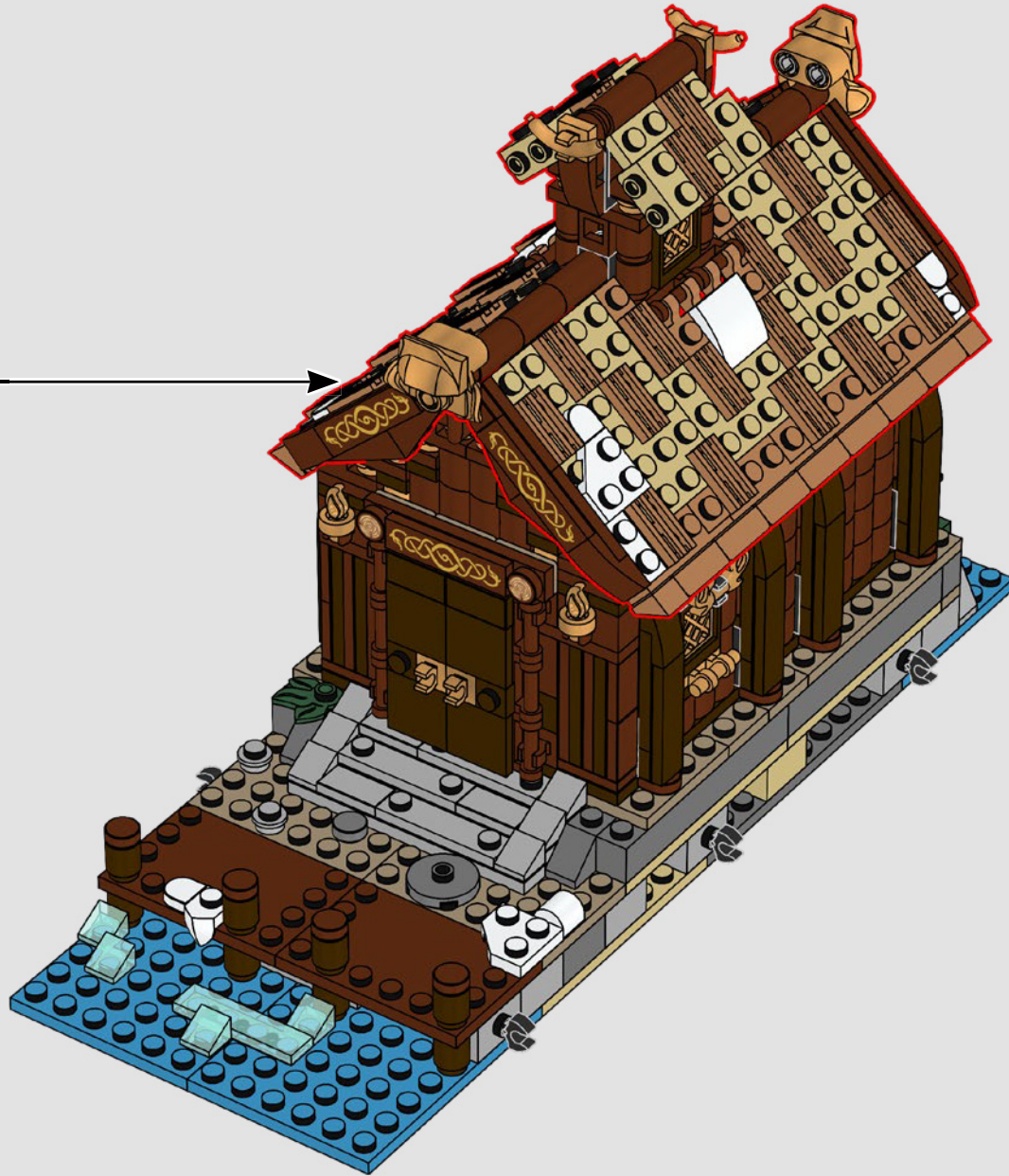

247



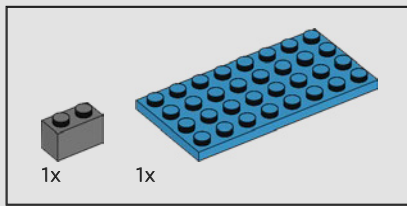

248

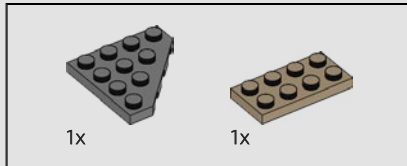
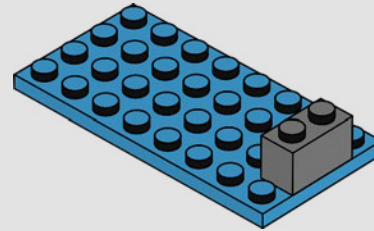

249

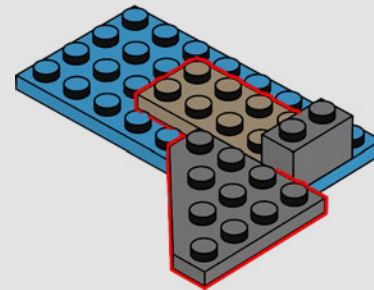

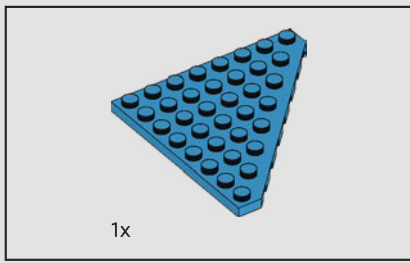

250

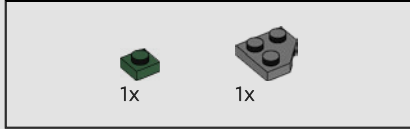
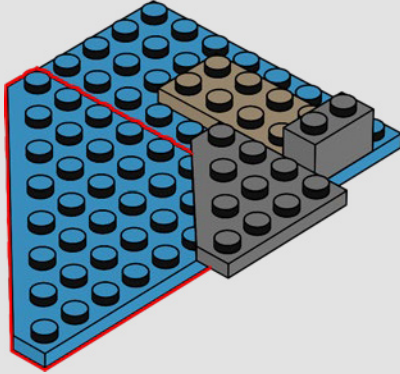

251

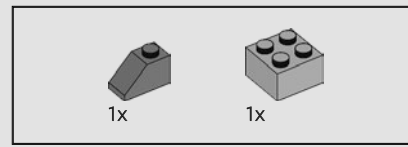
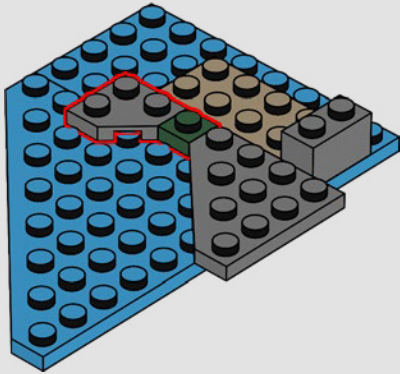

252

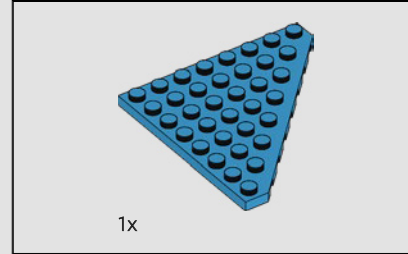
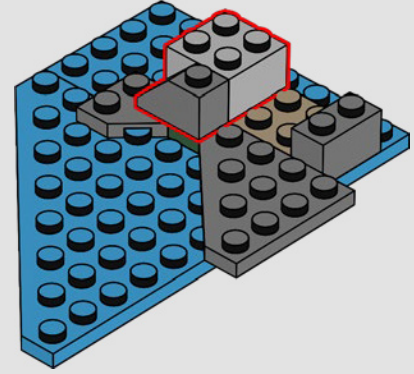

253

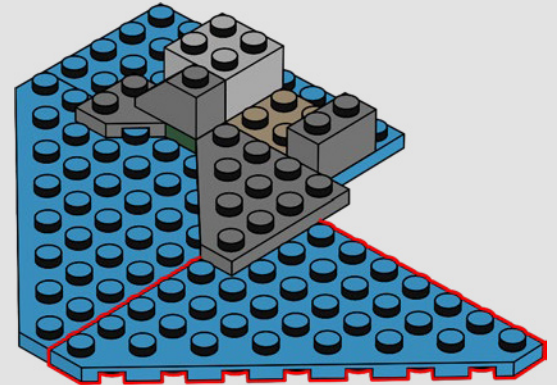

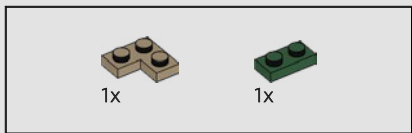

254

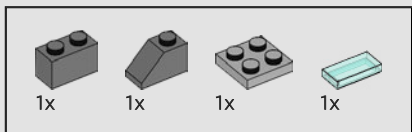
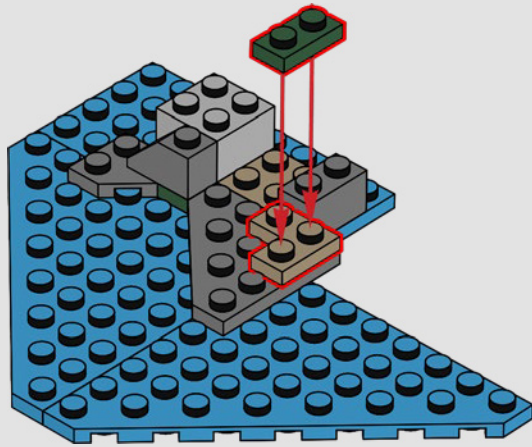

255

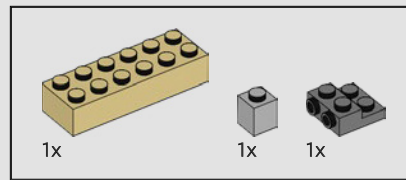
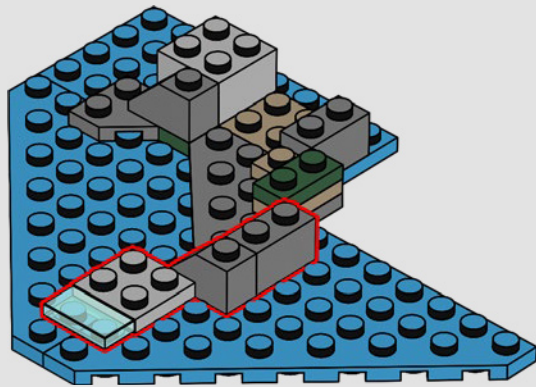

256

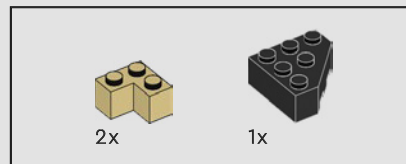
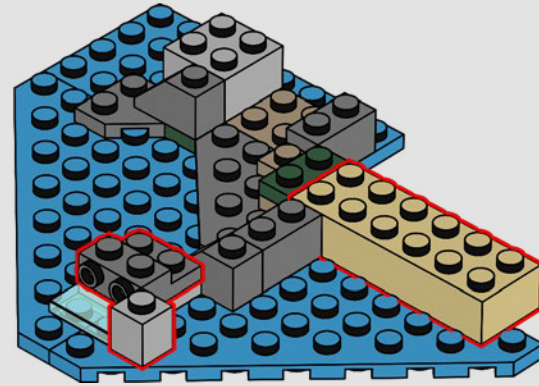

257

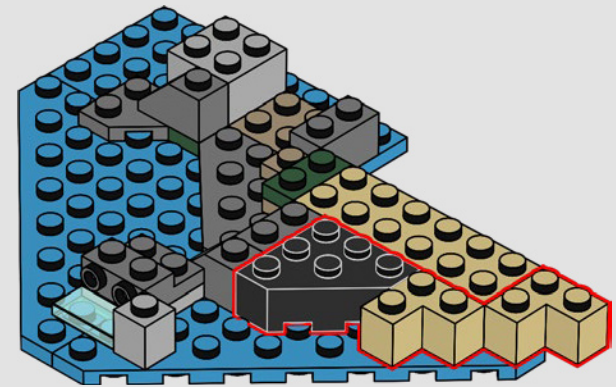



258

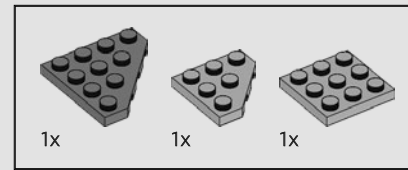
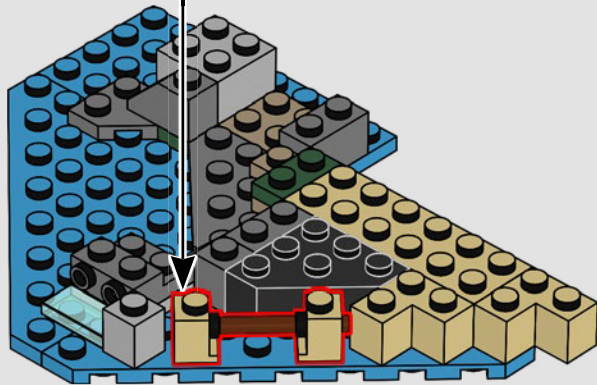
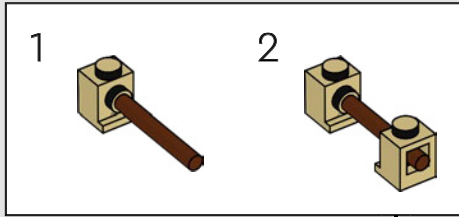

259

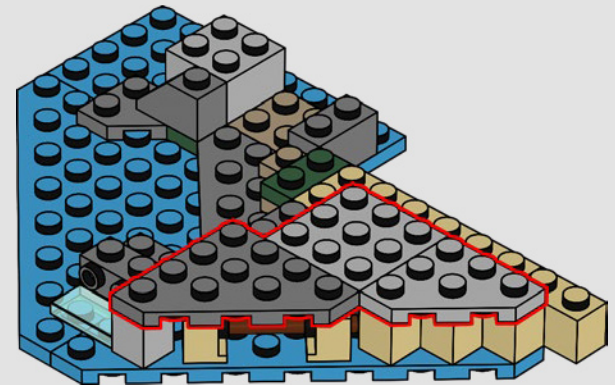

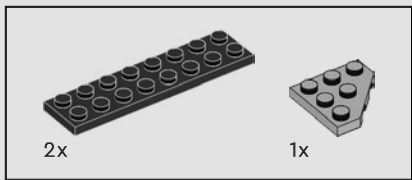

260

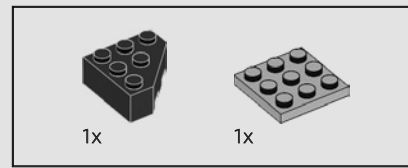
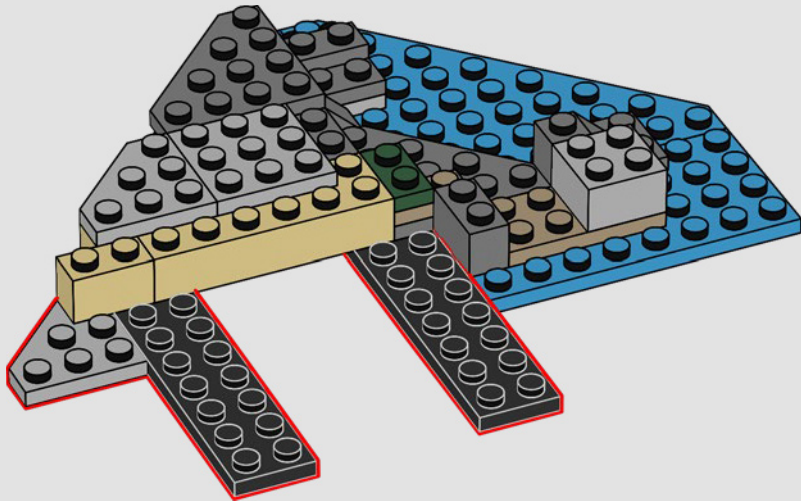

261

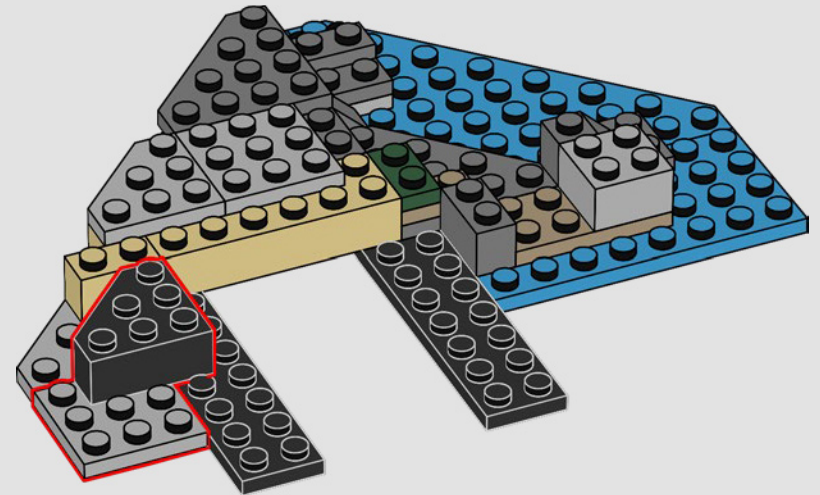

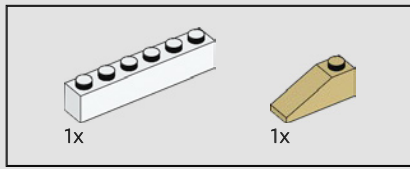

262

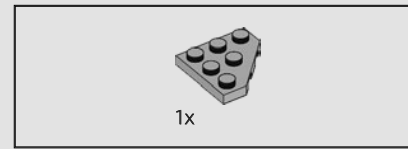
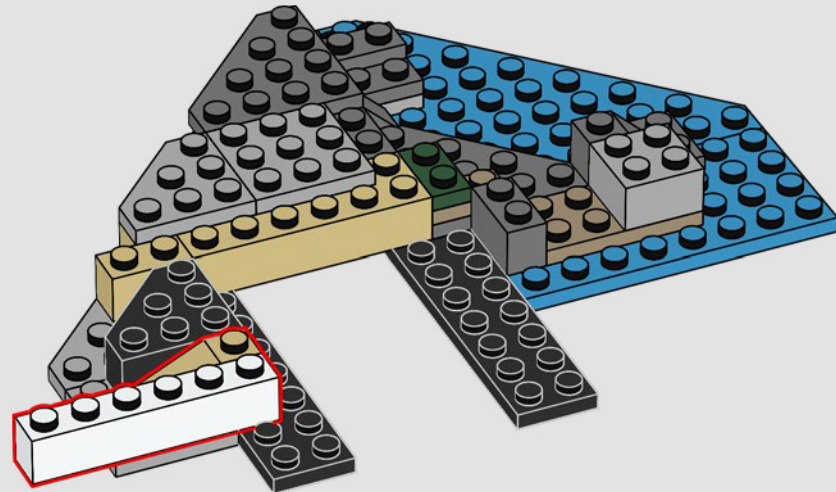

263

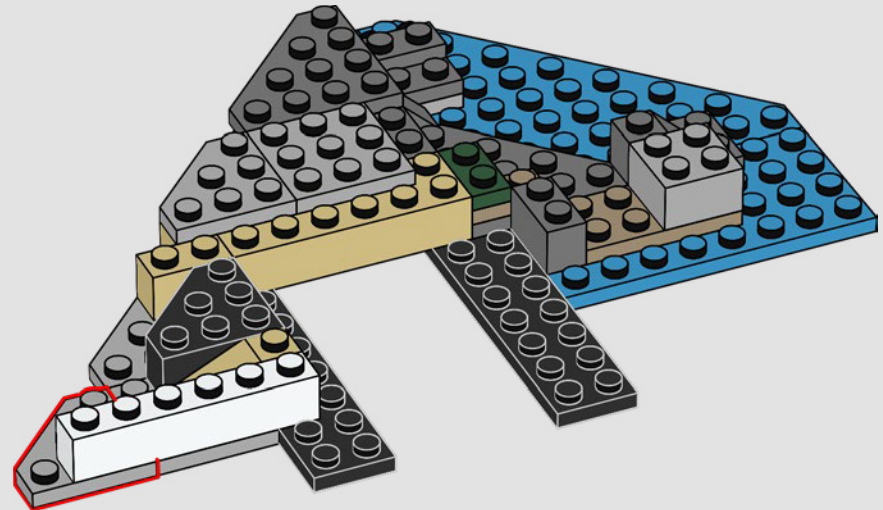



264

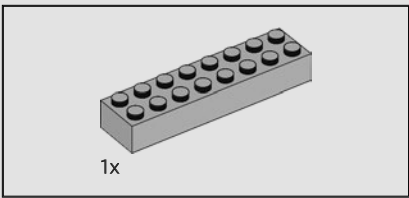
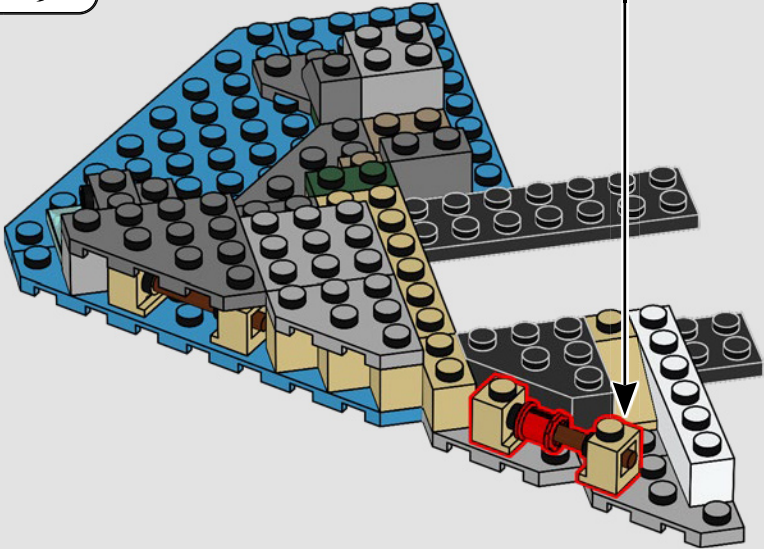
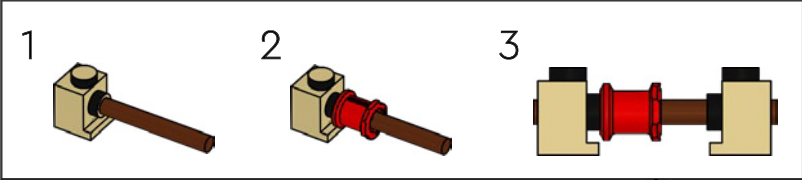

265

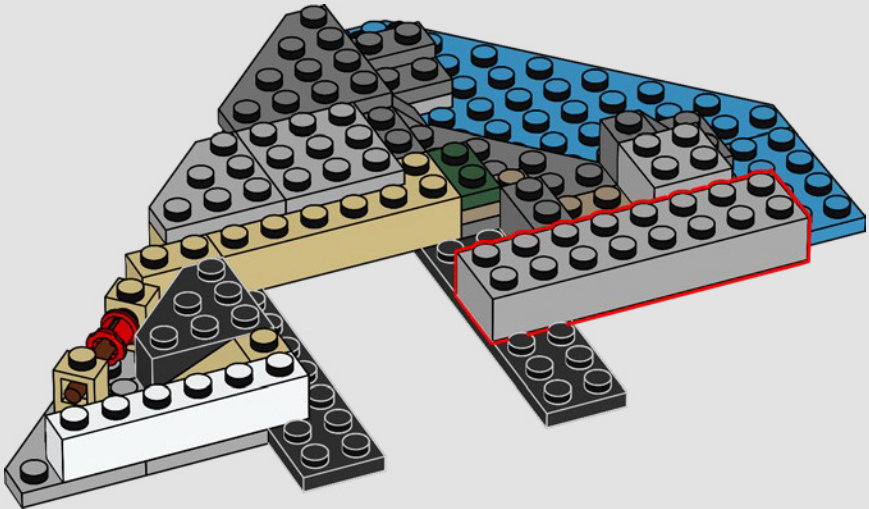

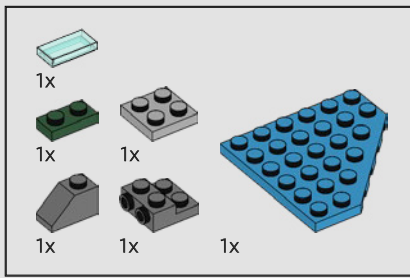

266

1

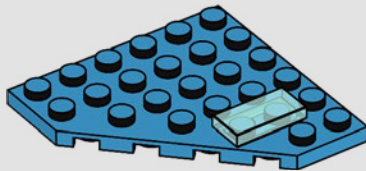

2

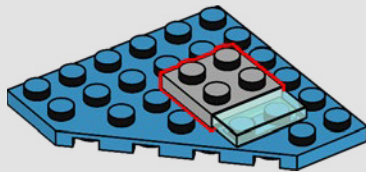

3

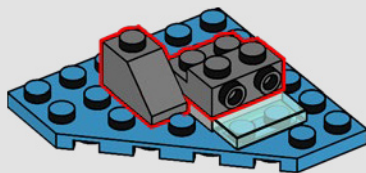

4

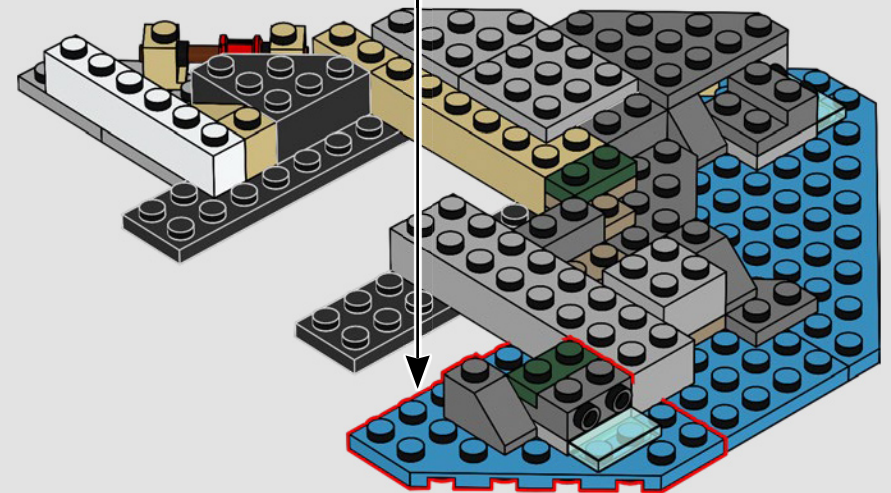
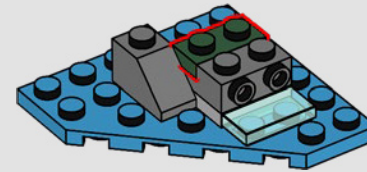

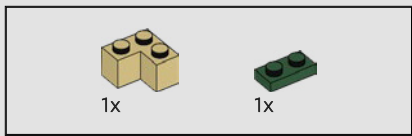

267

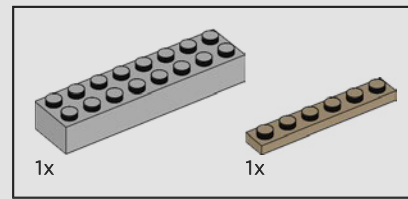

268

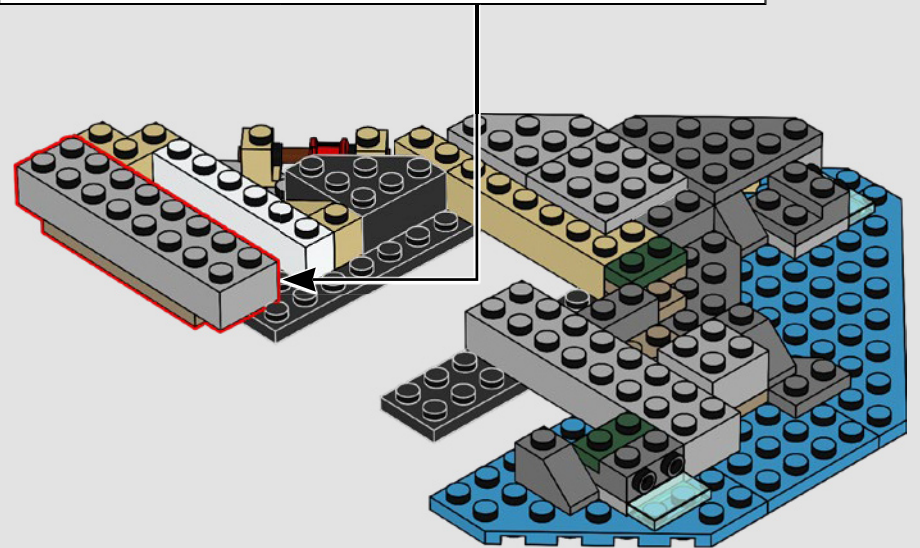
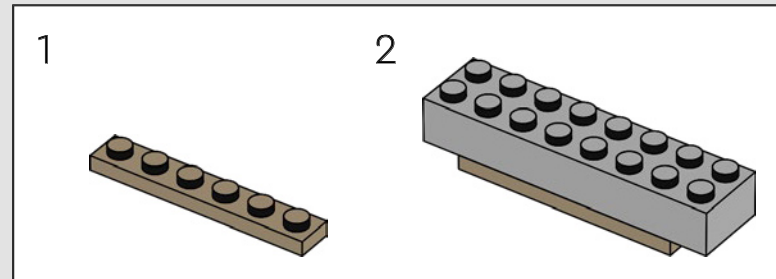

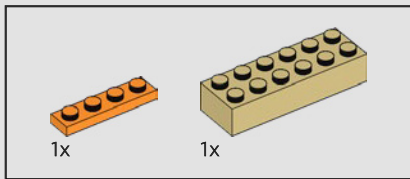

269

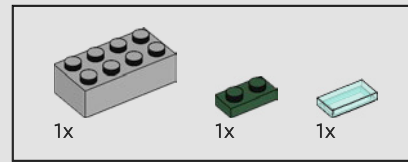
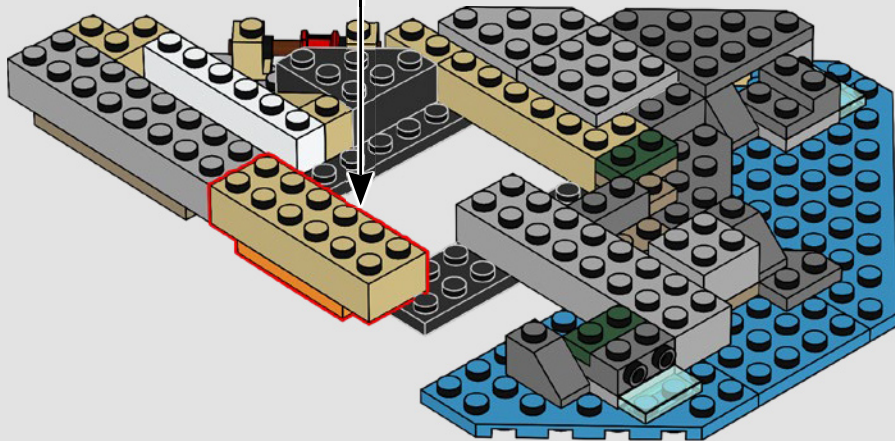
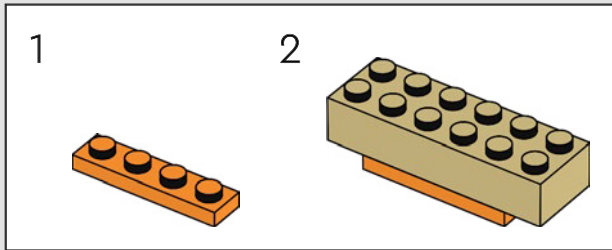

270

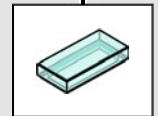
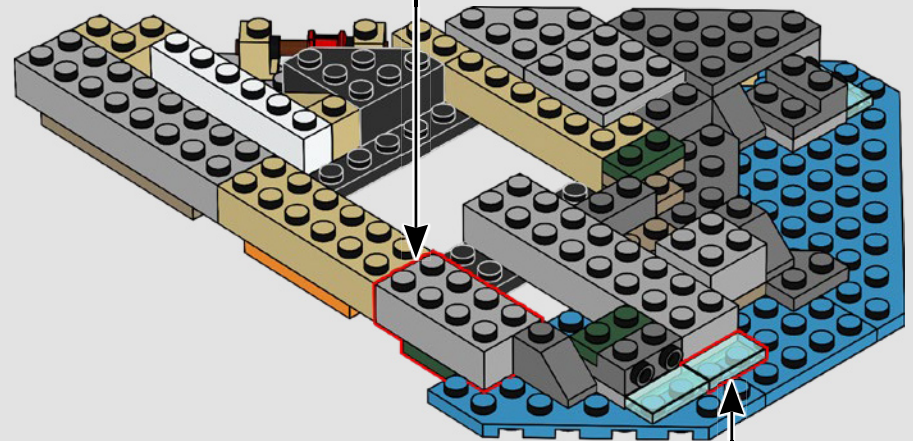
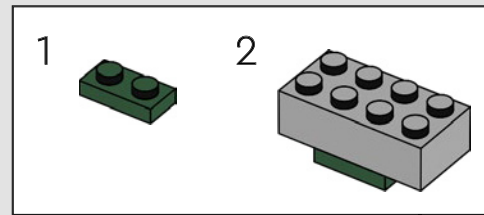

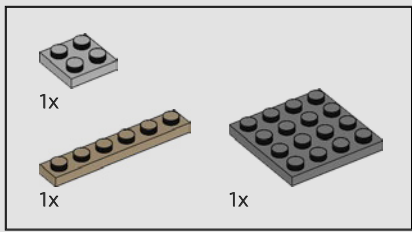

271

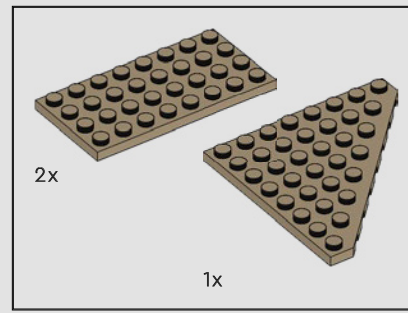
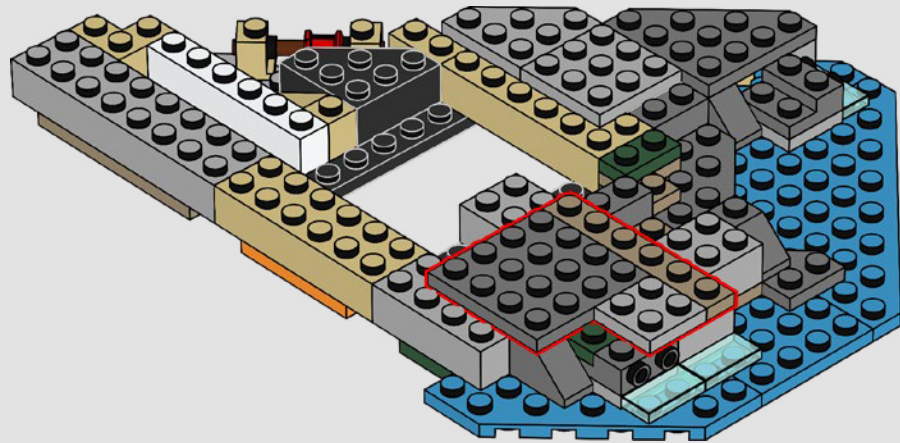

272





273



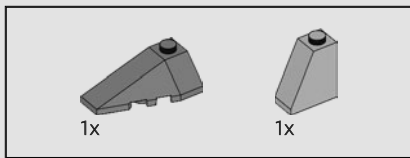

274

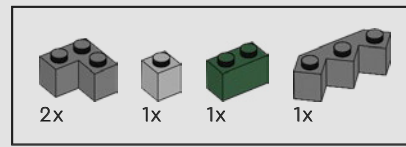

275



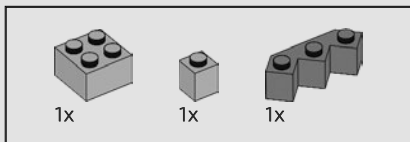

276

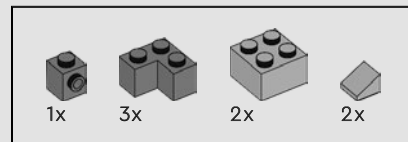

277

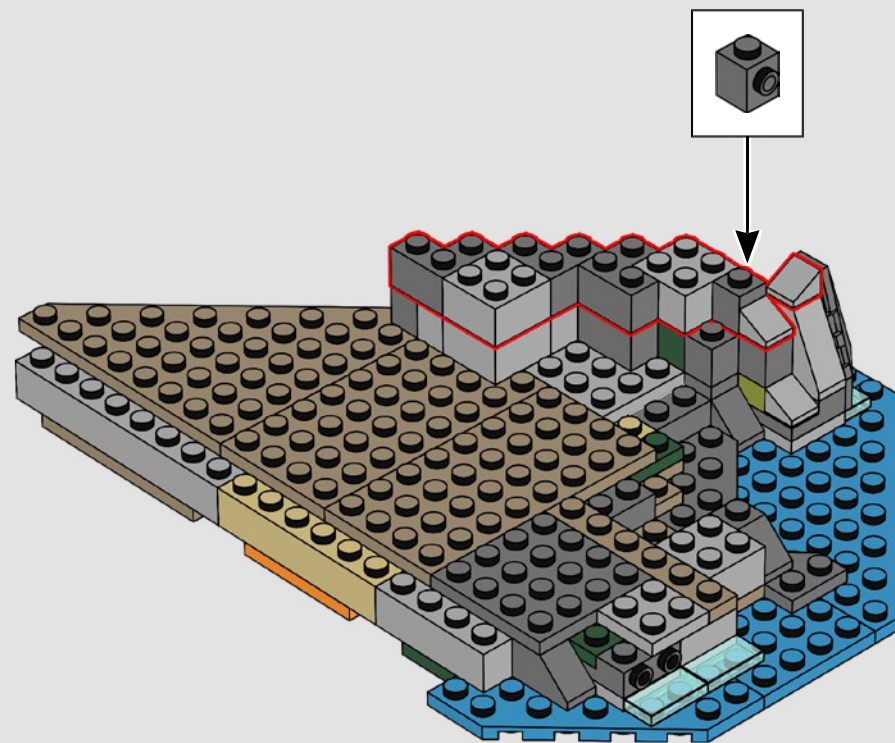

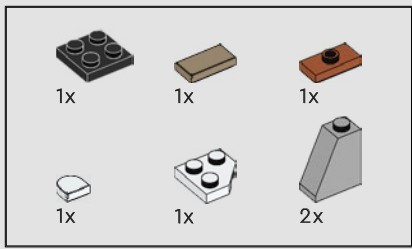

278

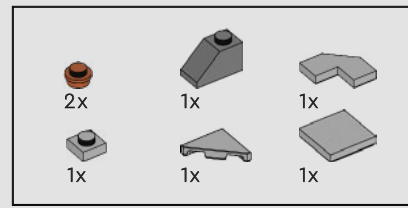
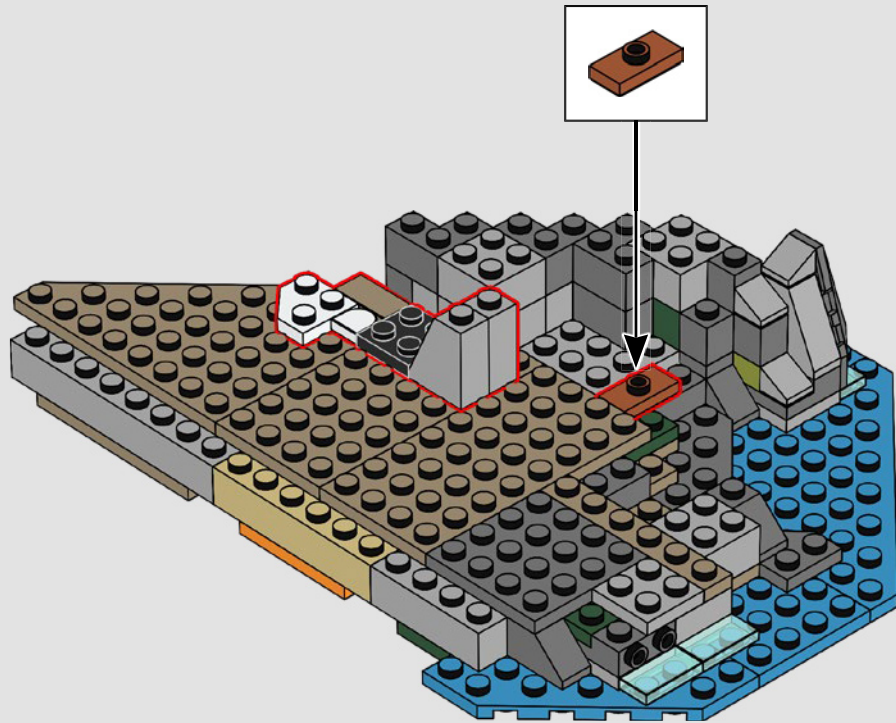

279

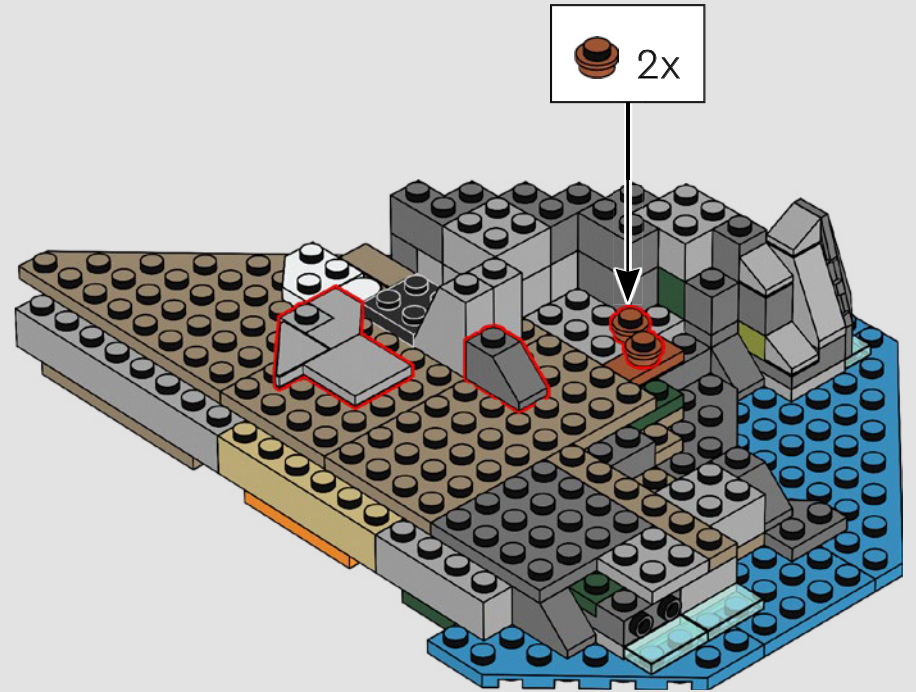

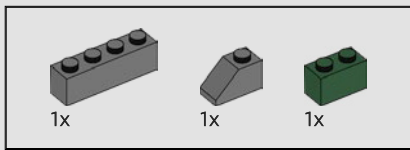

280

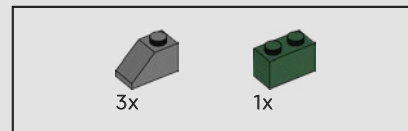
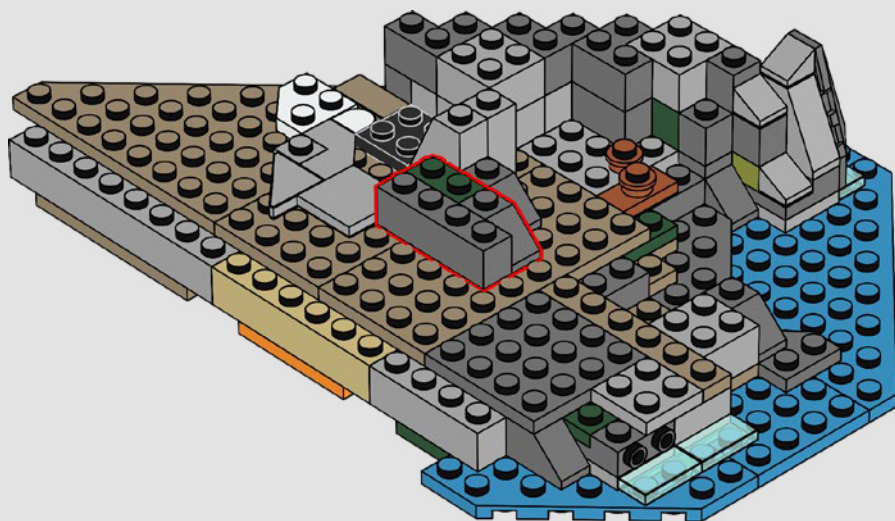

281



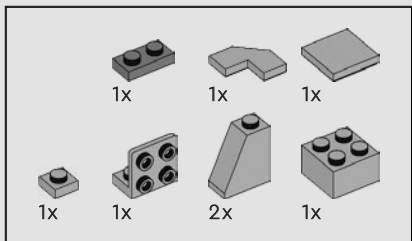

282

1



2

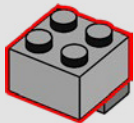

3

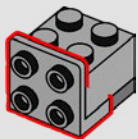

4

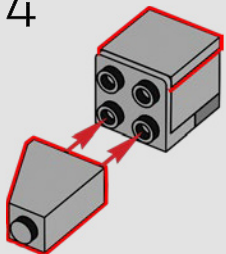

5

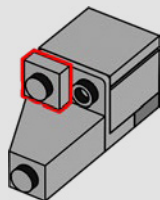

6

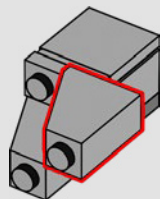

7

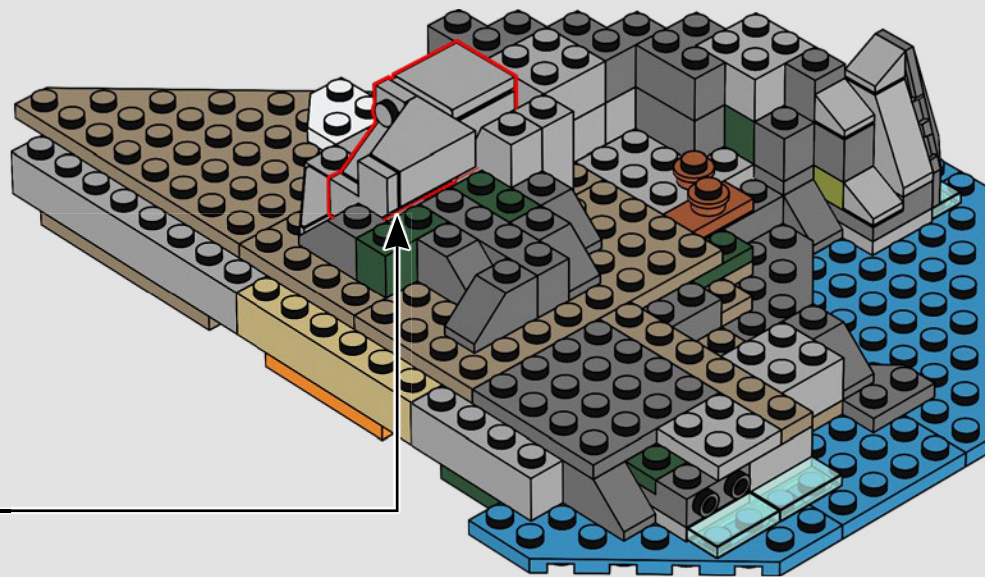
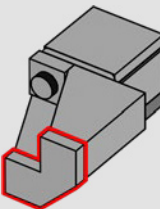

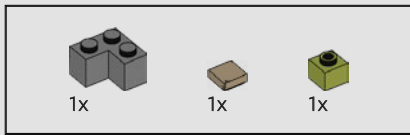

283

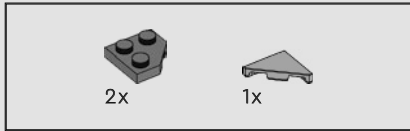
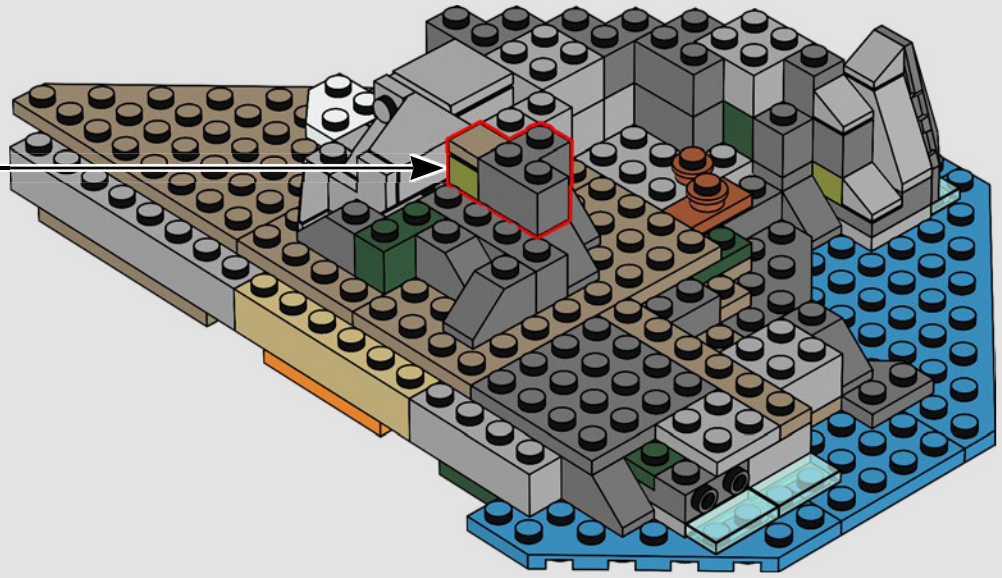
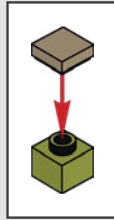

284

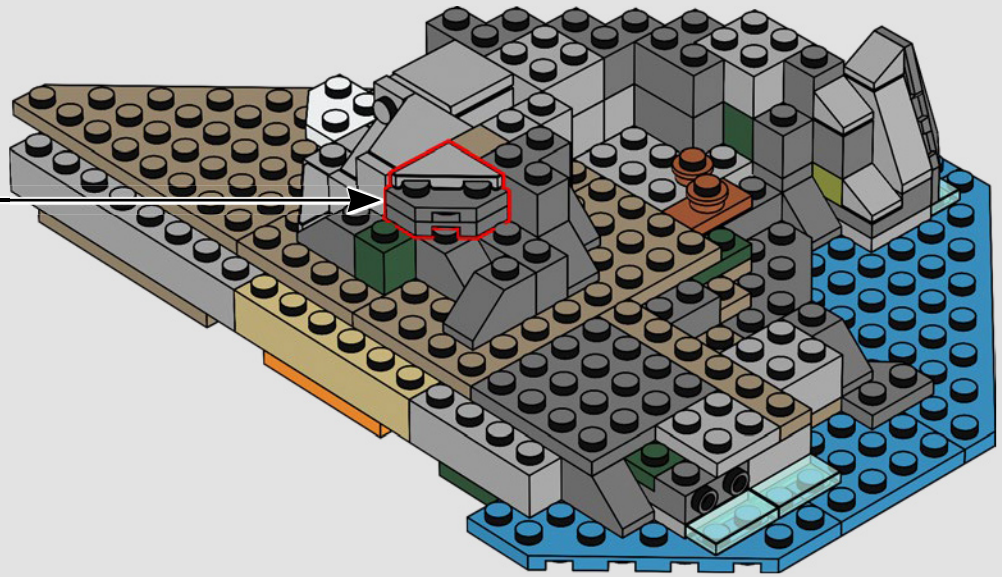
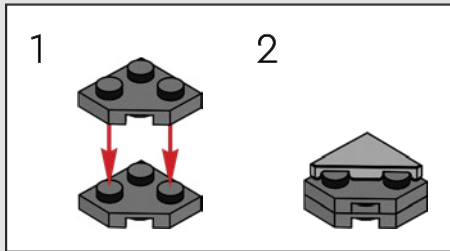

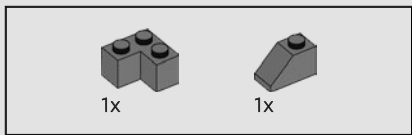

285

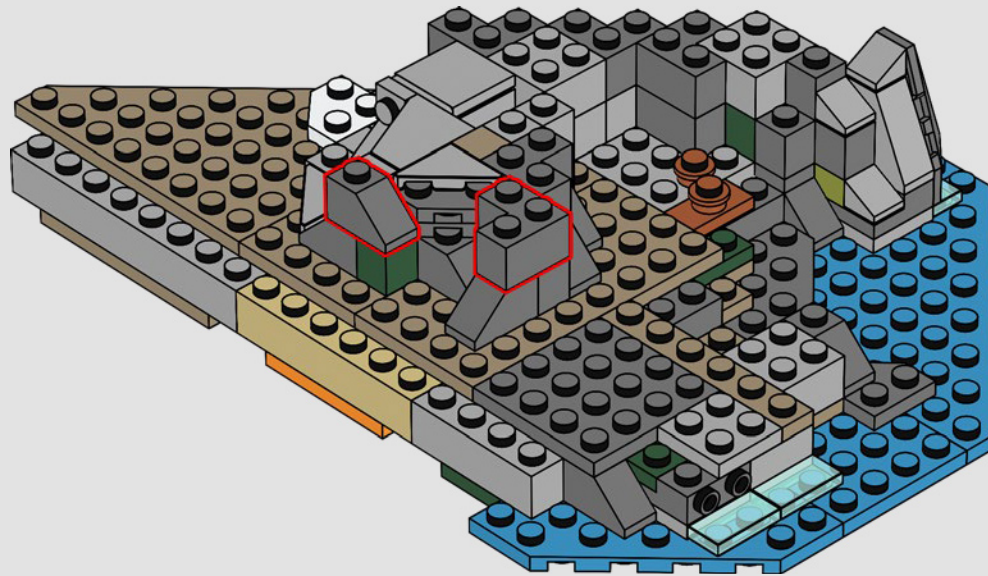

286

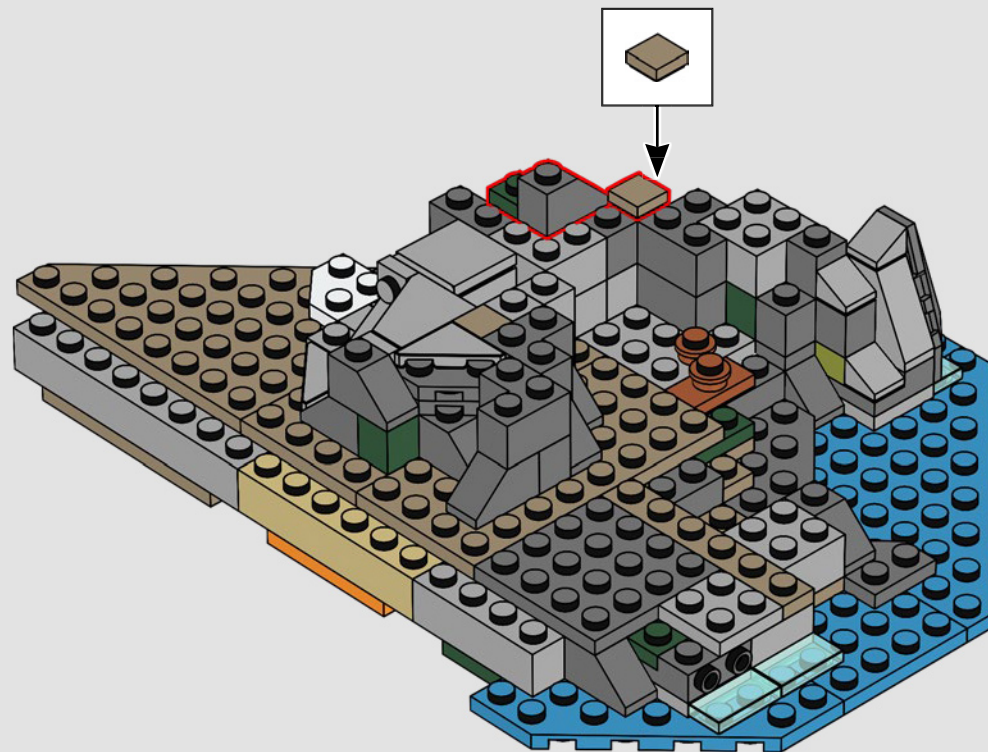

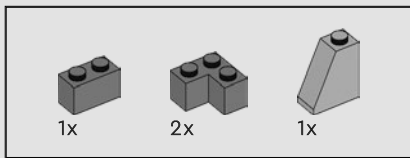

287

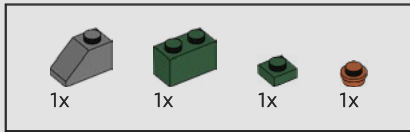

288

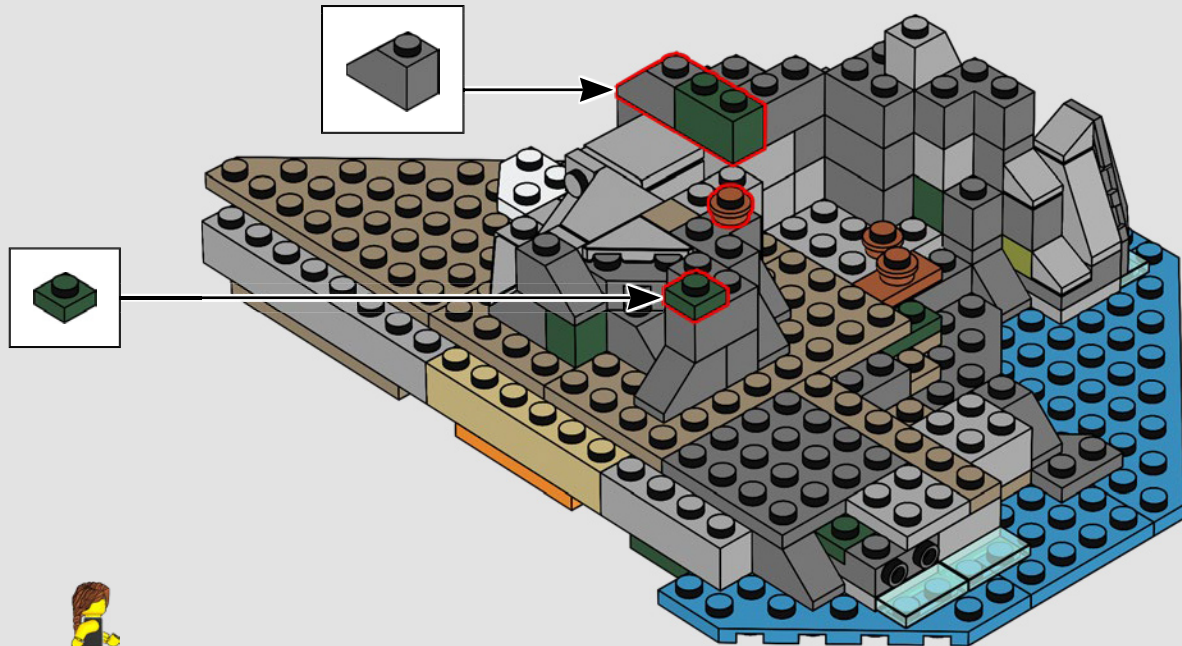

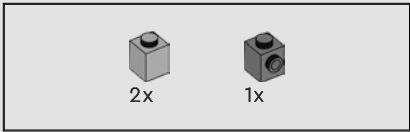

289

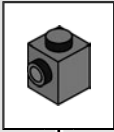

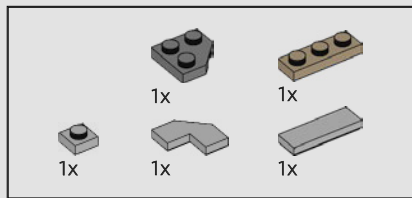

290

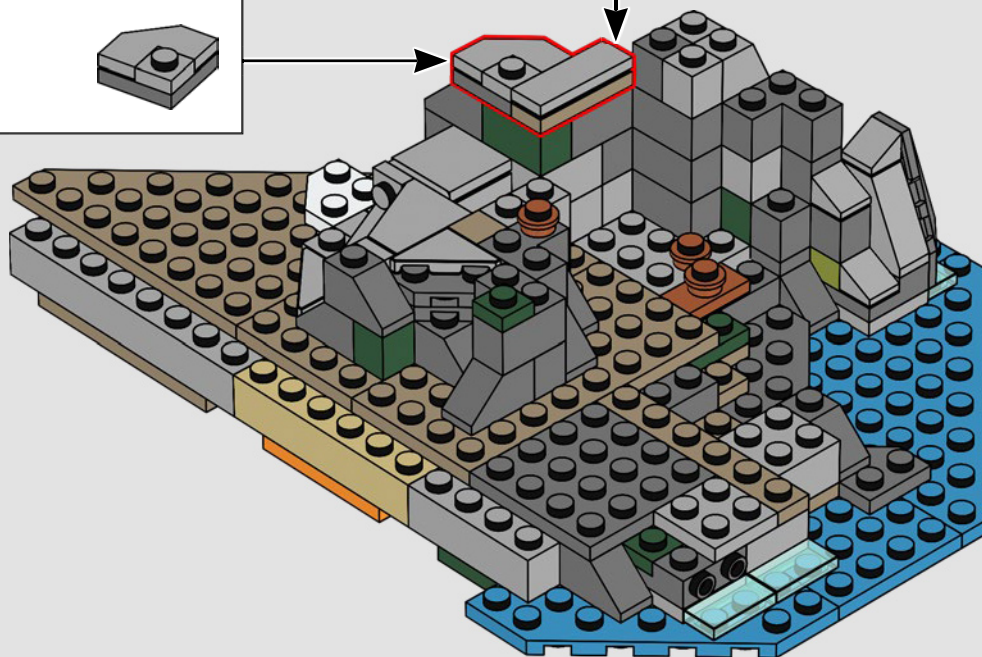
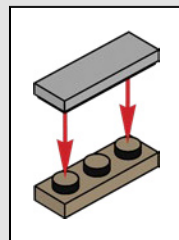
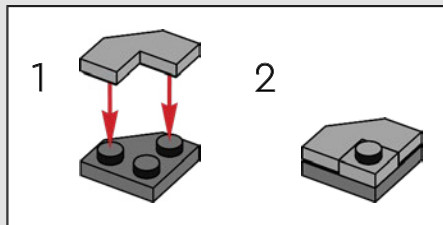

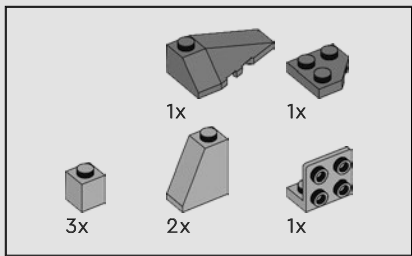

291

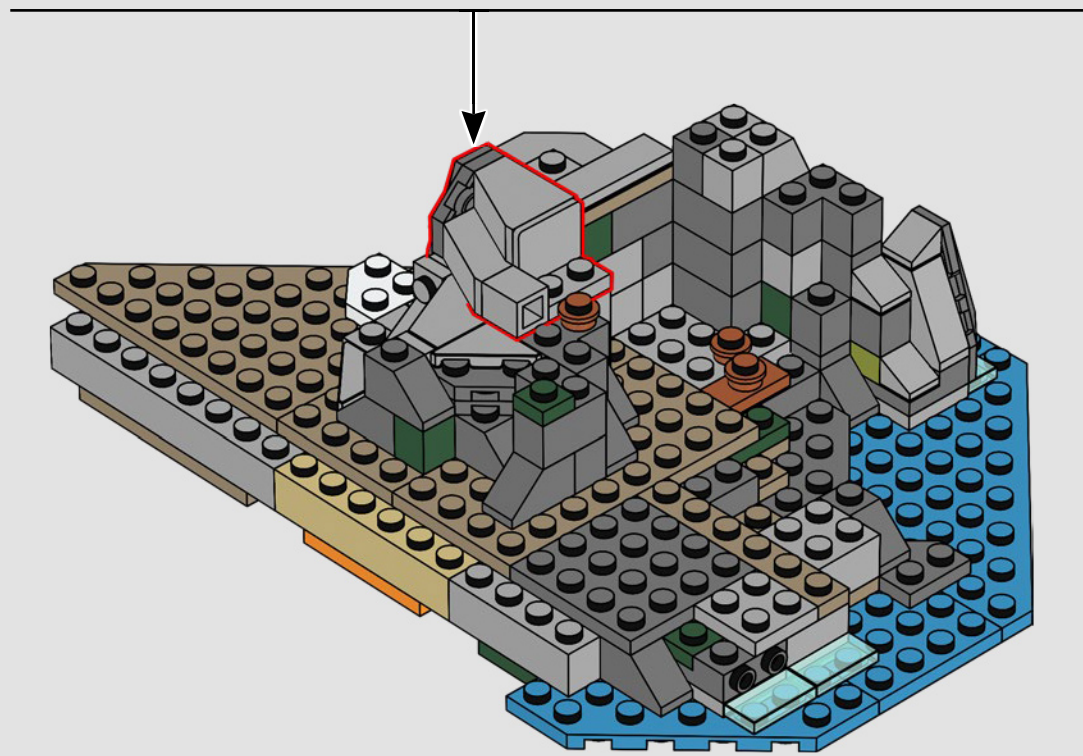
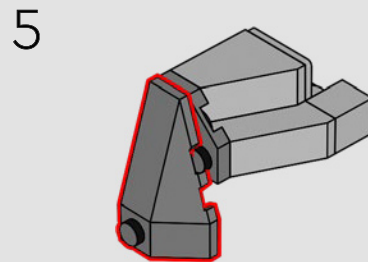
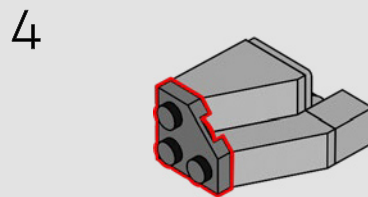
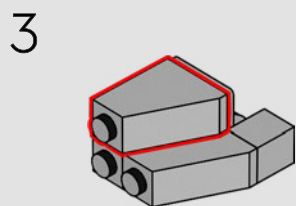
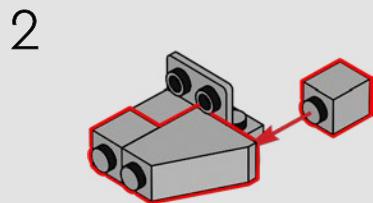
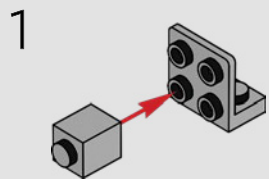

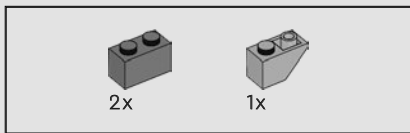

292

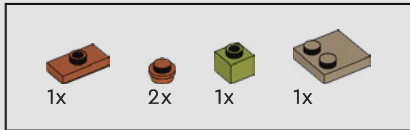
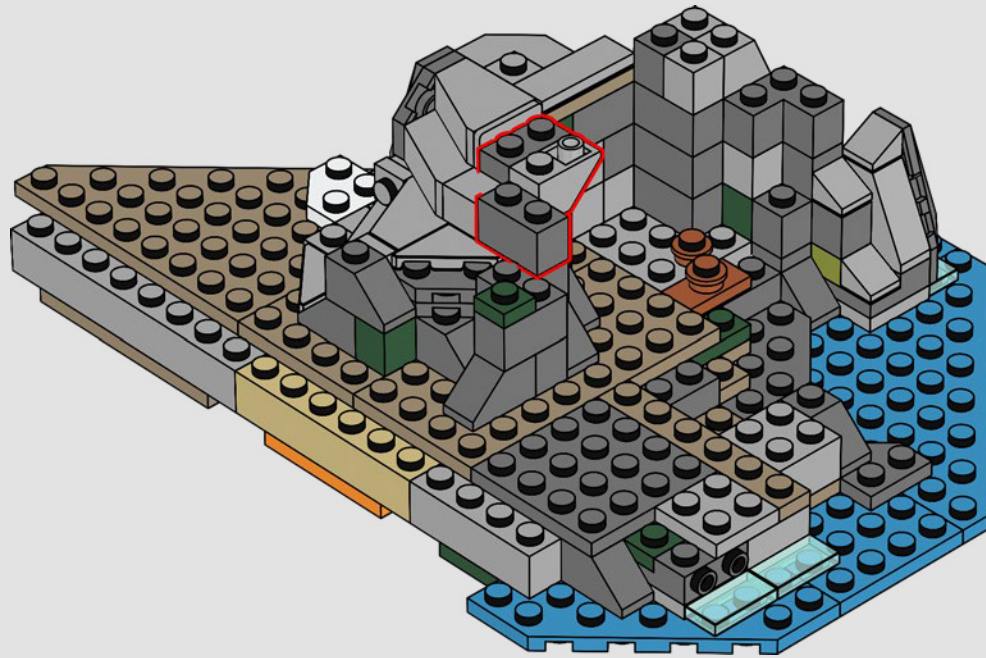

293

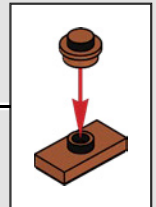

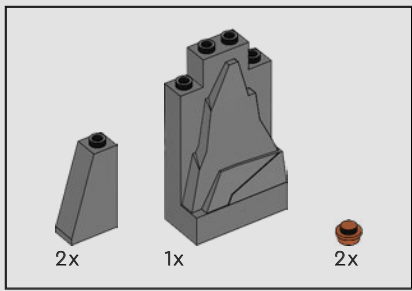

294

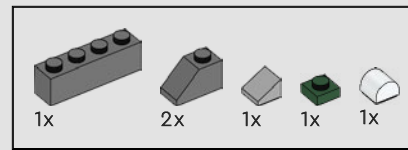
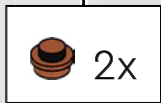
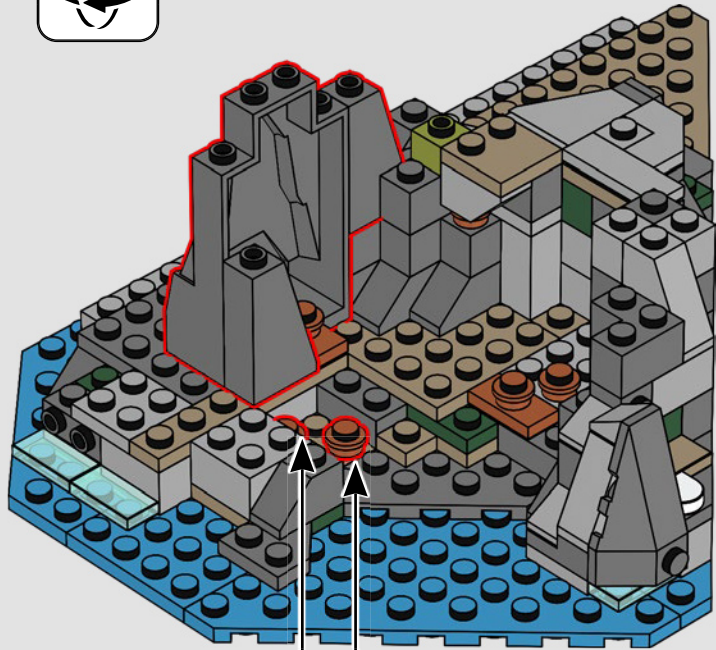

295

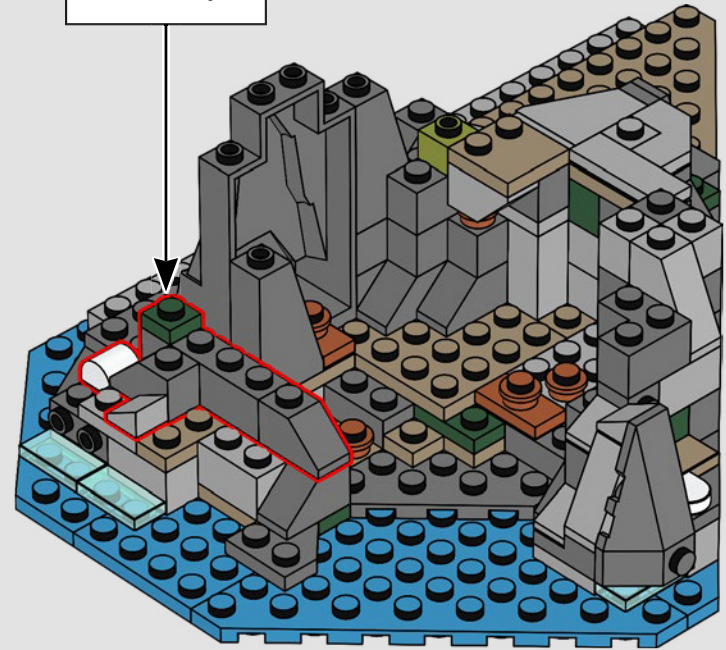
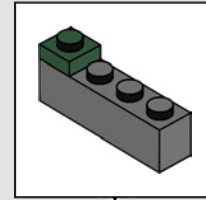

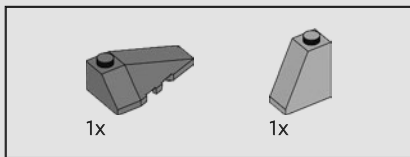

296

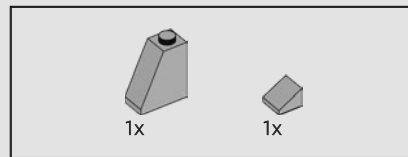
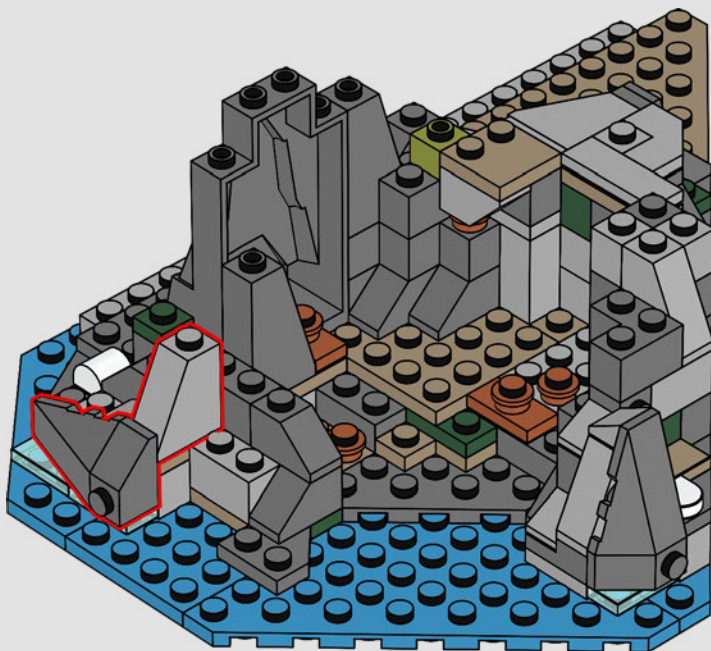

297

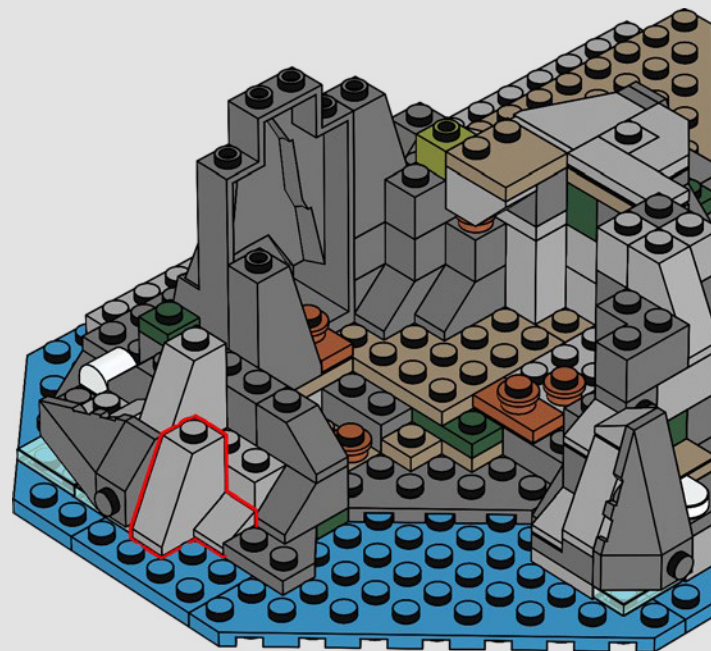

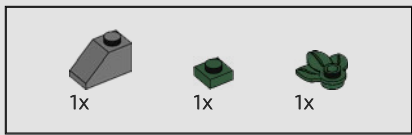

298

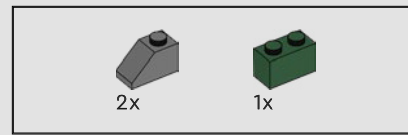
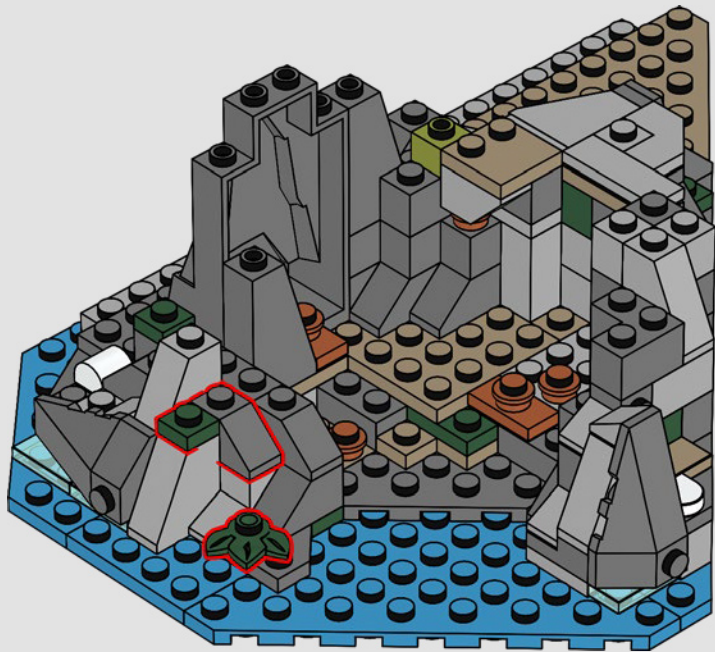

299



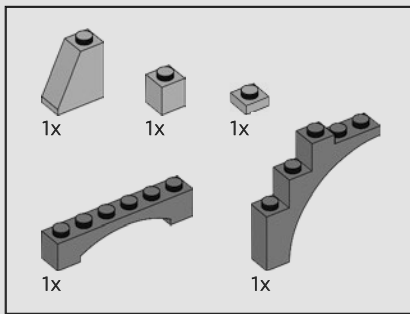

300

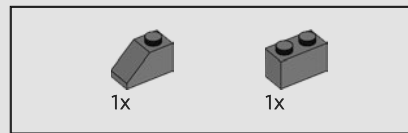
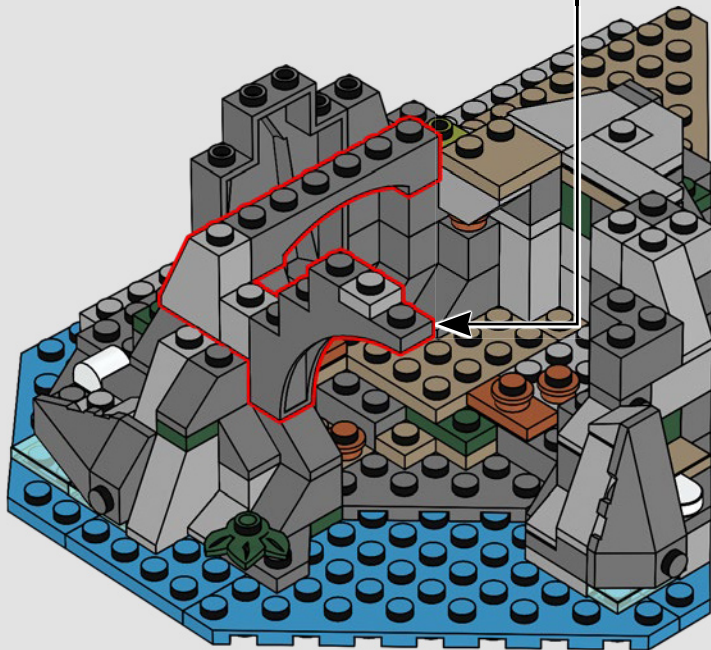
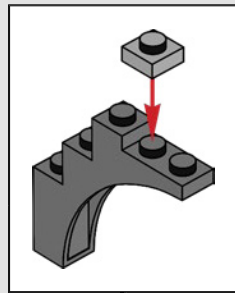

301

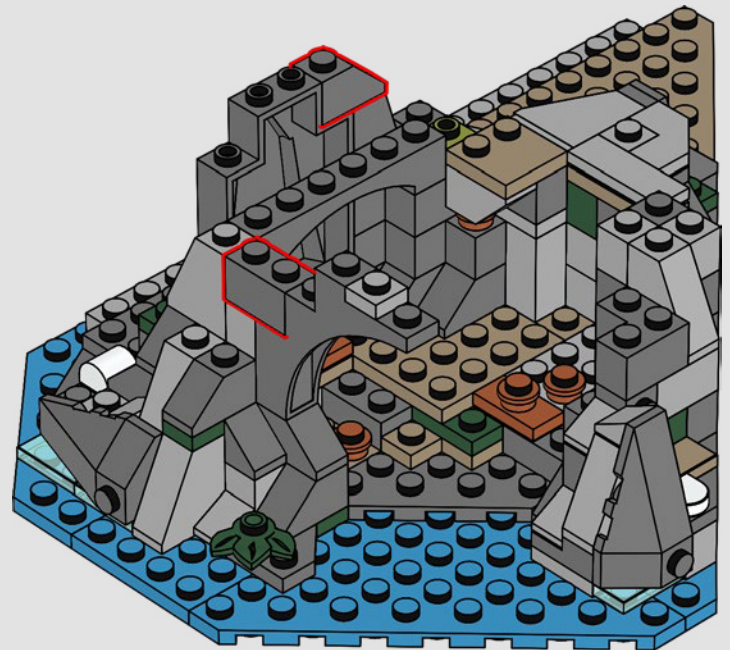

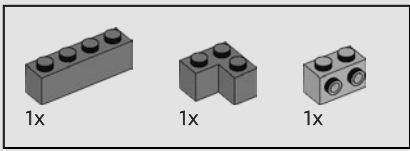

302

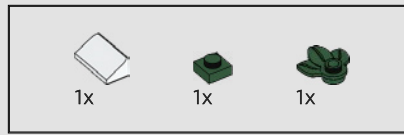
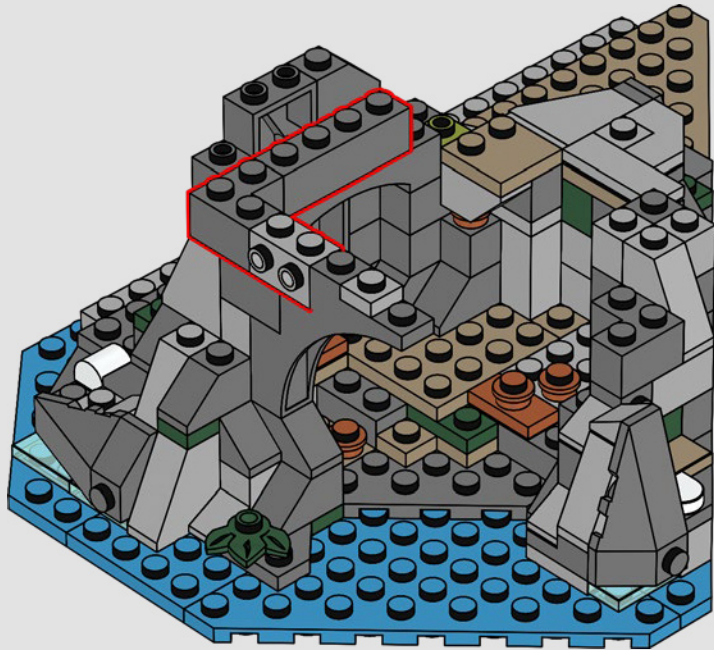

303

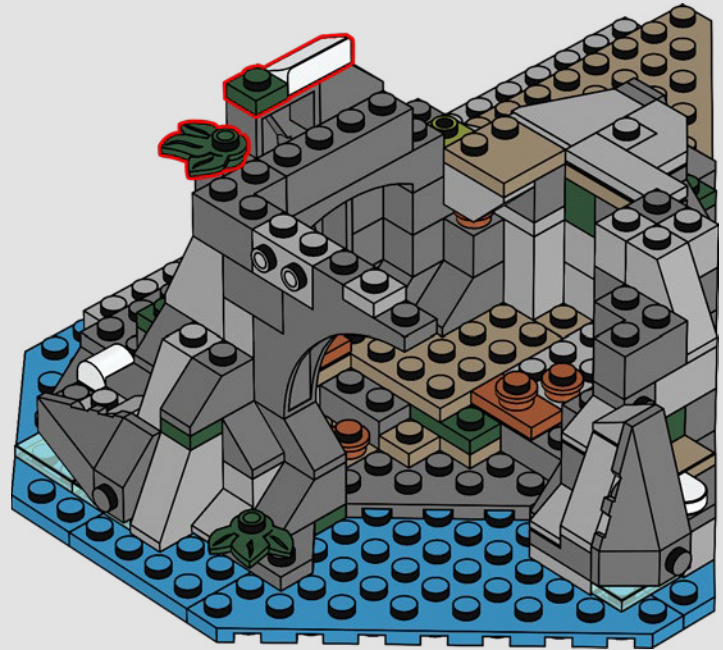

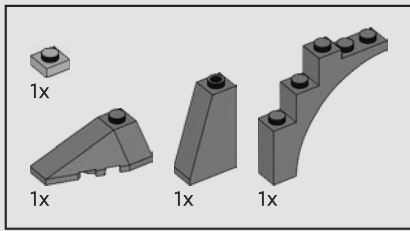

304

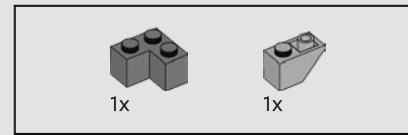
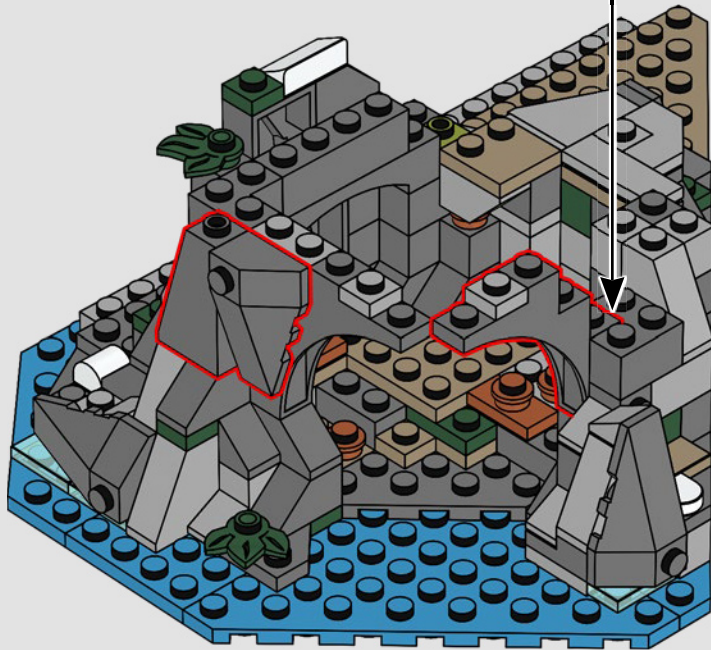
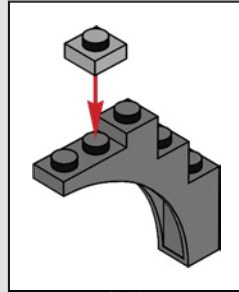

305

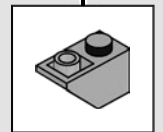
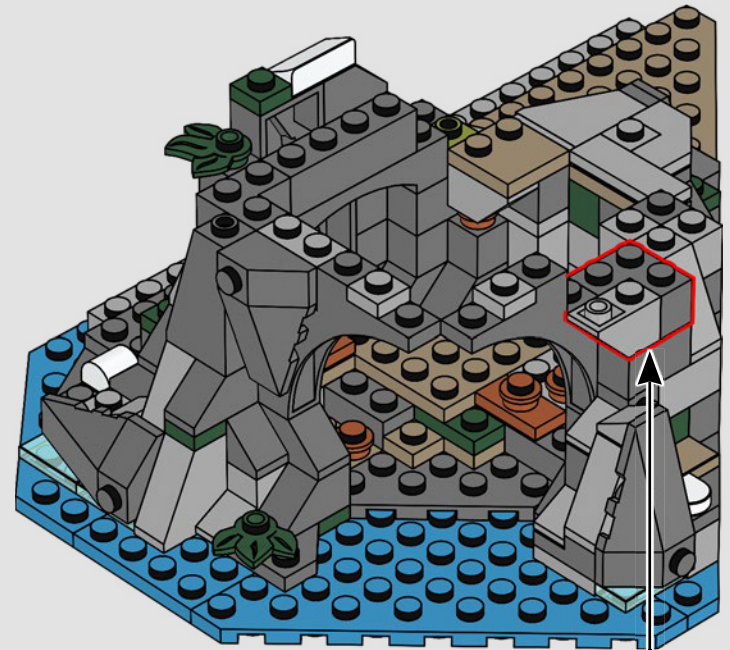

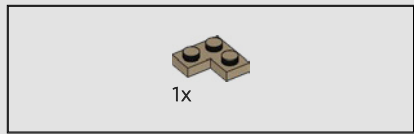

306

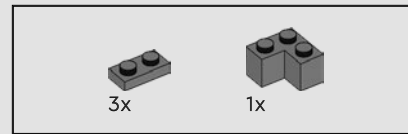

307

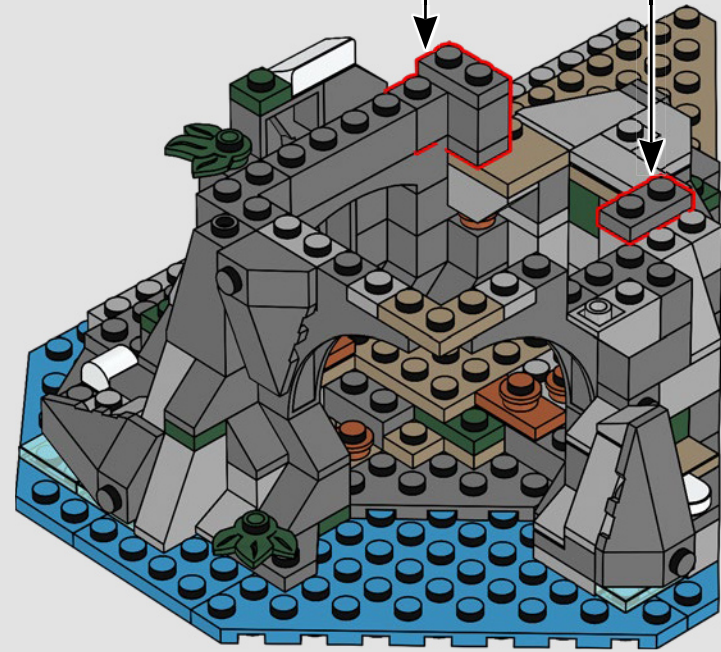
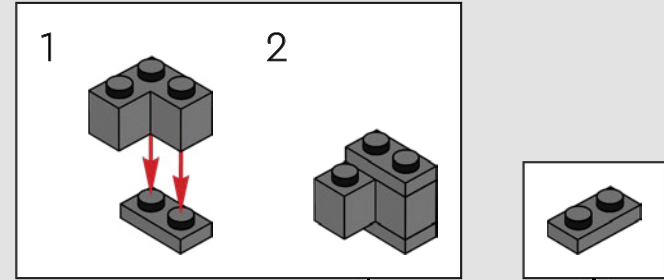

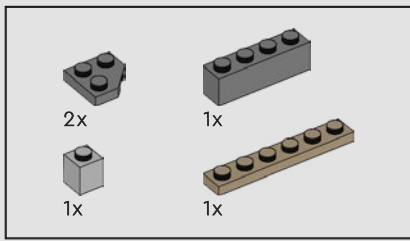

308

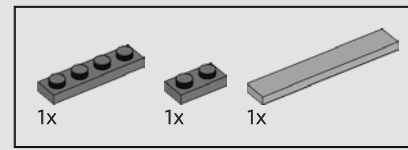
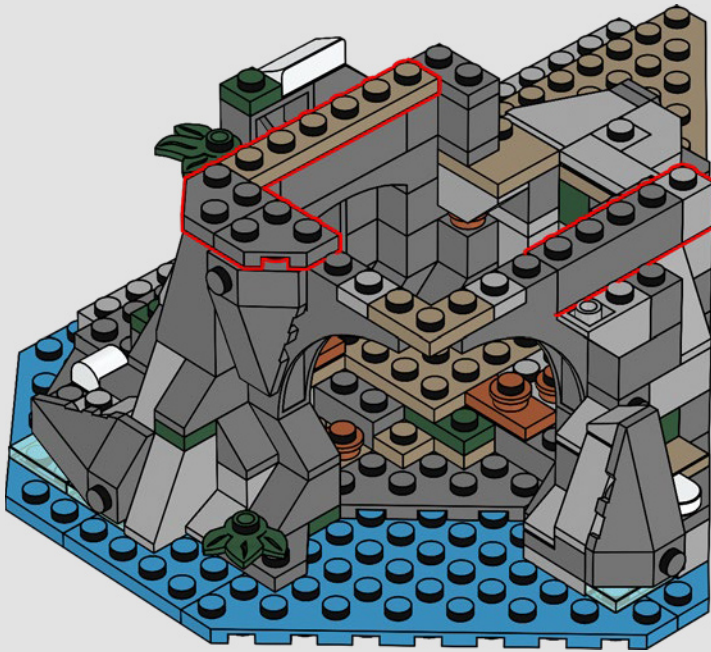

309

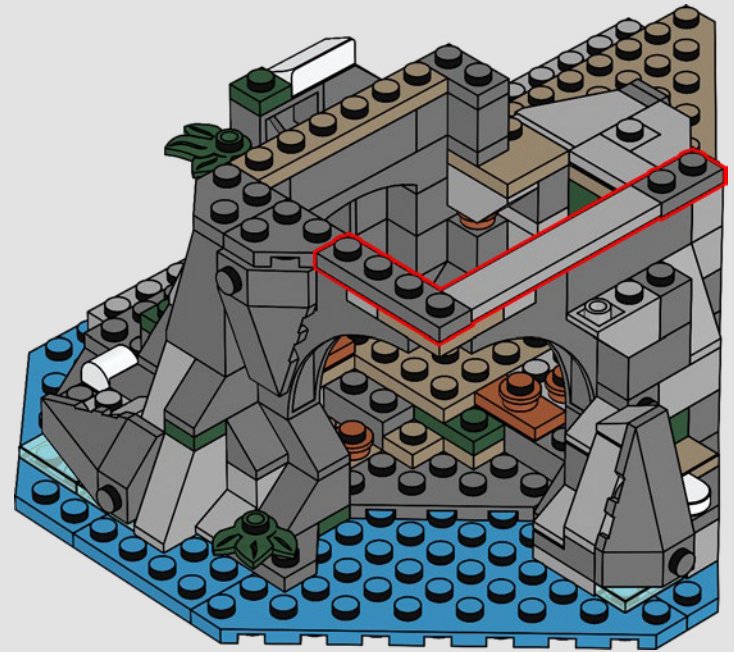

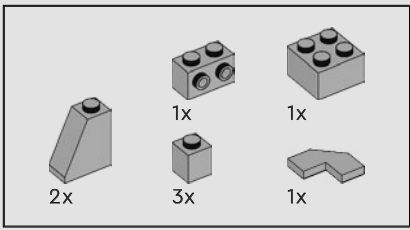

310

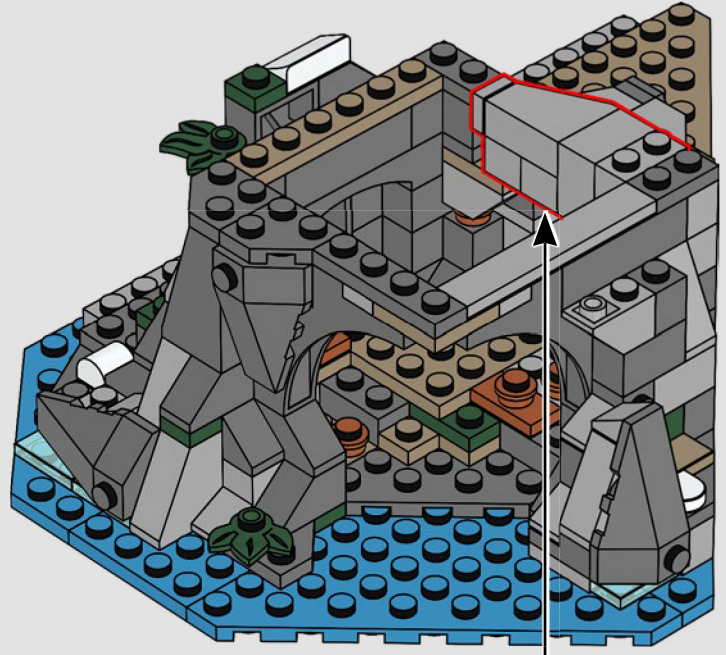
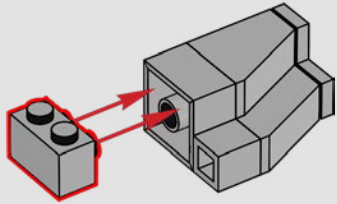
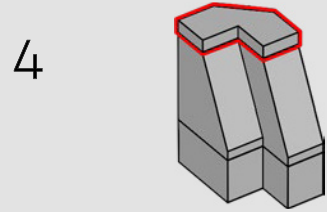
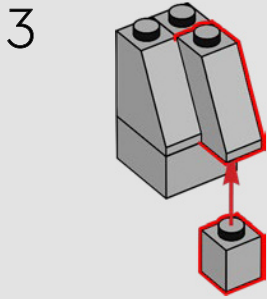
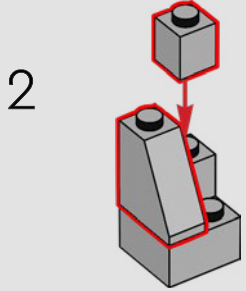
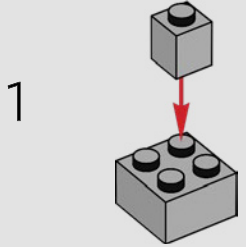

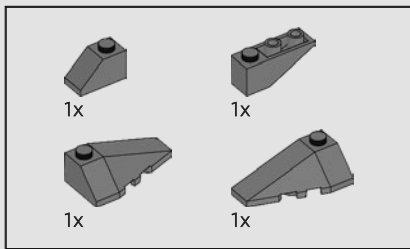

311

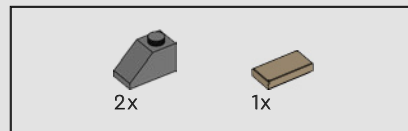
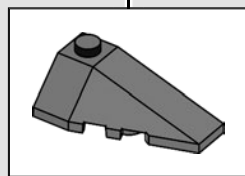
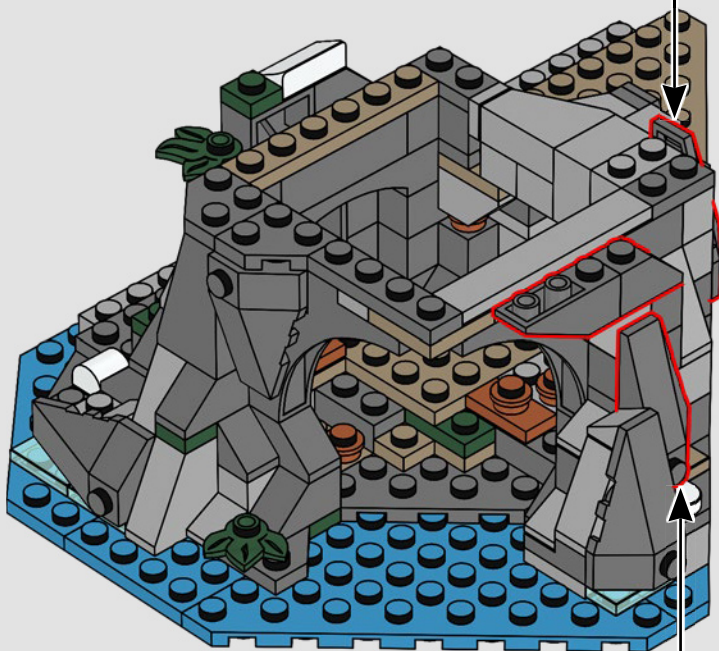
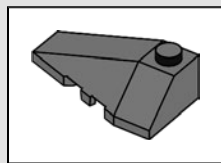

312





313

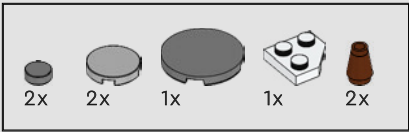

314

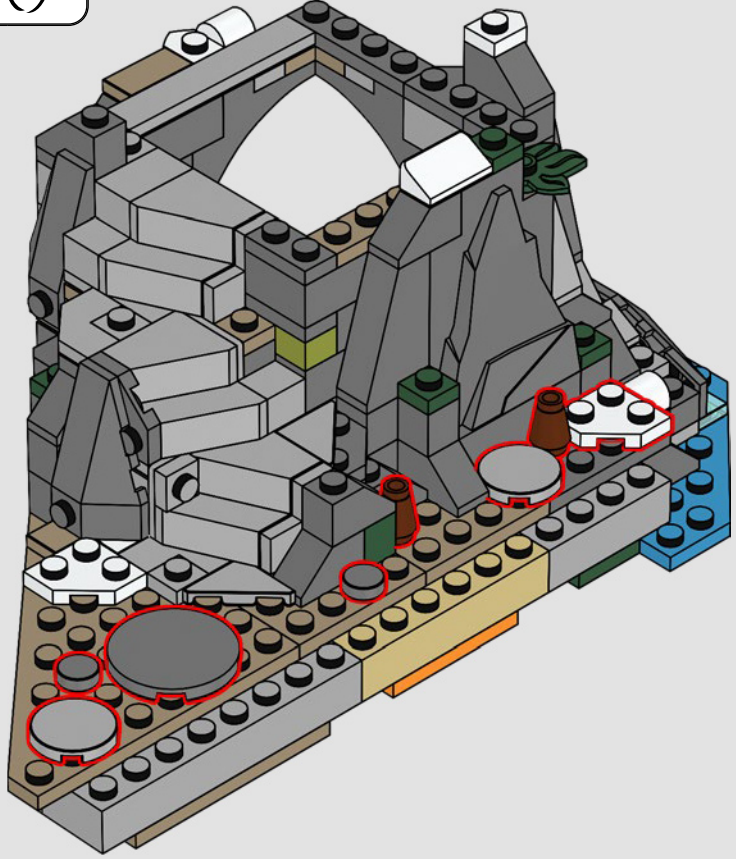



315

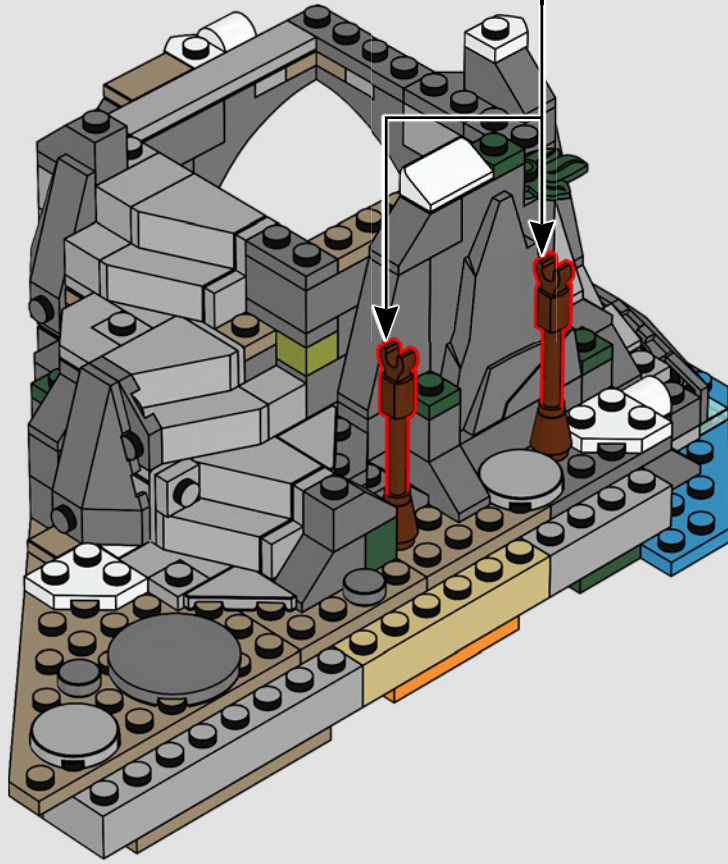
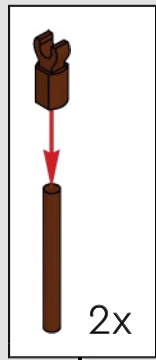

316

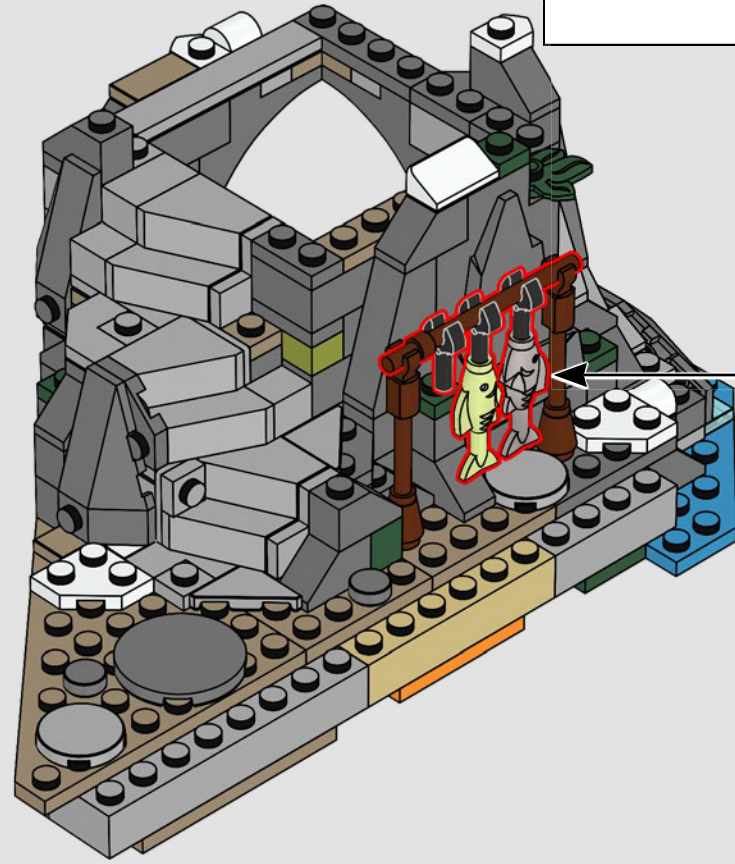
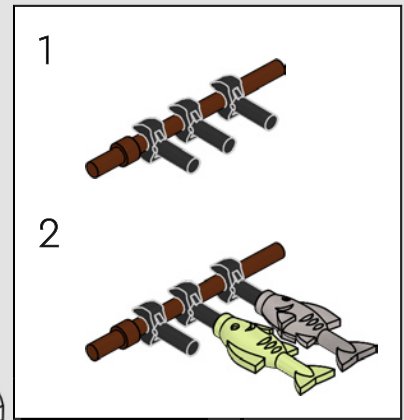

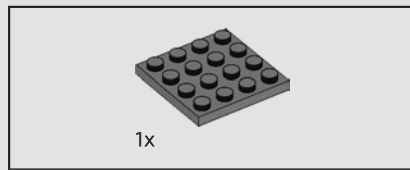

317

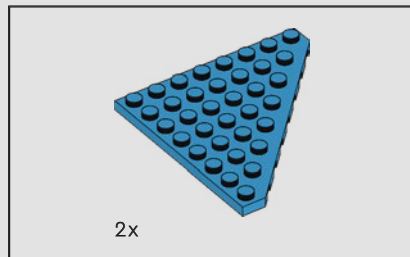
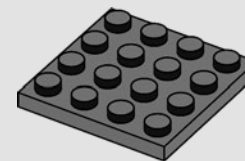

318

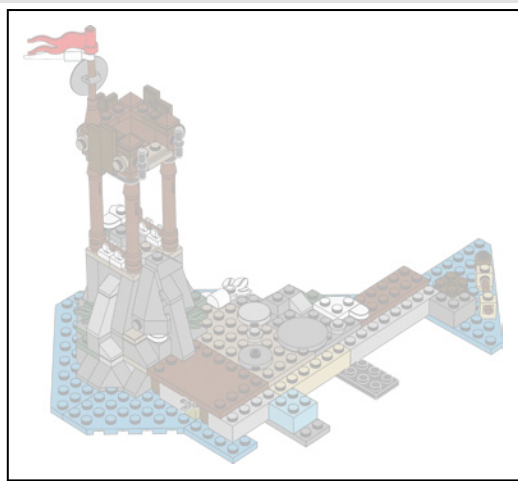
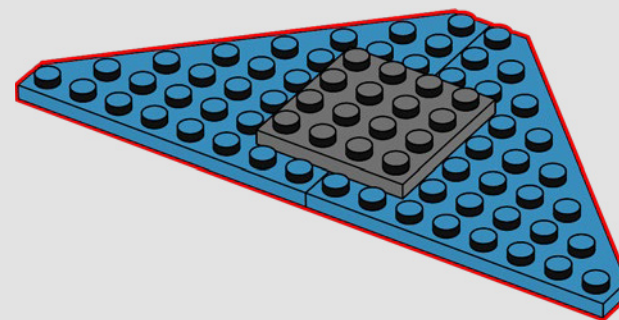

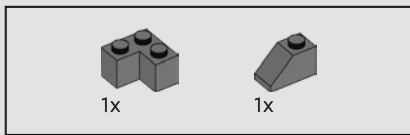

319

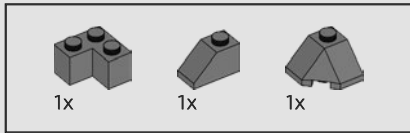
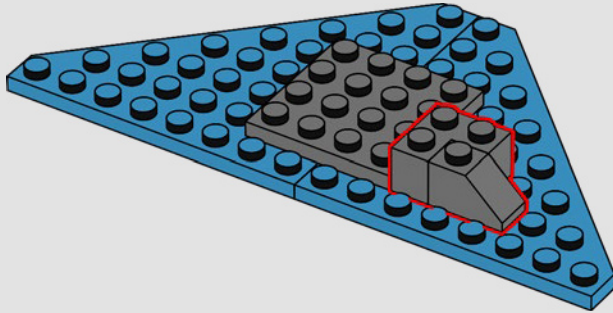

320

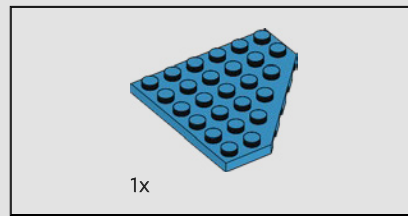
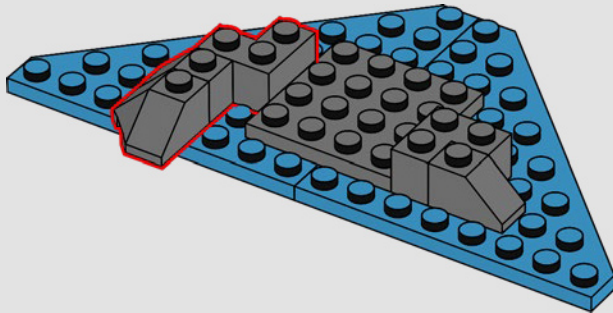

321

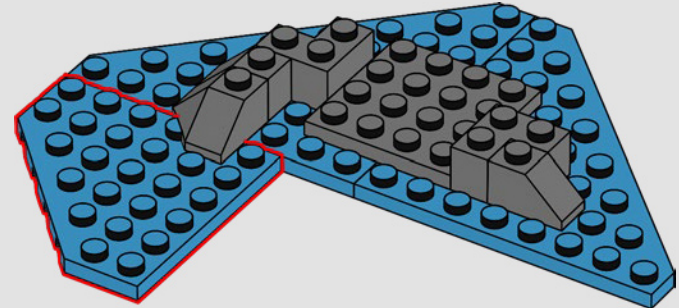

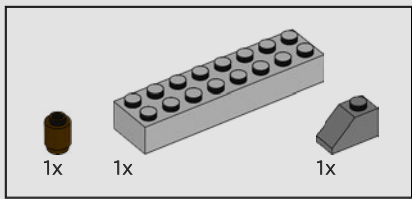

322

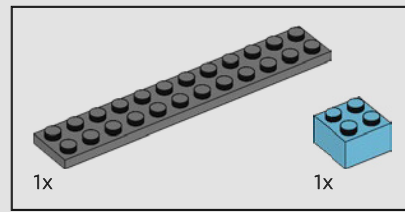
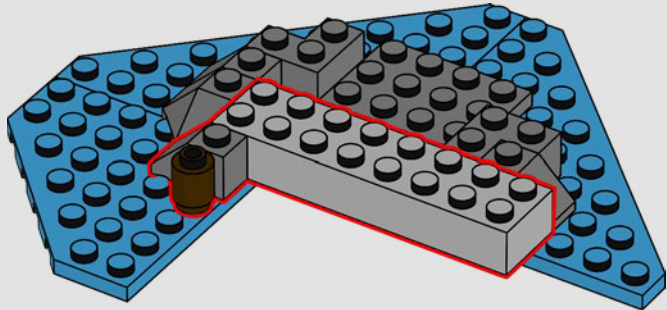

323

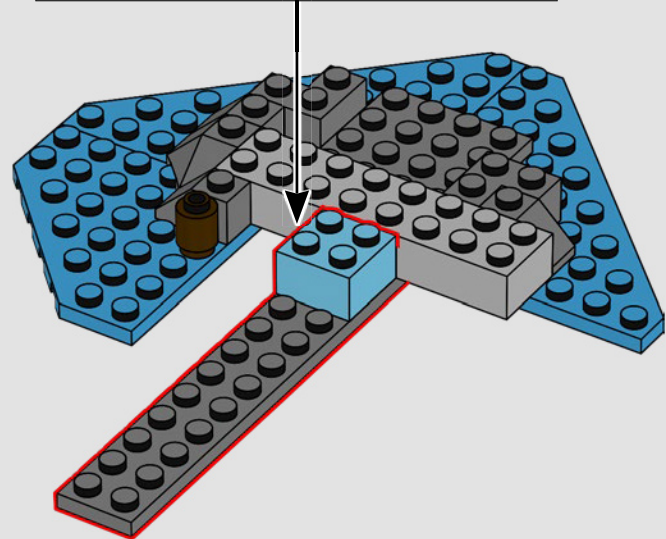
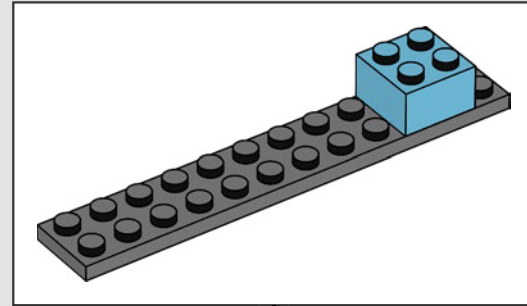

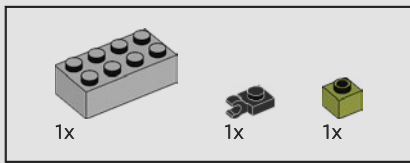

324

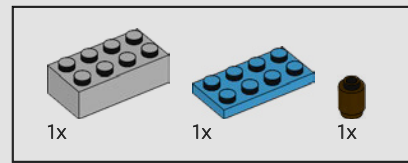
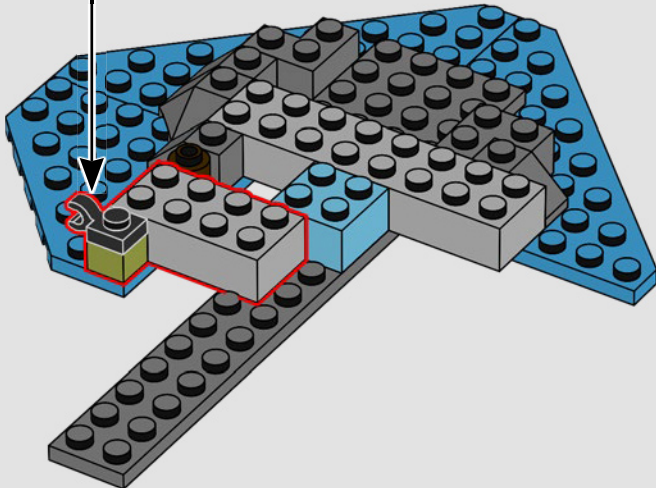
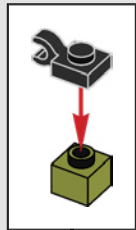

325

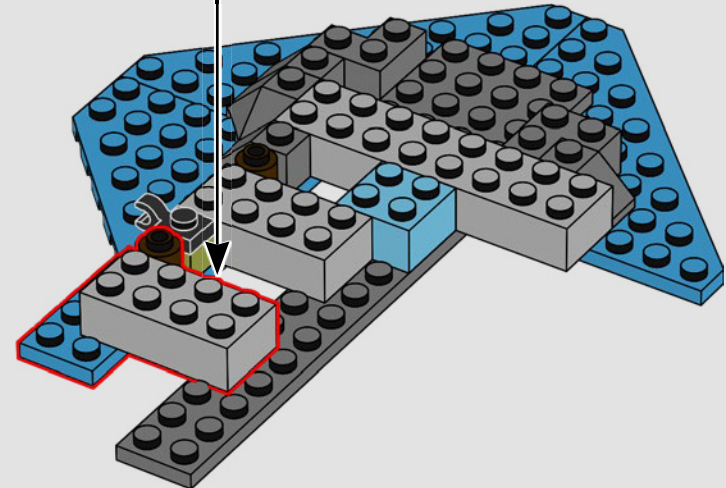
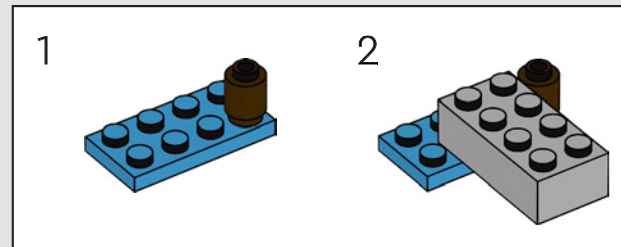

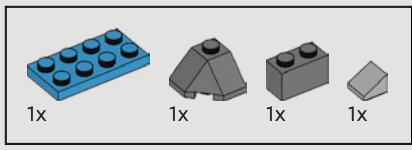

326

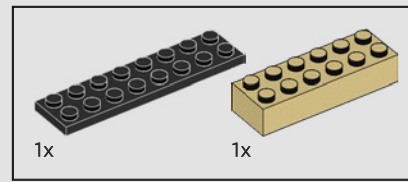
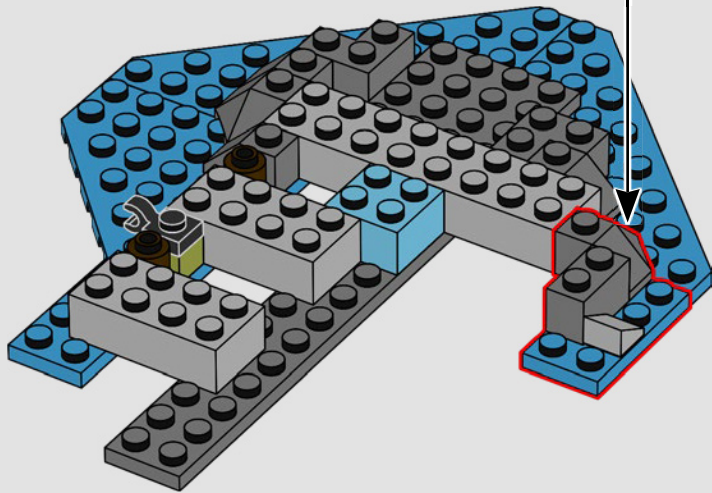
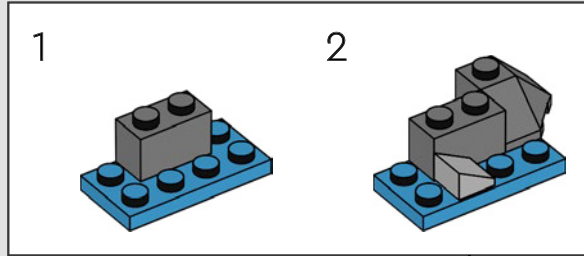

327

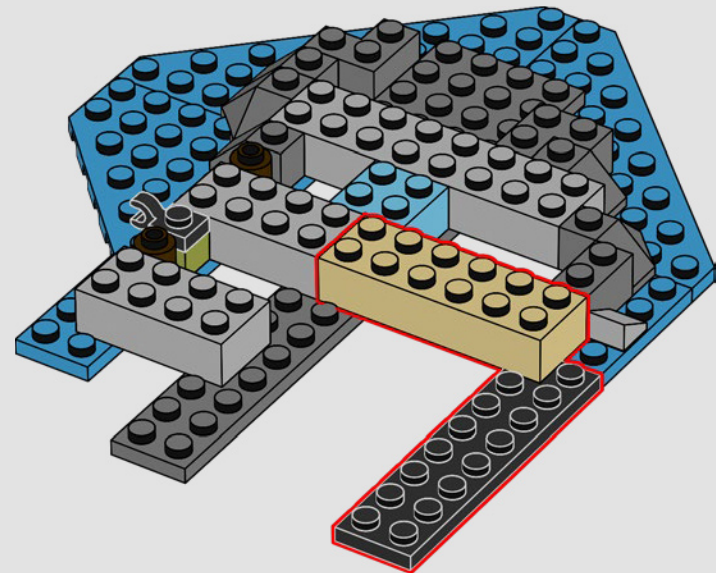

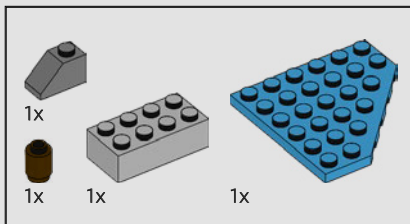

328

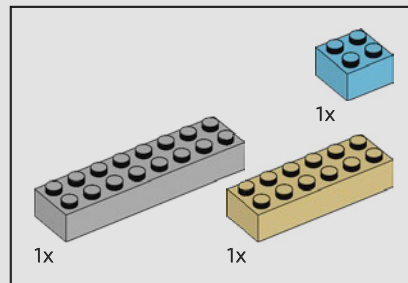
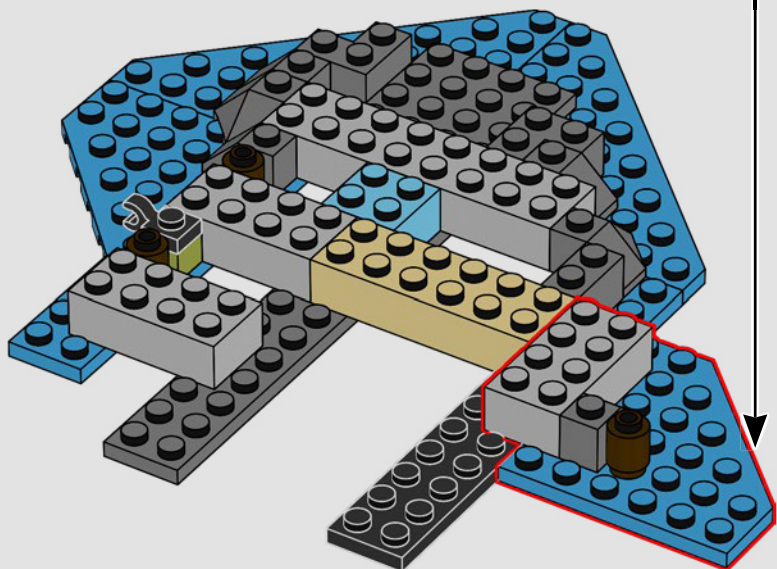
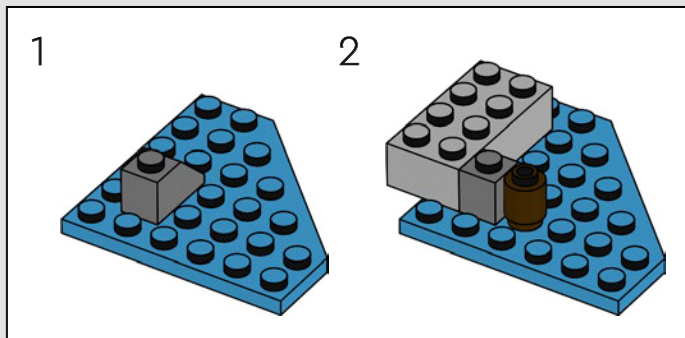

329

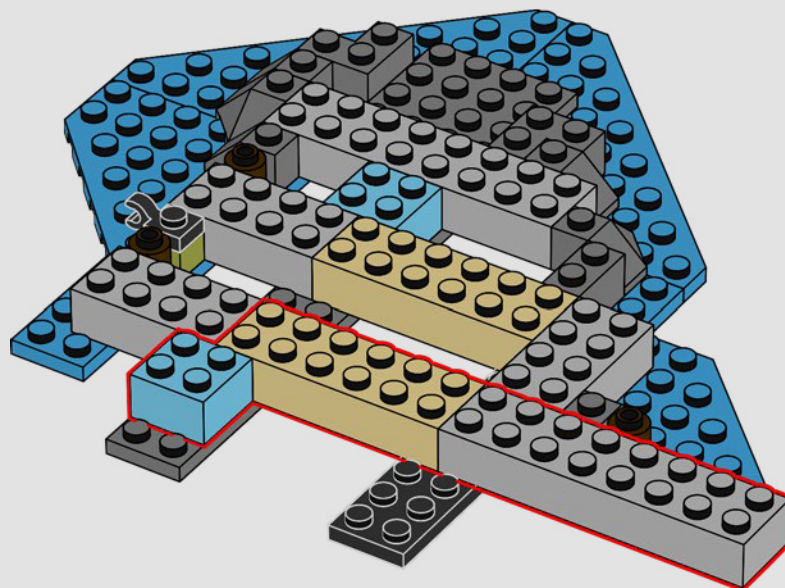

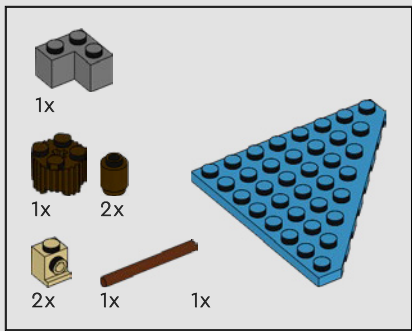

330

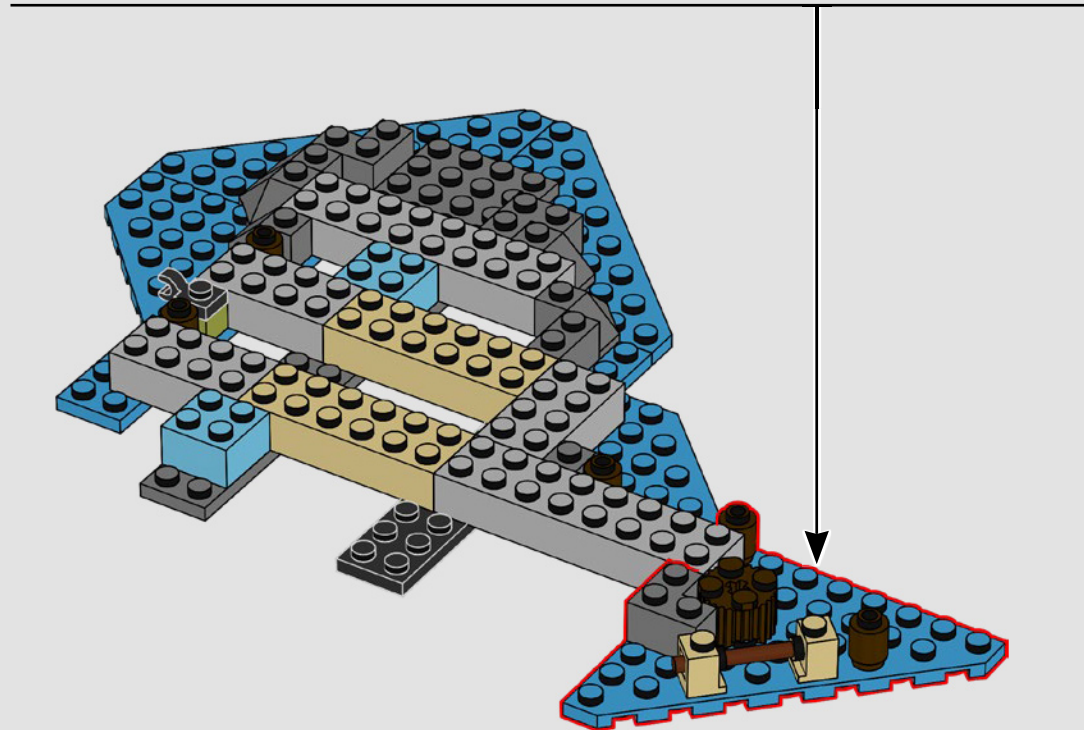
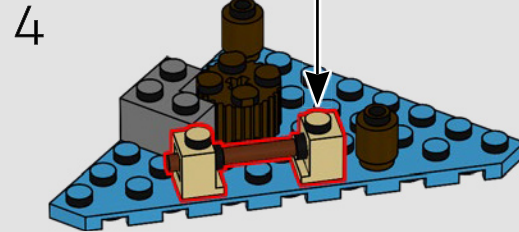
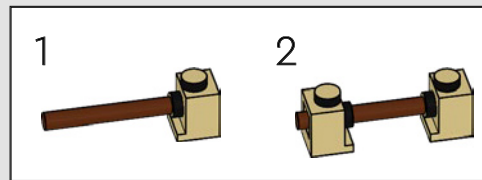
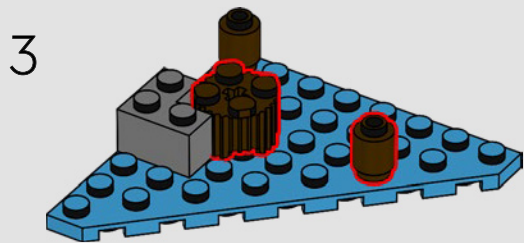
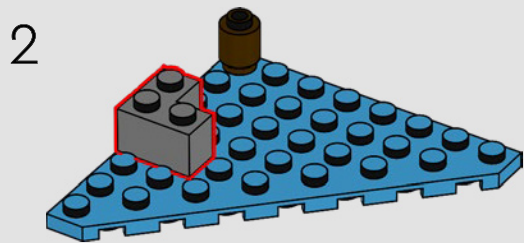
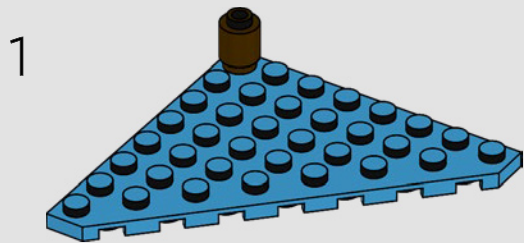

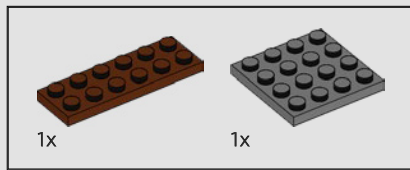

331

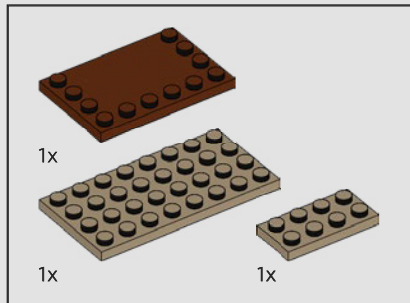
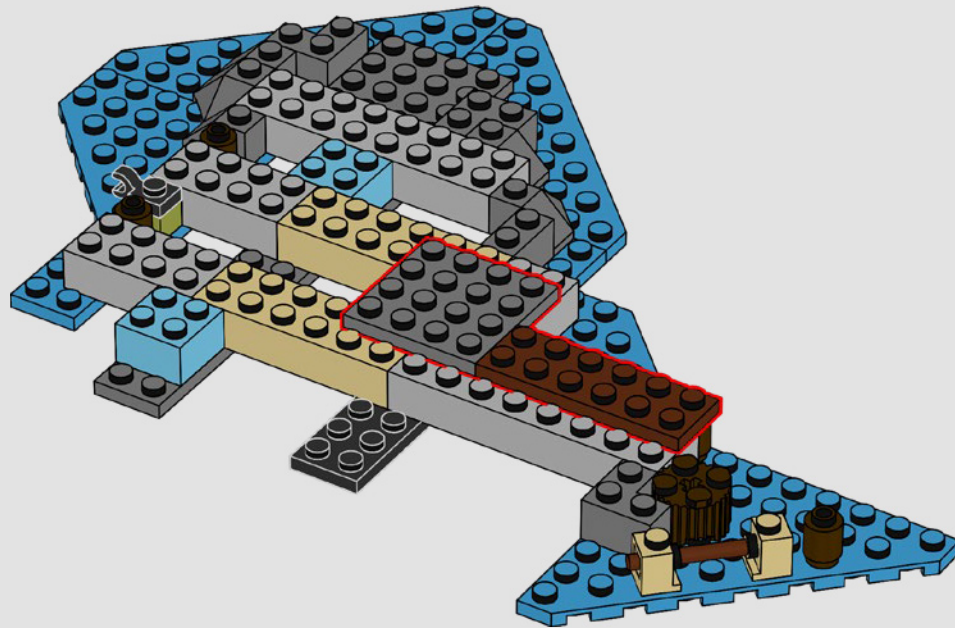

332

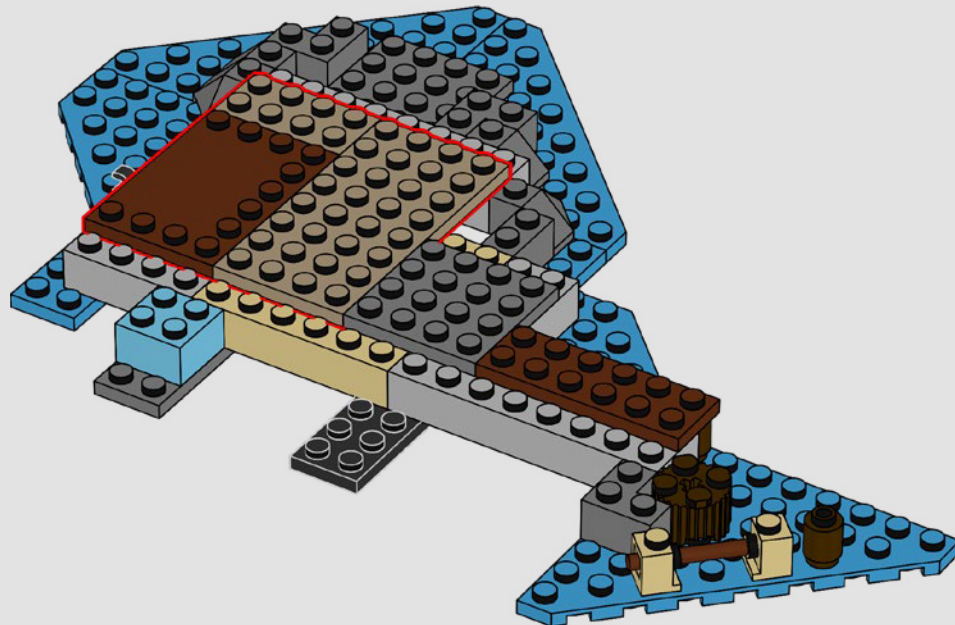

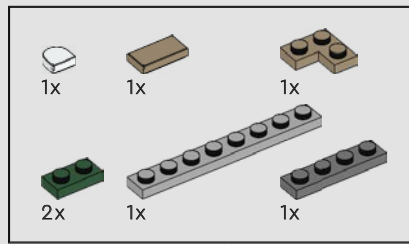

333

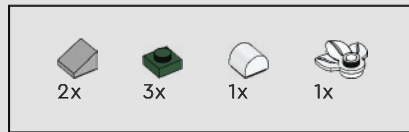
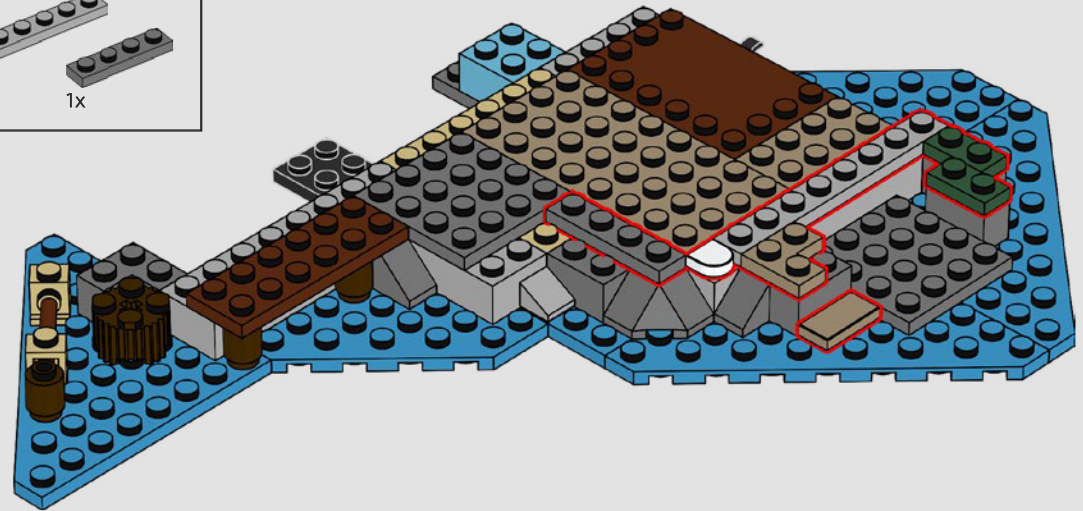
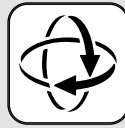

334

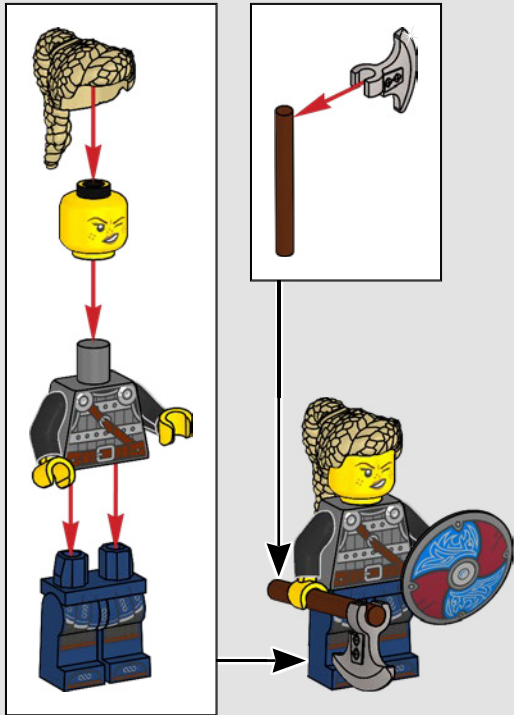
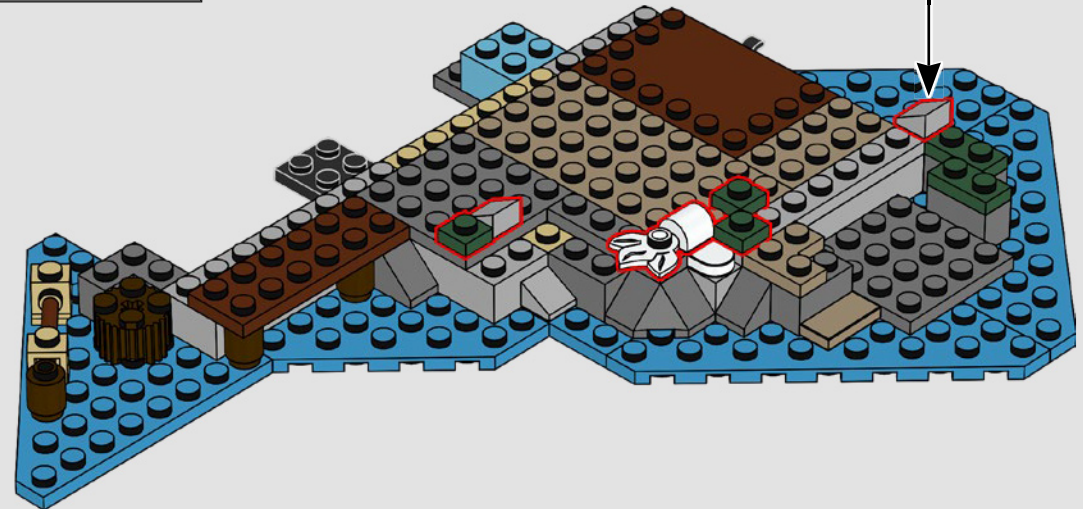
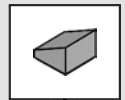

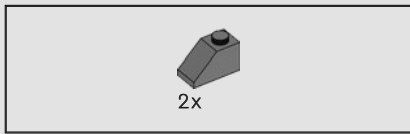

335

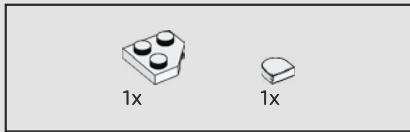
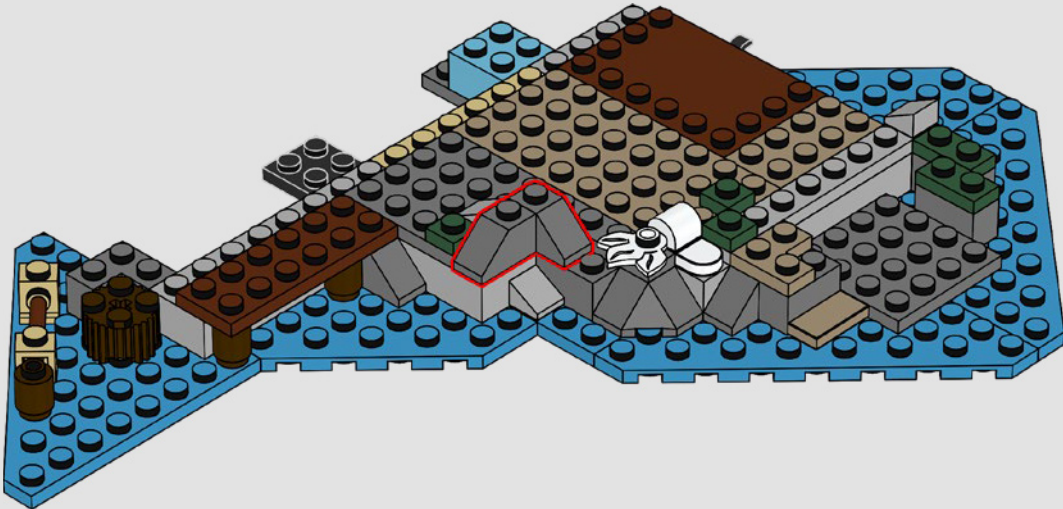

336

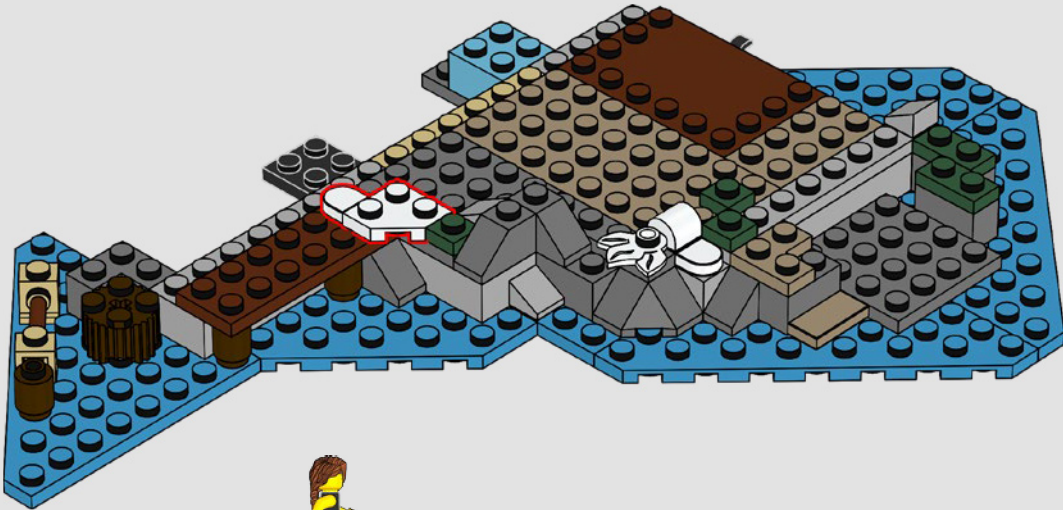

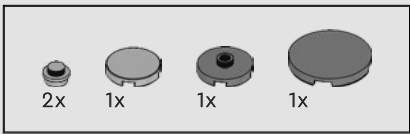

337

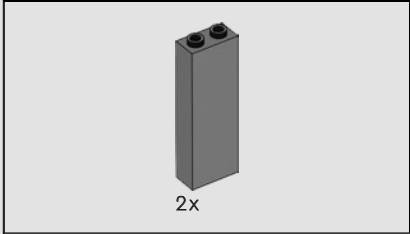

338



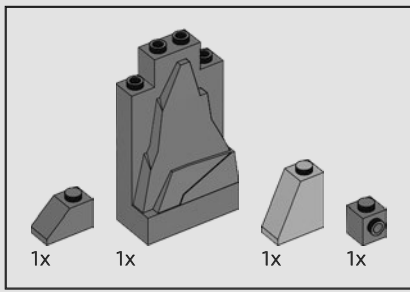

339

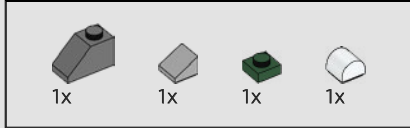

340

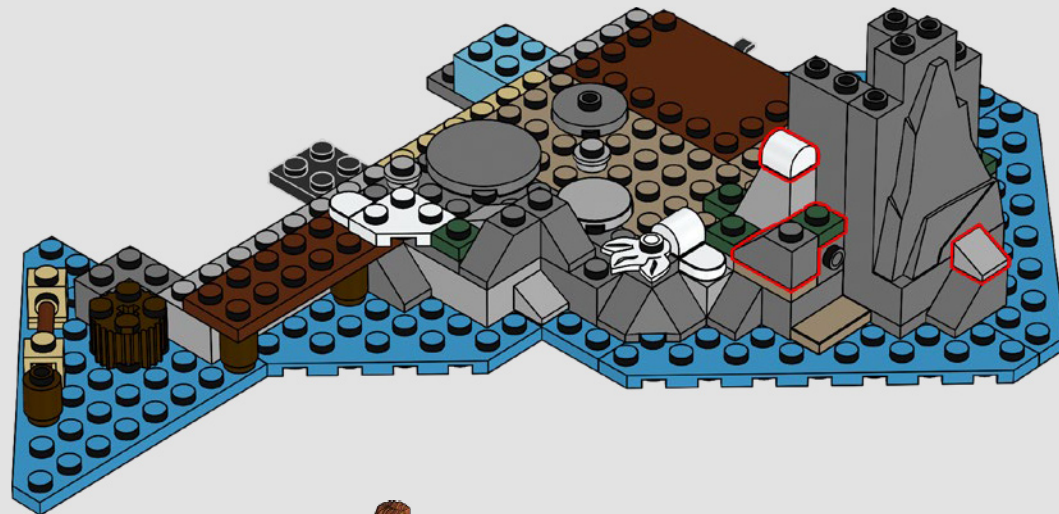

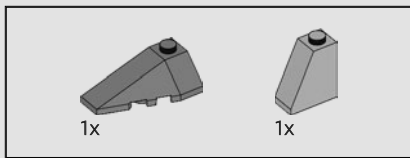

341

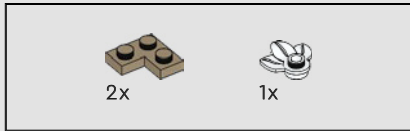

342



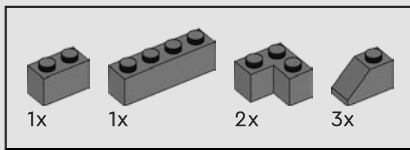

343

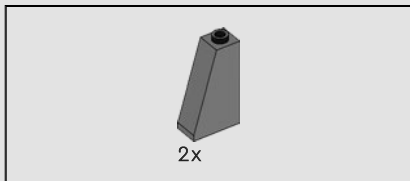
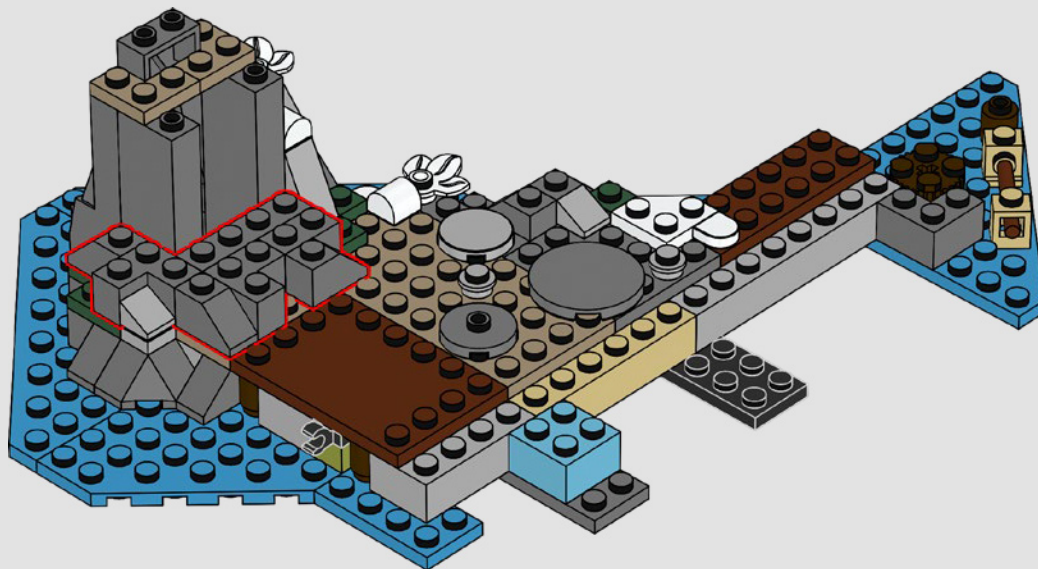

344



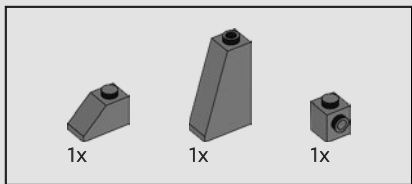

345

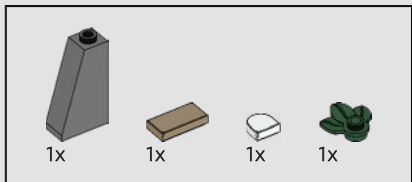
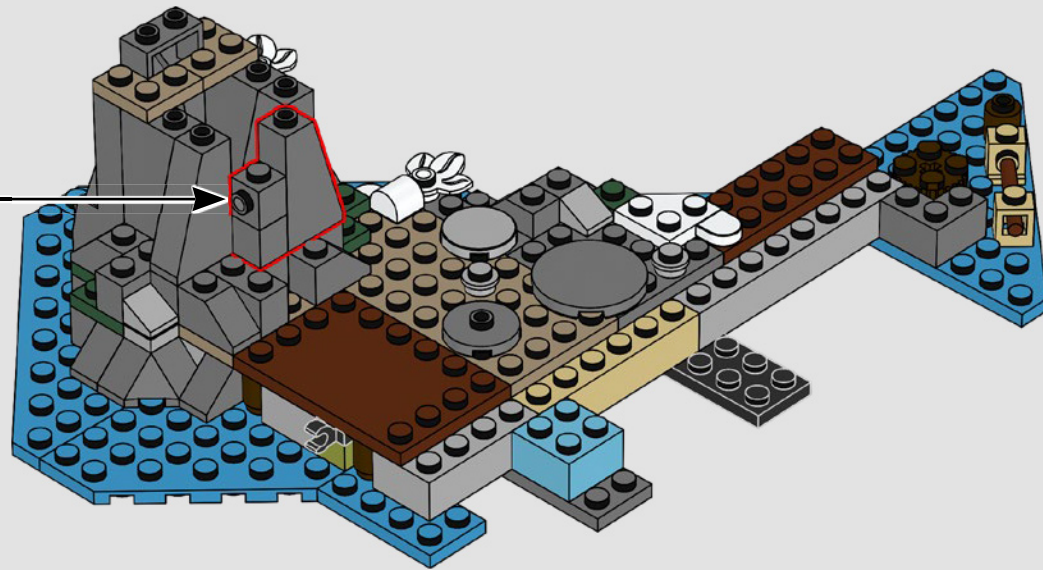
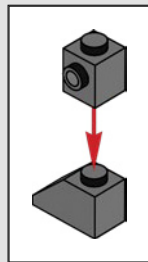

346

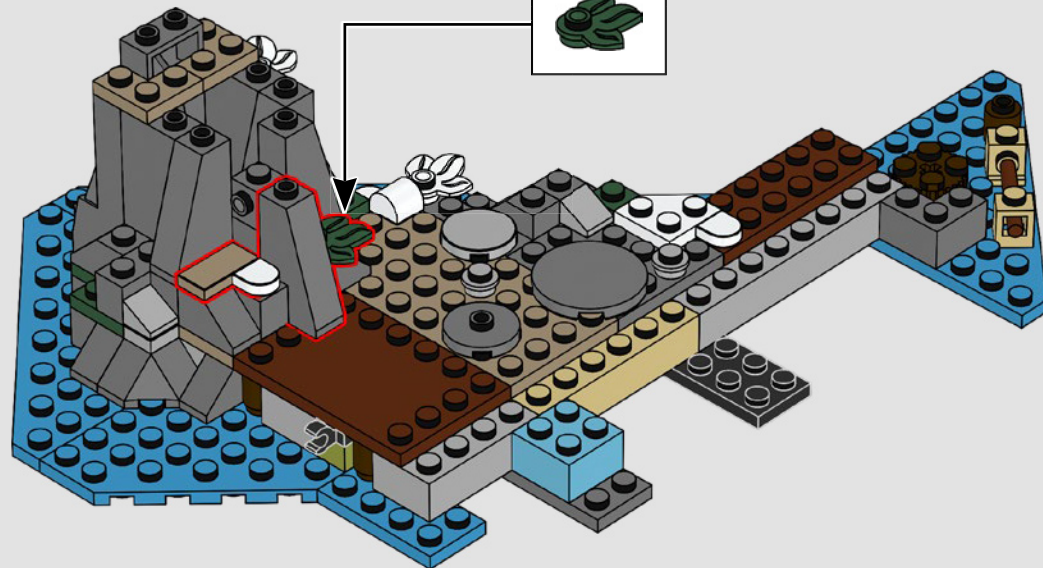

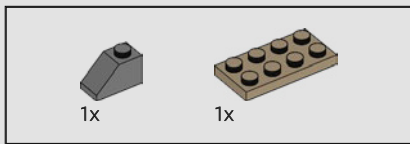

347

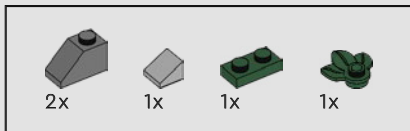

348

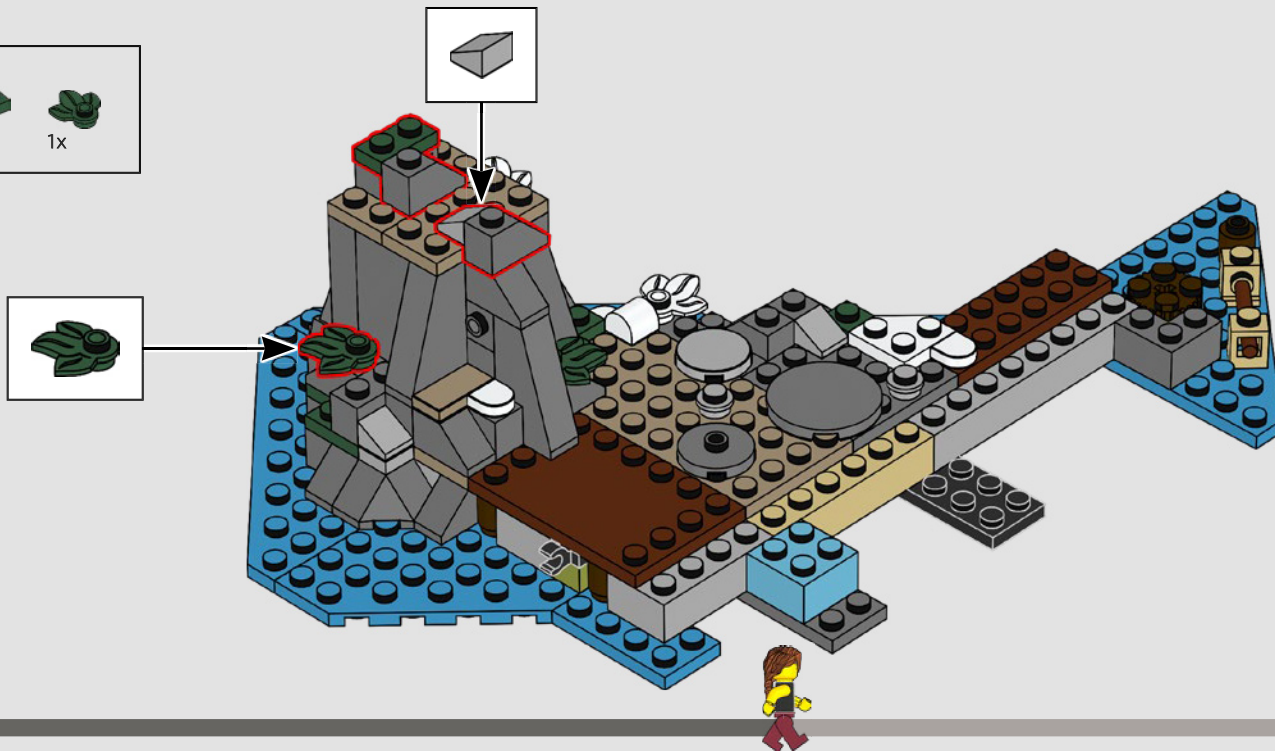

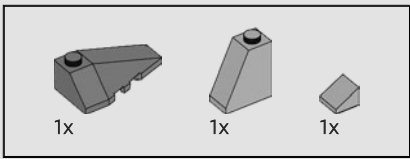

349

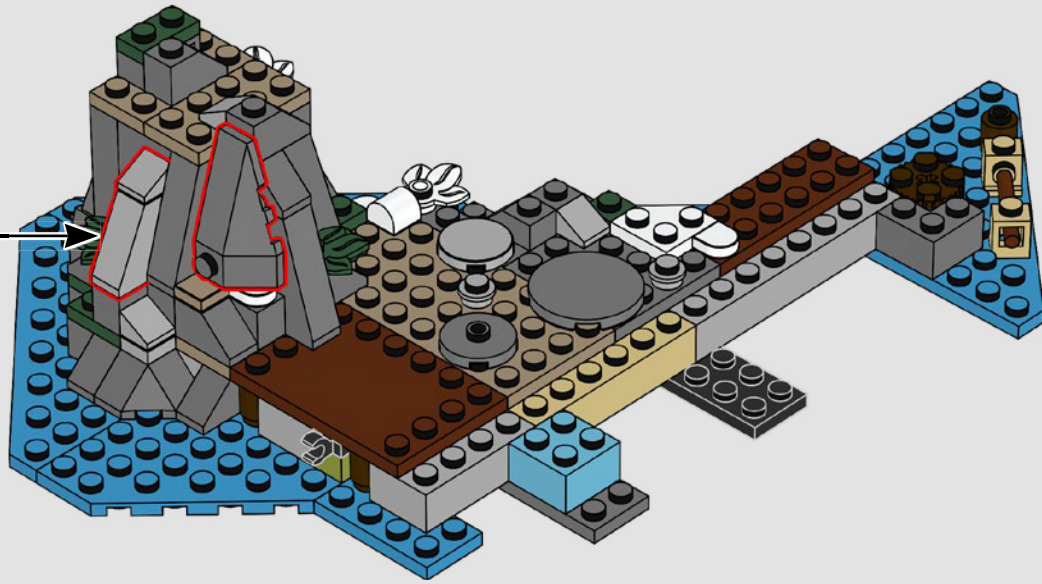
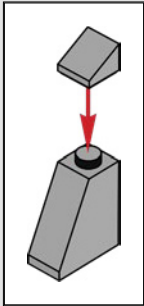

350

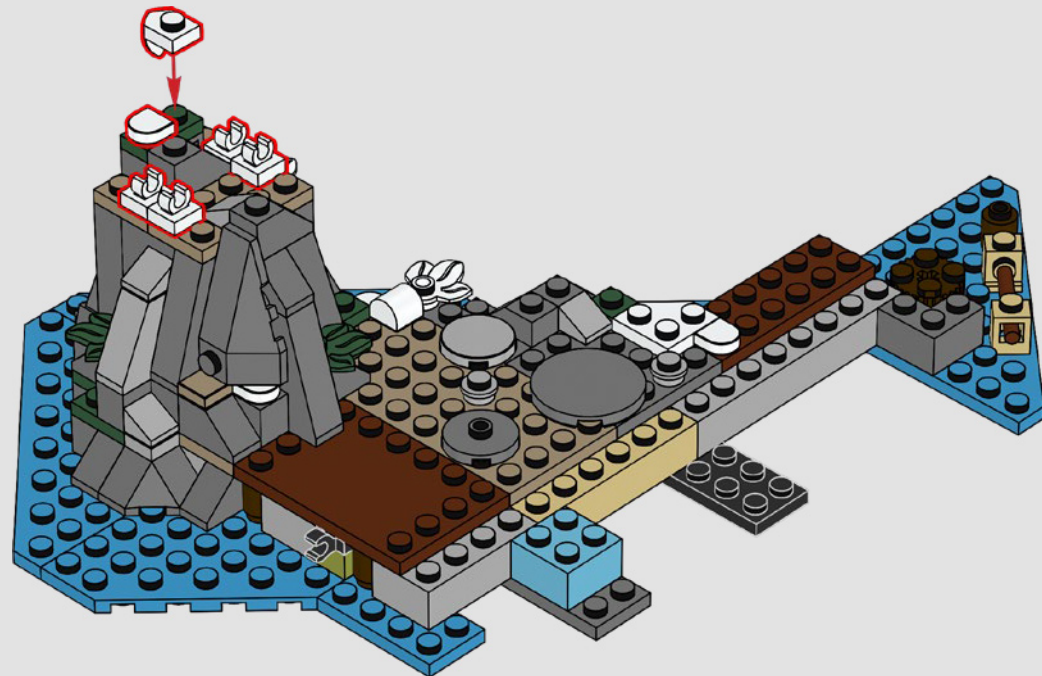

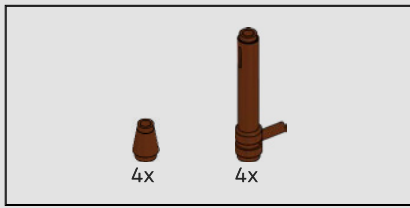

351

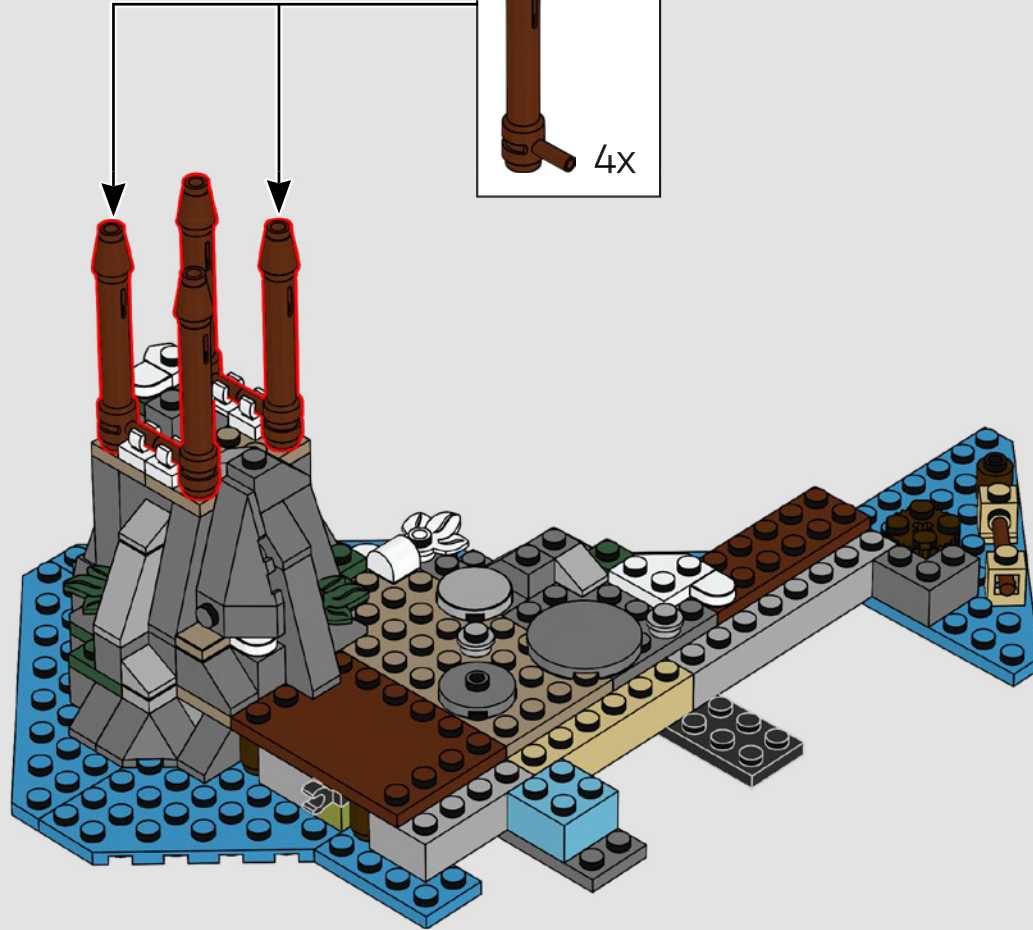
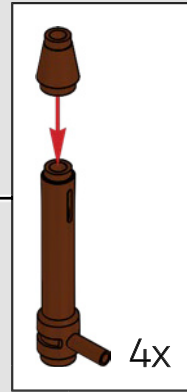

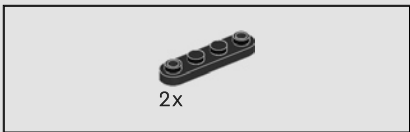

352

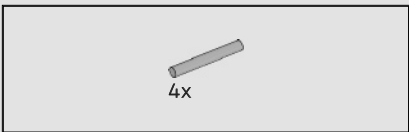
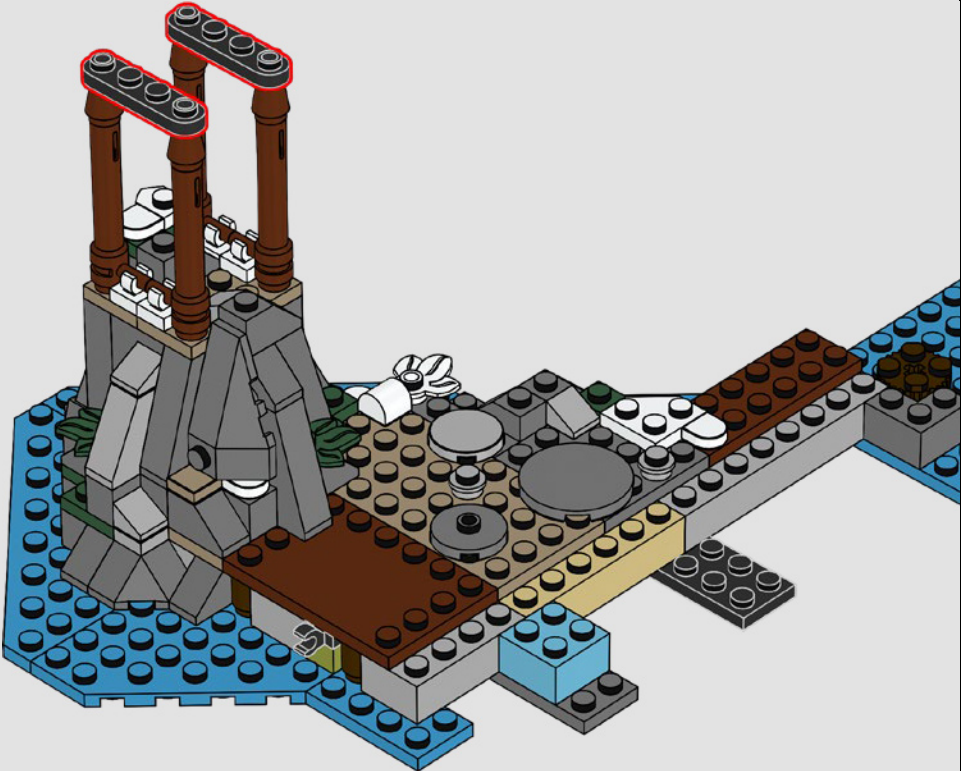

353

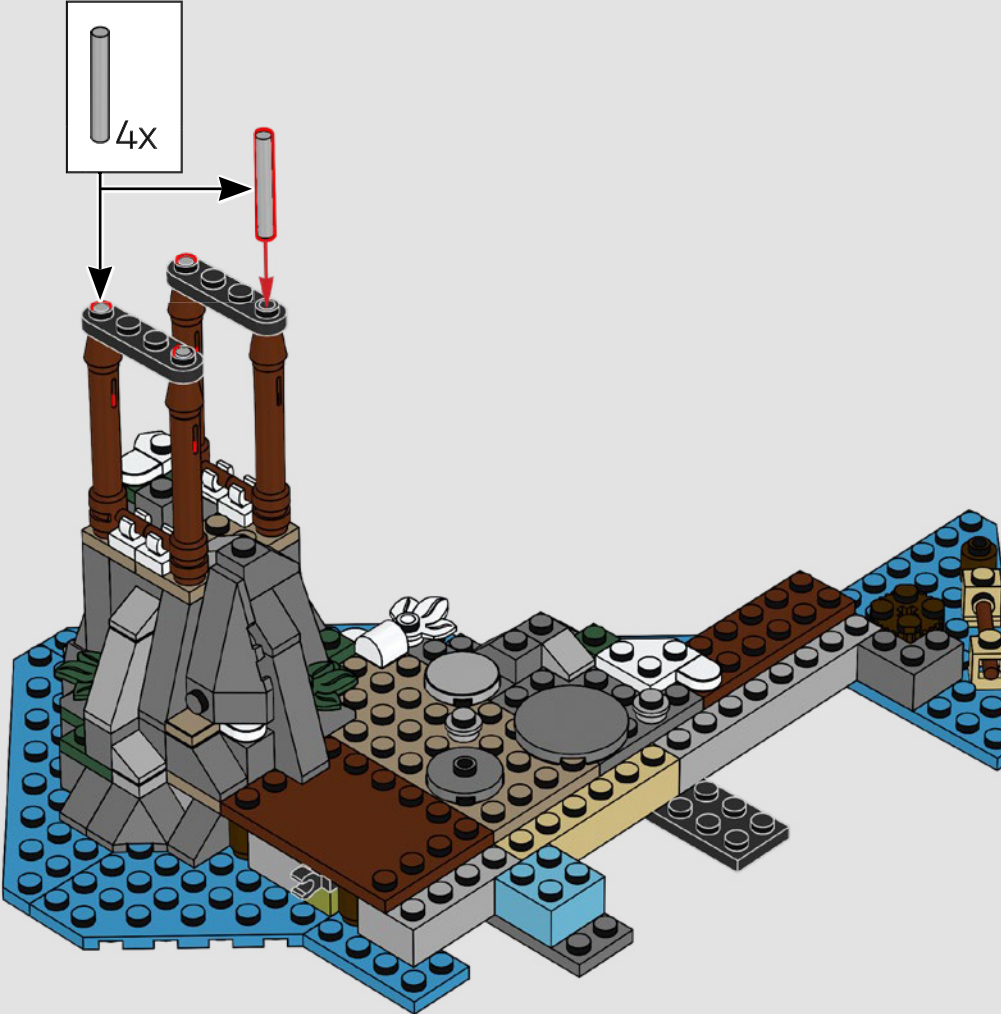

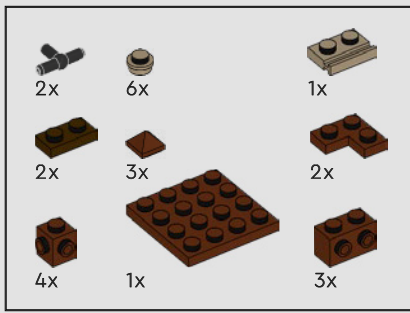

354

1

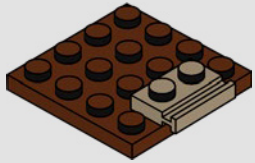

2

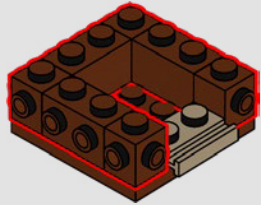

3

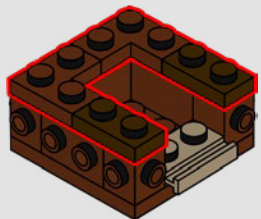

4

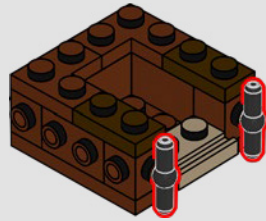

5

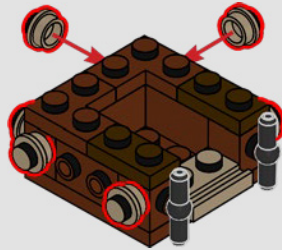

6

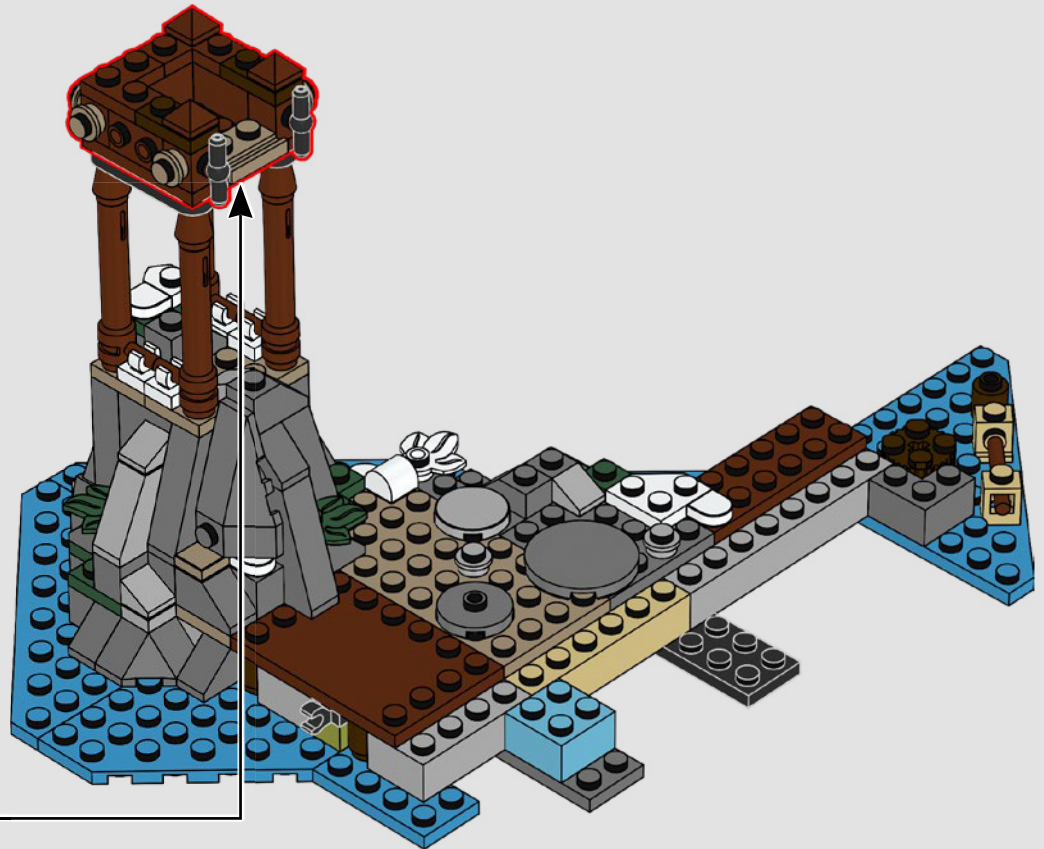
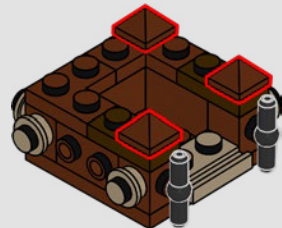

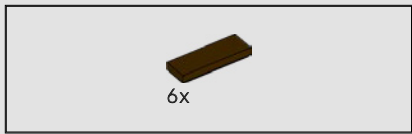

355



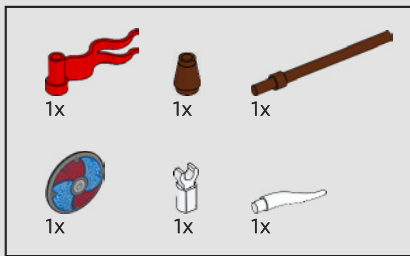

356

1



2

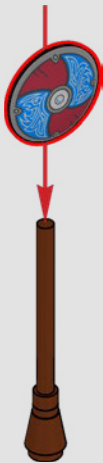

3

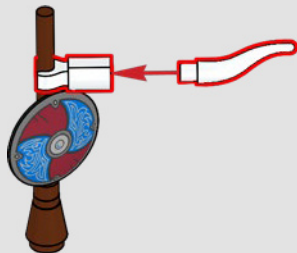

4

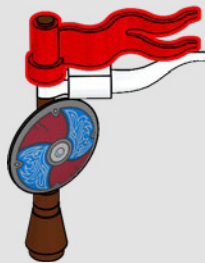

357



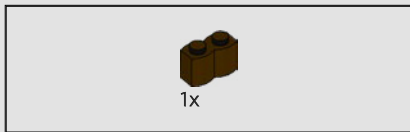

358

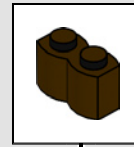

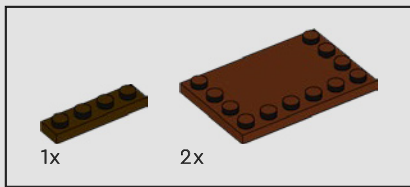

359



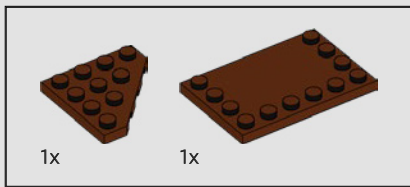

360

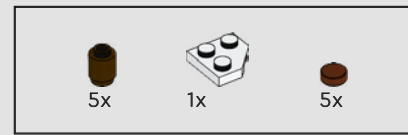

361

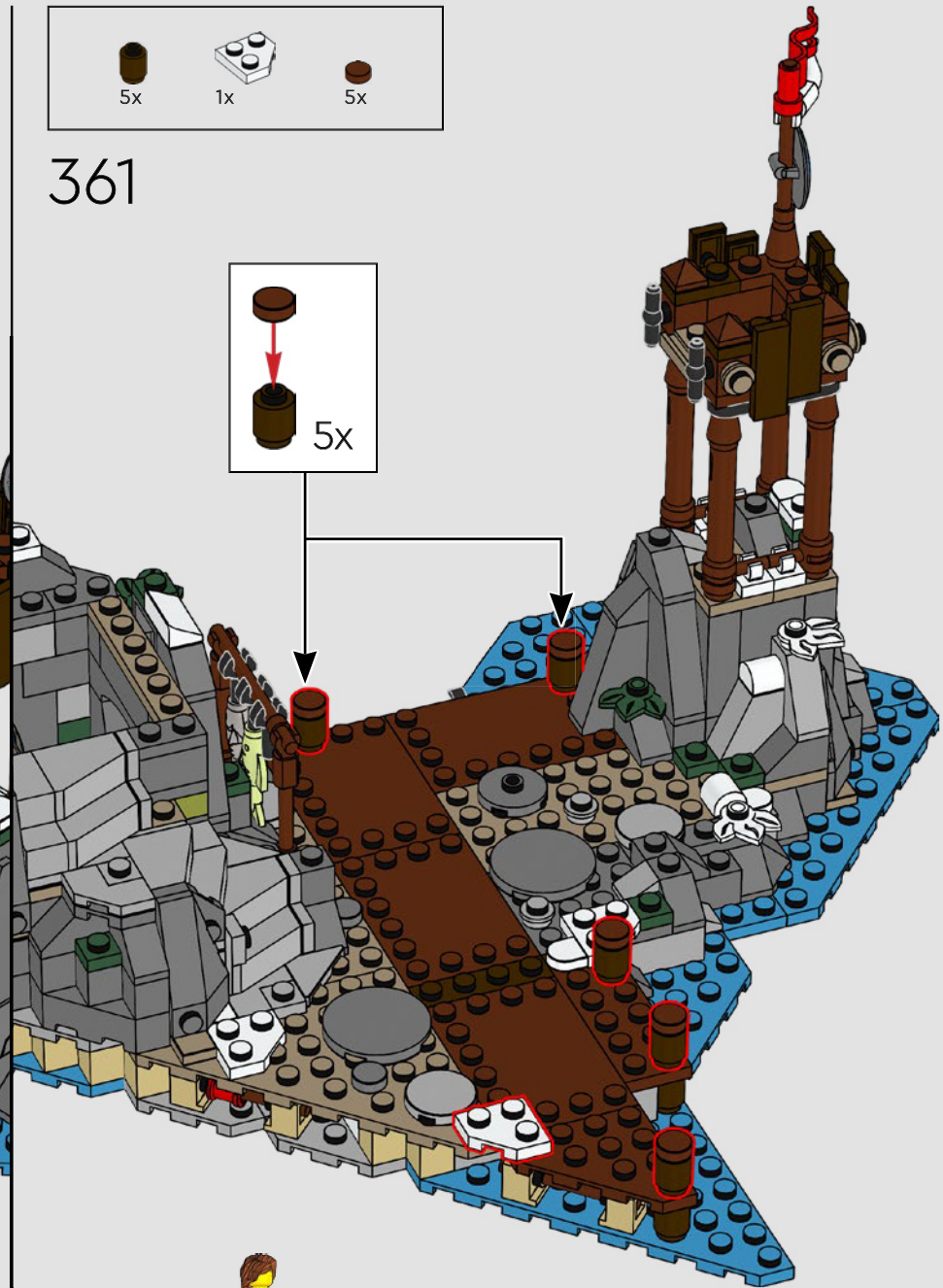
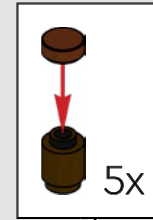

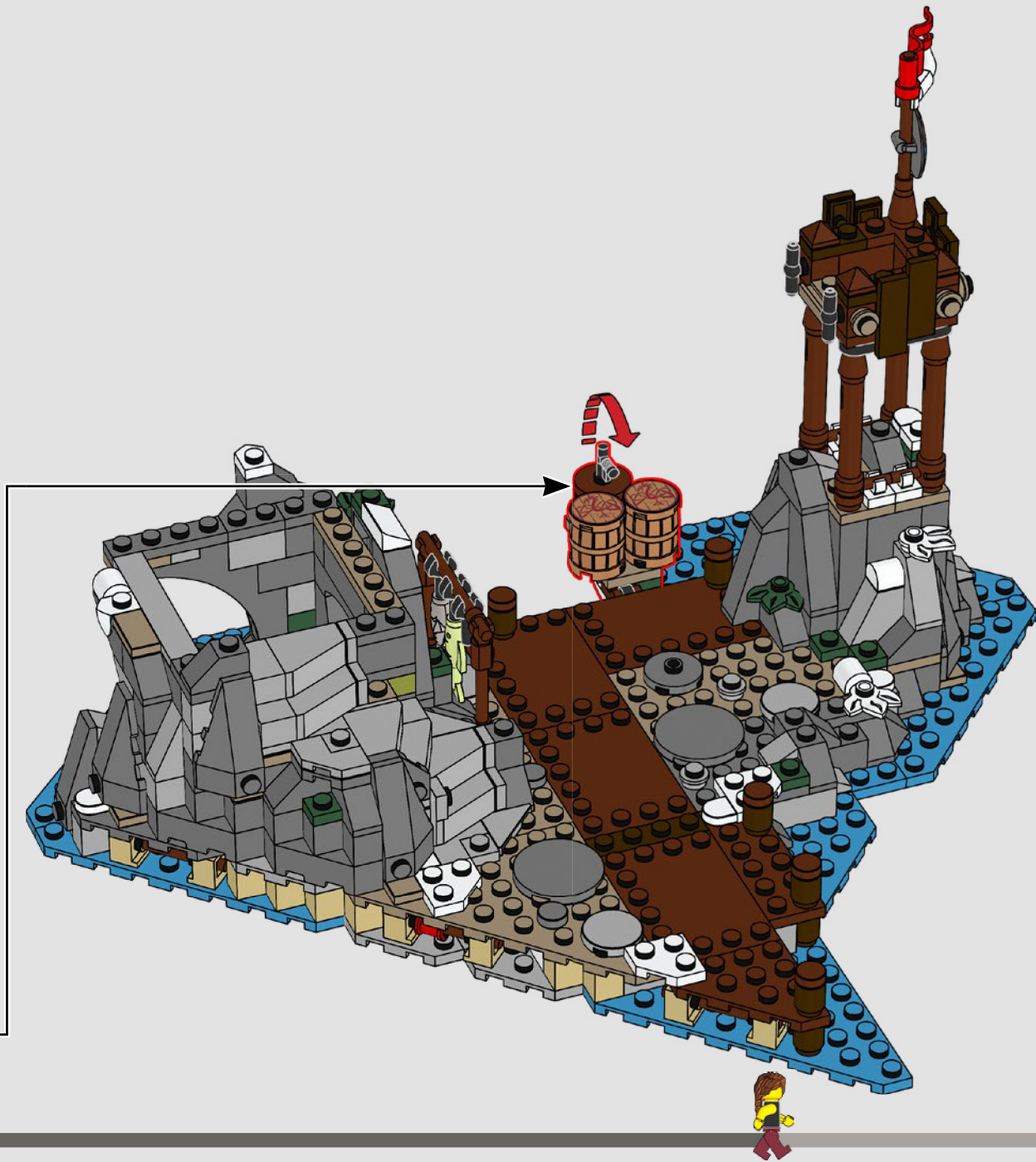

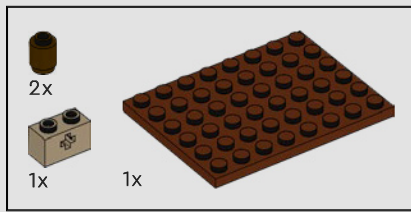

363

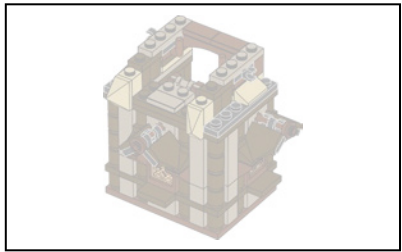
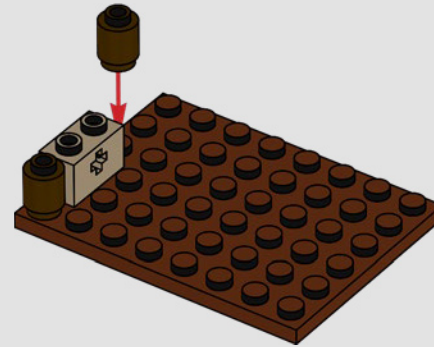

364

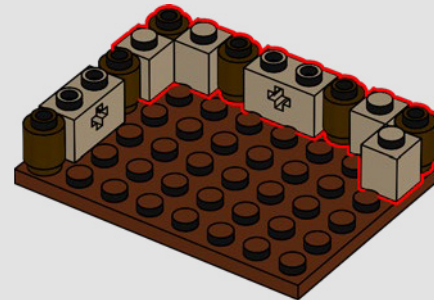



365

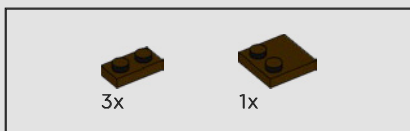
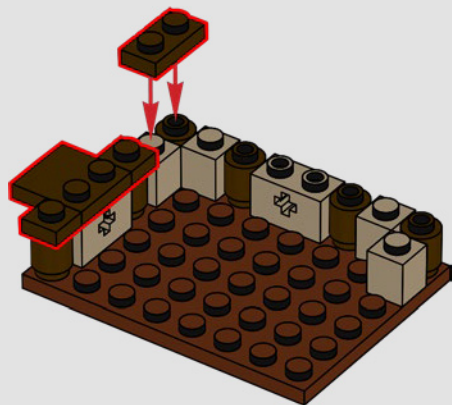

366

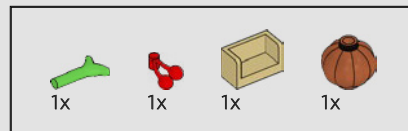
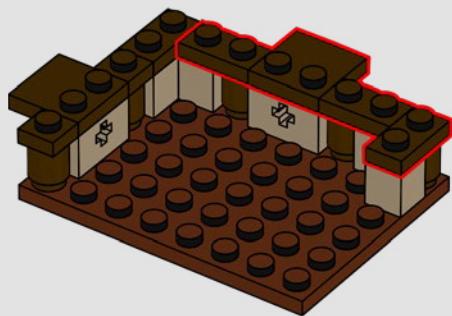

367

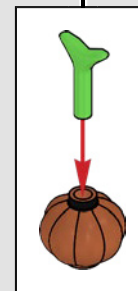
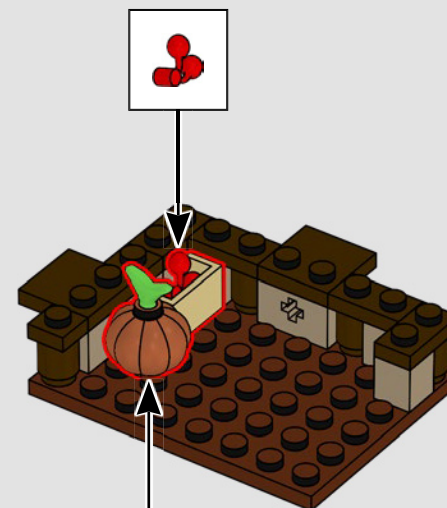

8x

368

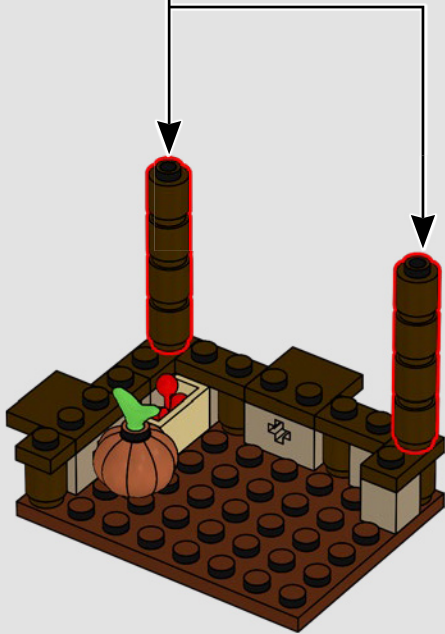
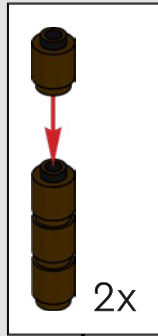

4x

4x

369

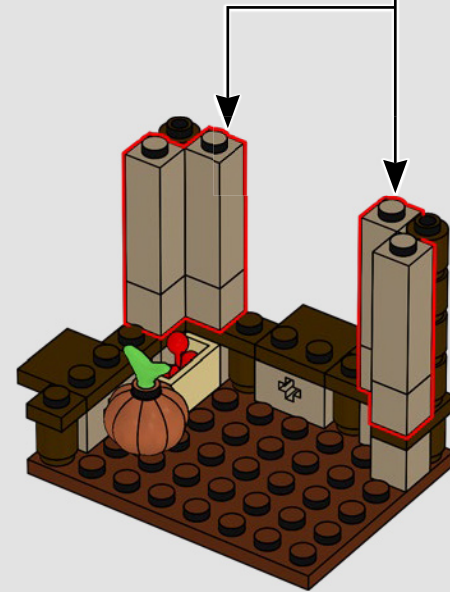
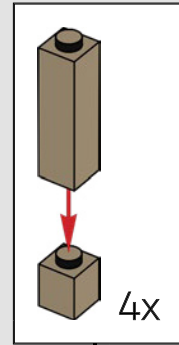

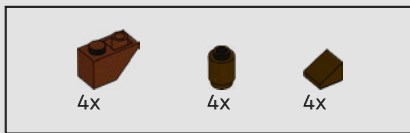

370

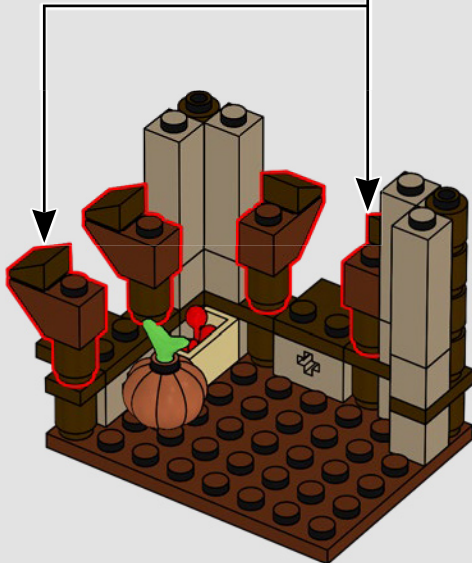
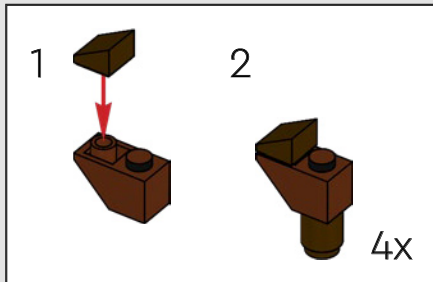

371

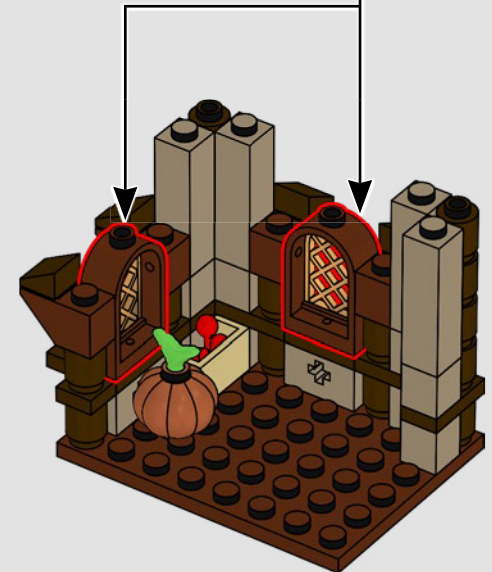
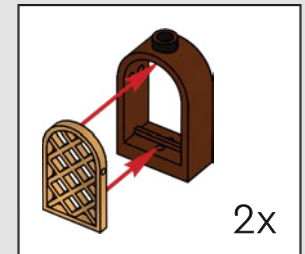

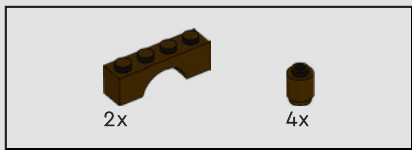

372

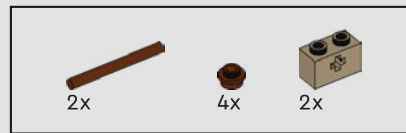
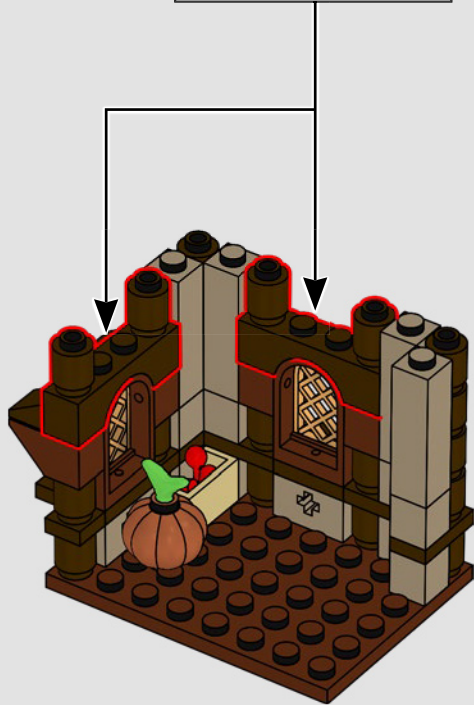
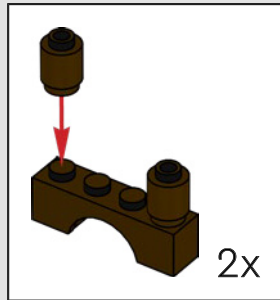

373

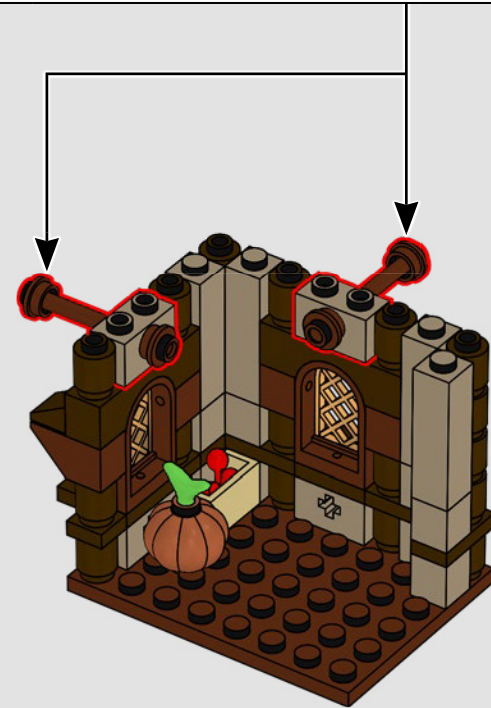
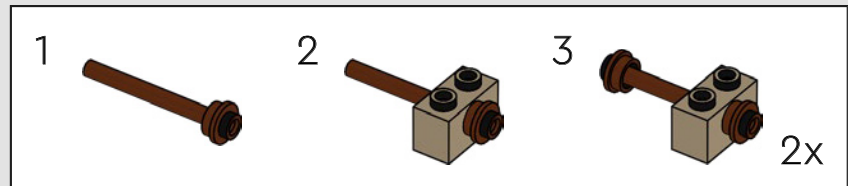

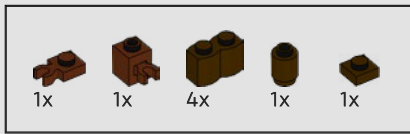

374

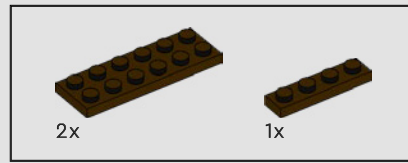
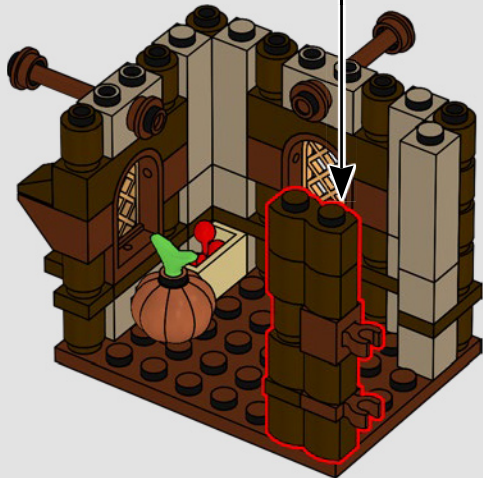
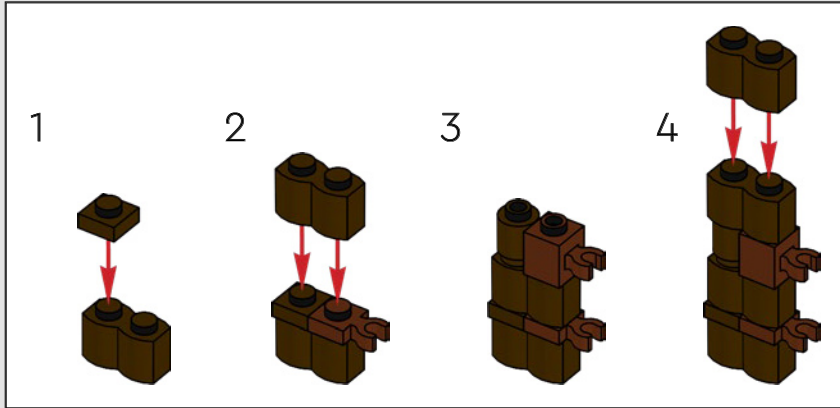

375



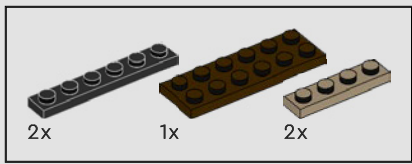

376

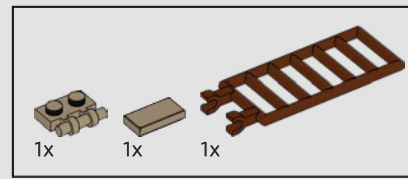

377

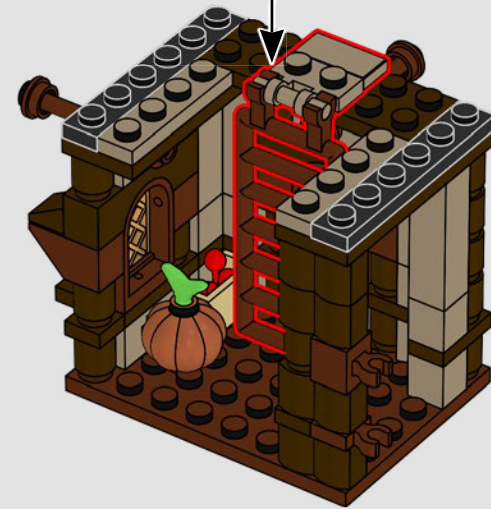
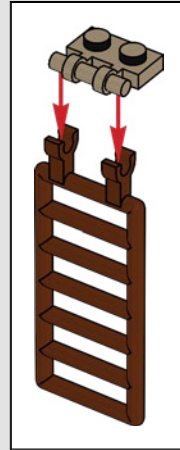



378

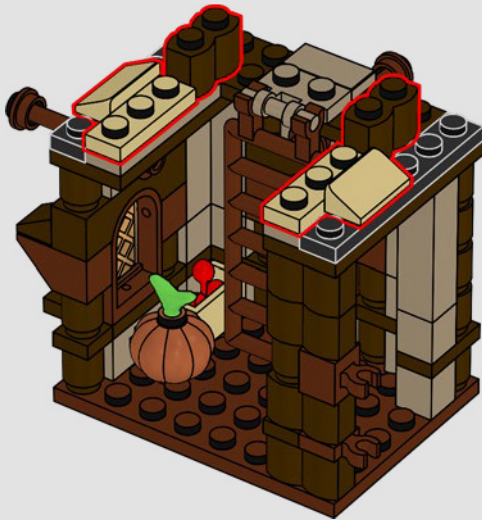

379

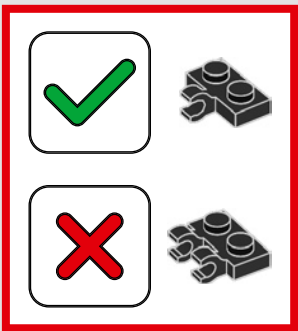
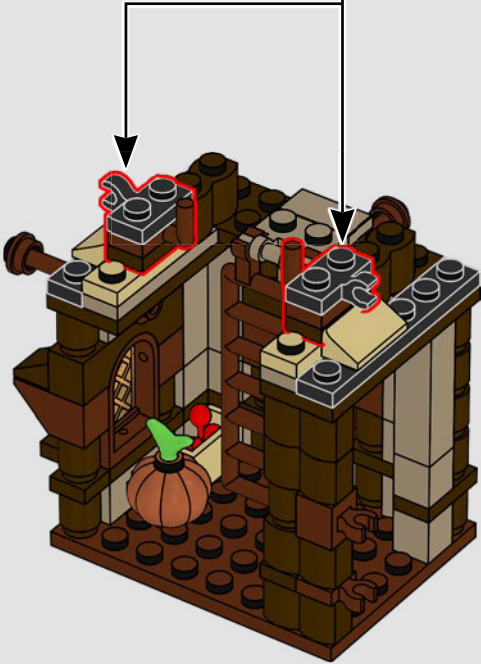
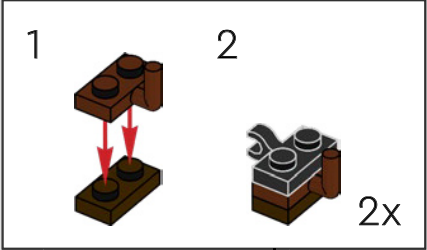

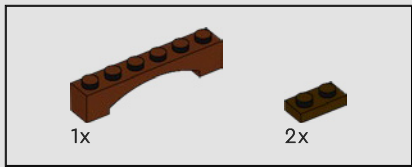

380

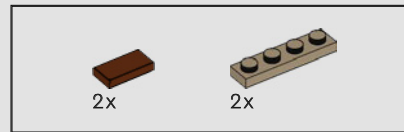

381



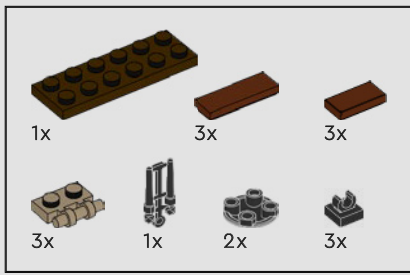

382

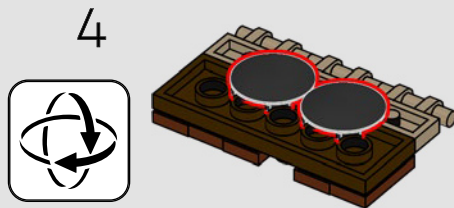
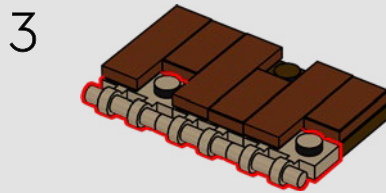
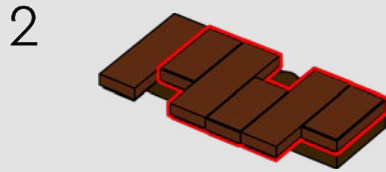
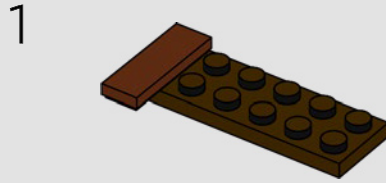

5

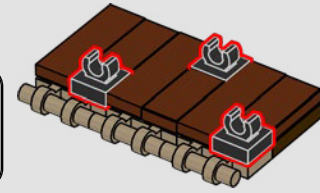
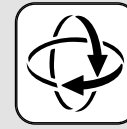

6

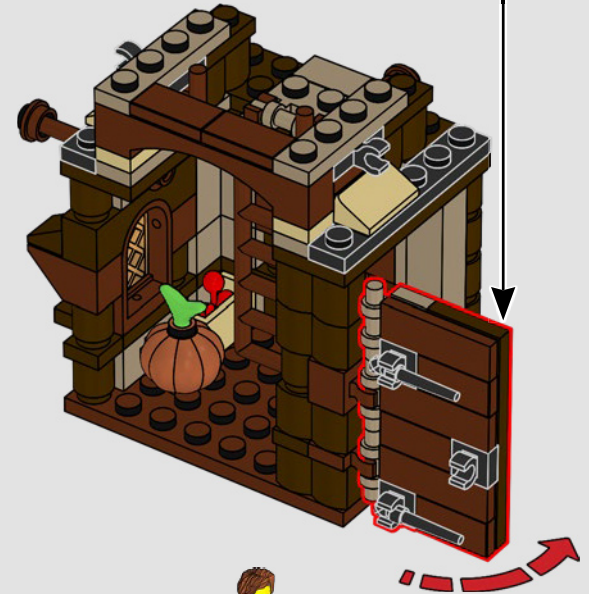
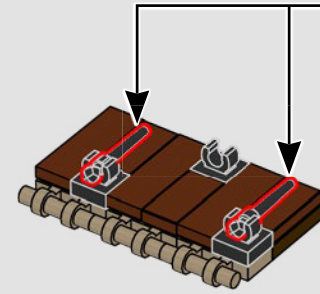

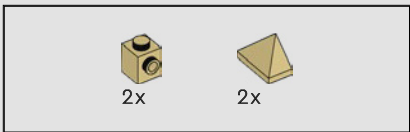

383

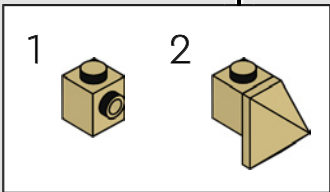
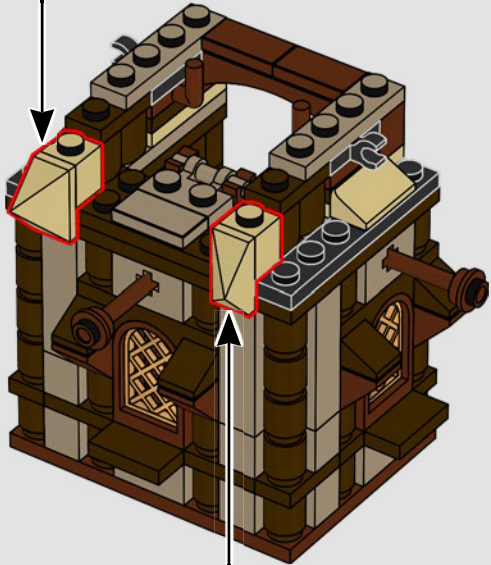
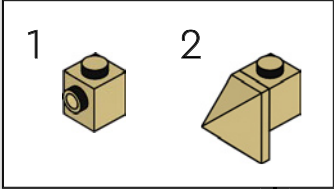

384

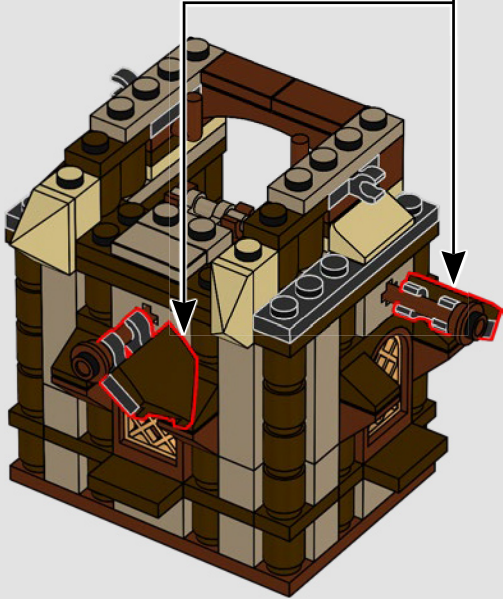
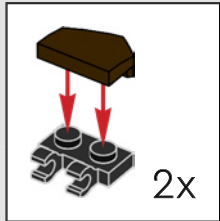
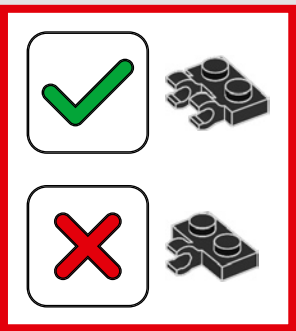



385

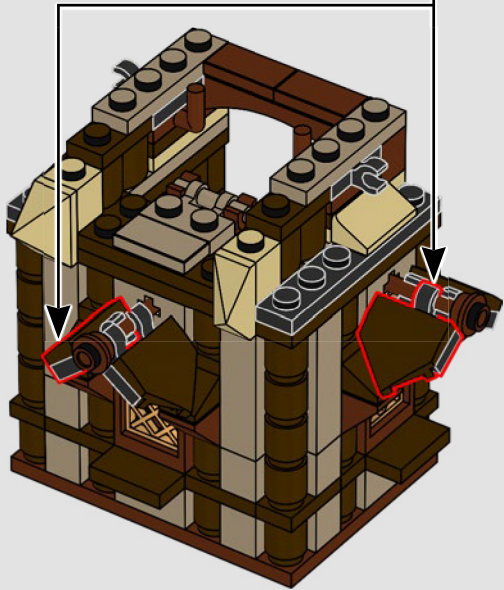
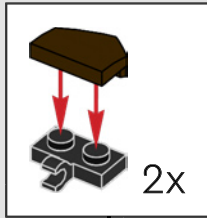
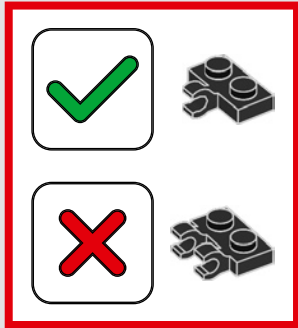

386



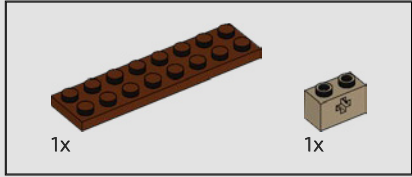
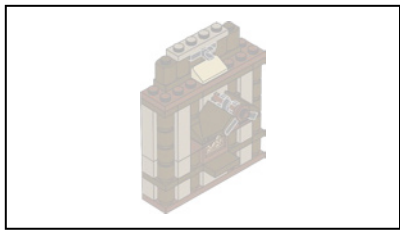

387

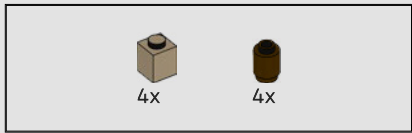
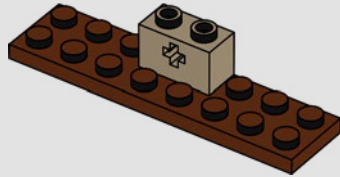

388

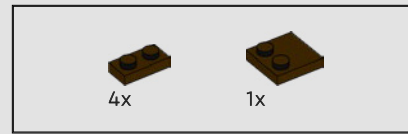
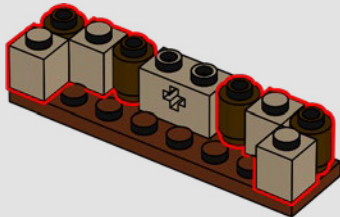

389

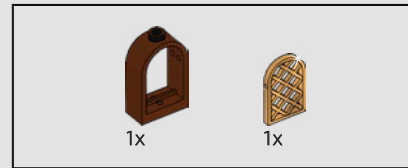
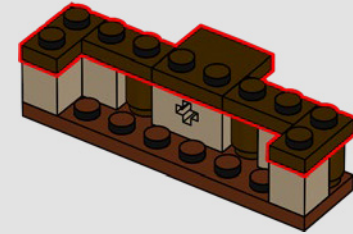

390

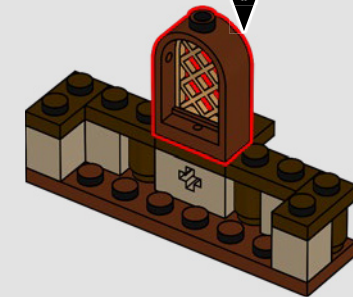
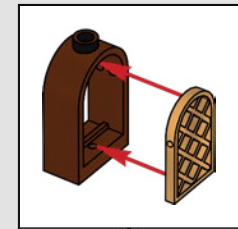

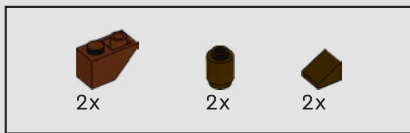

391

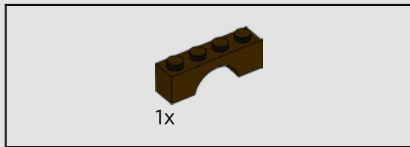
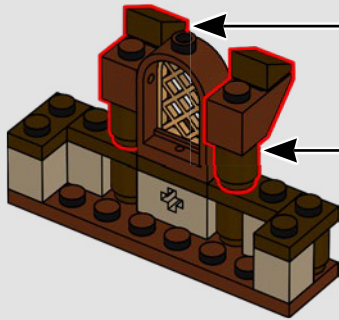
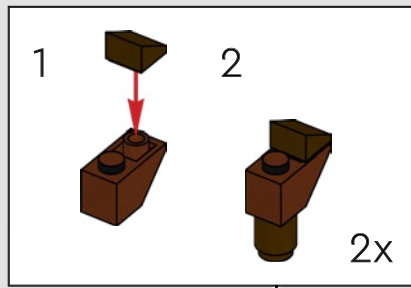

392

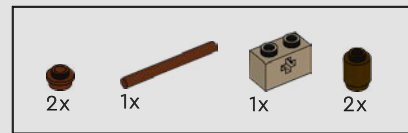
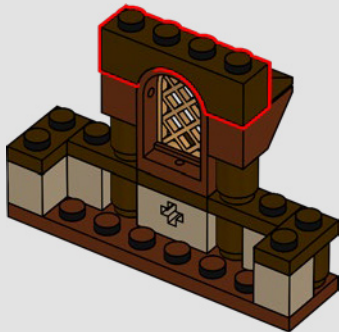

393

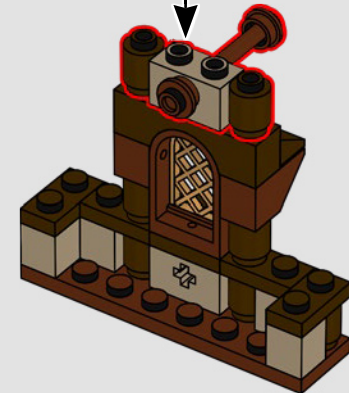
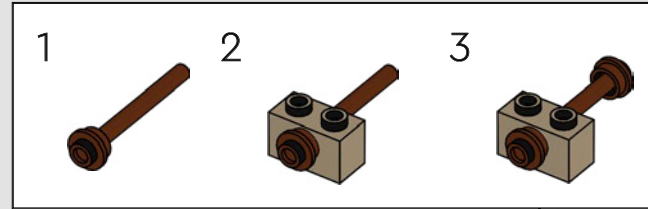

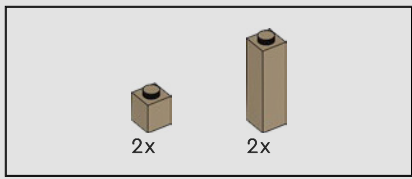

394

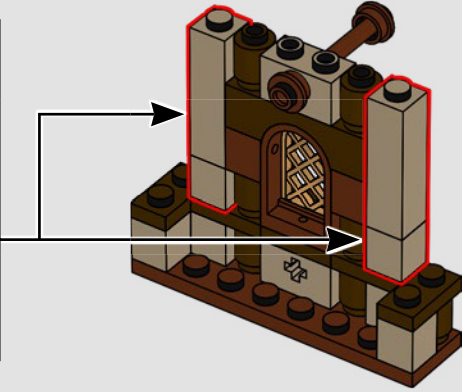
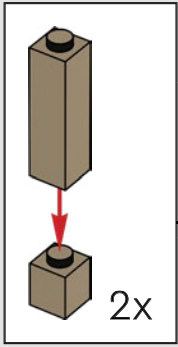

395

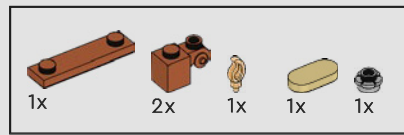
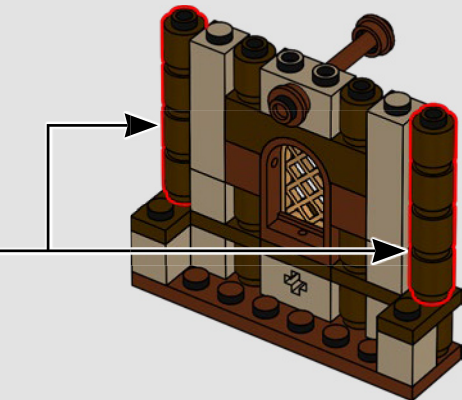
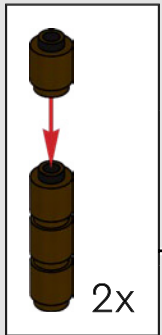

396

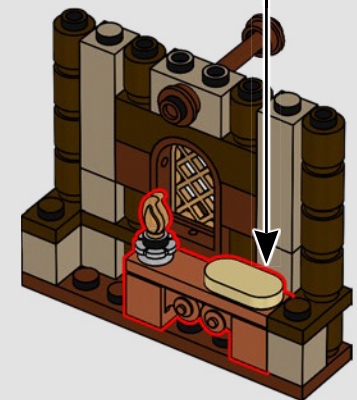
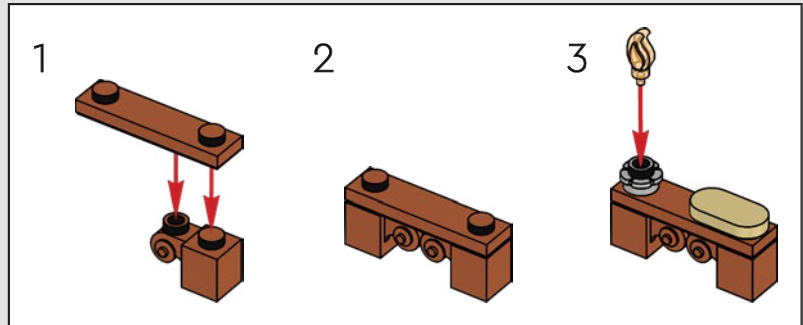

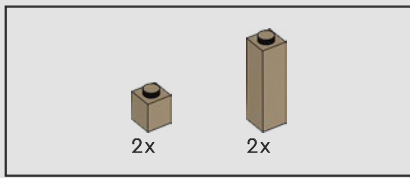

397

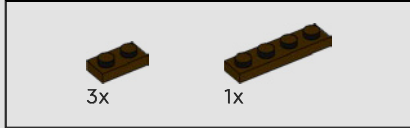
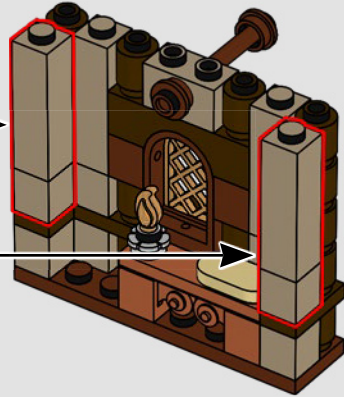
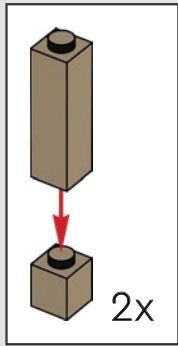

398

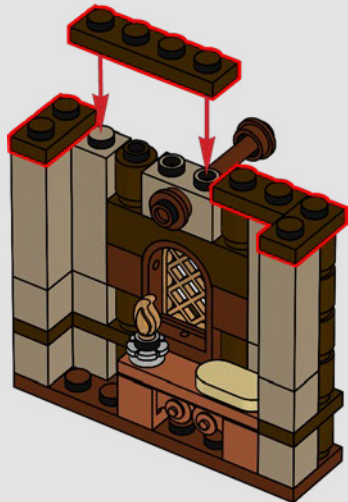

399

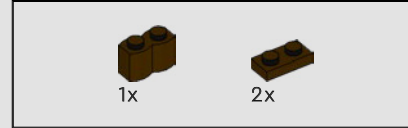
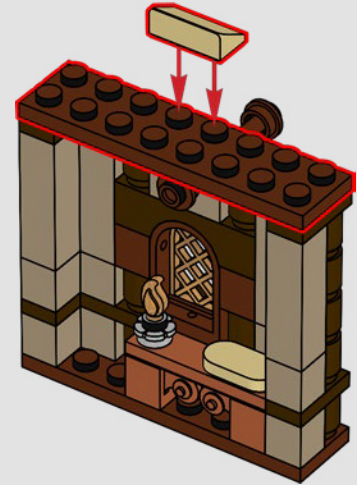

400

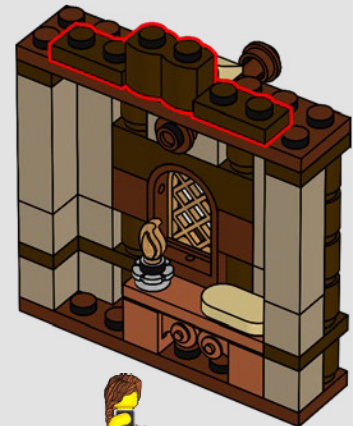

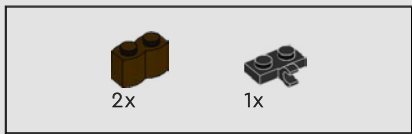

401

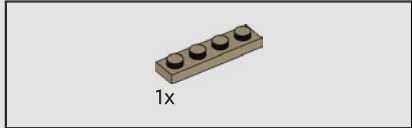
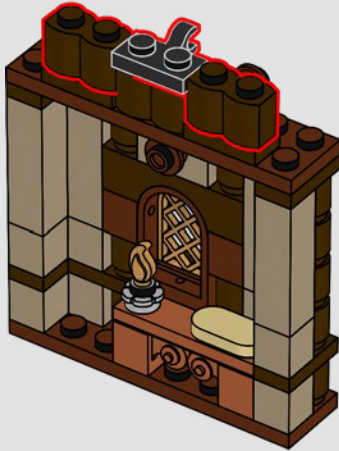

402



403

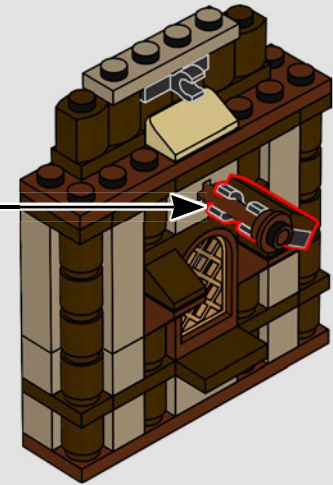
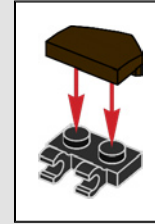

404

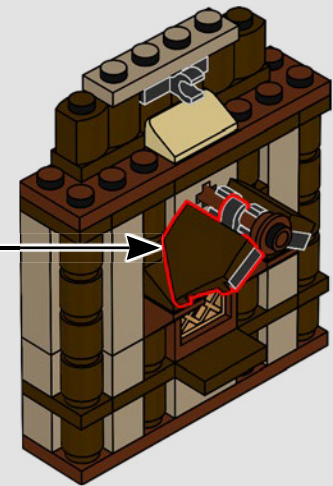
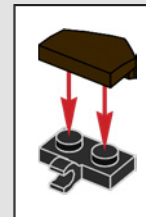

405



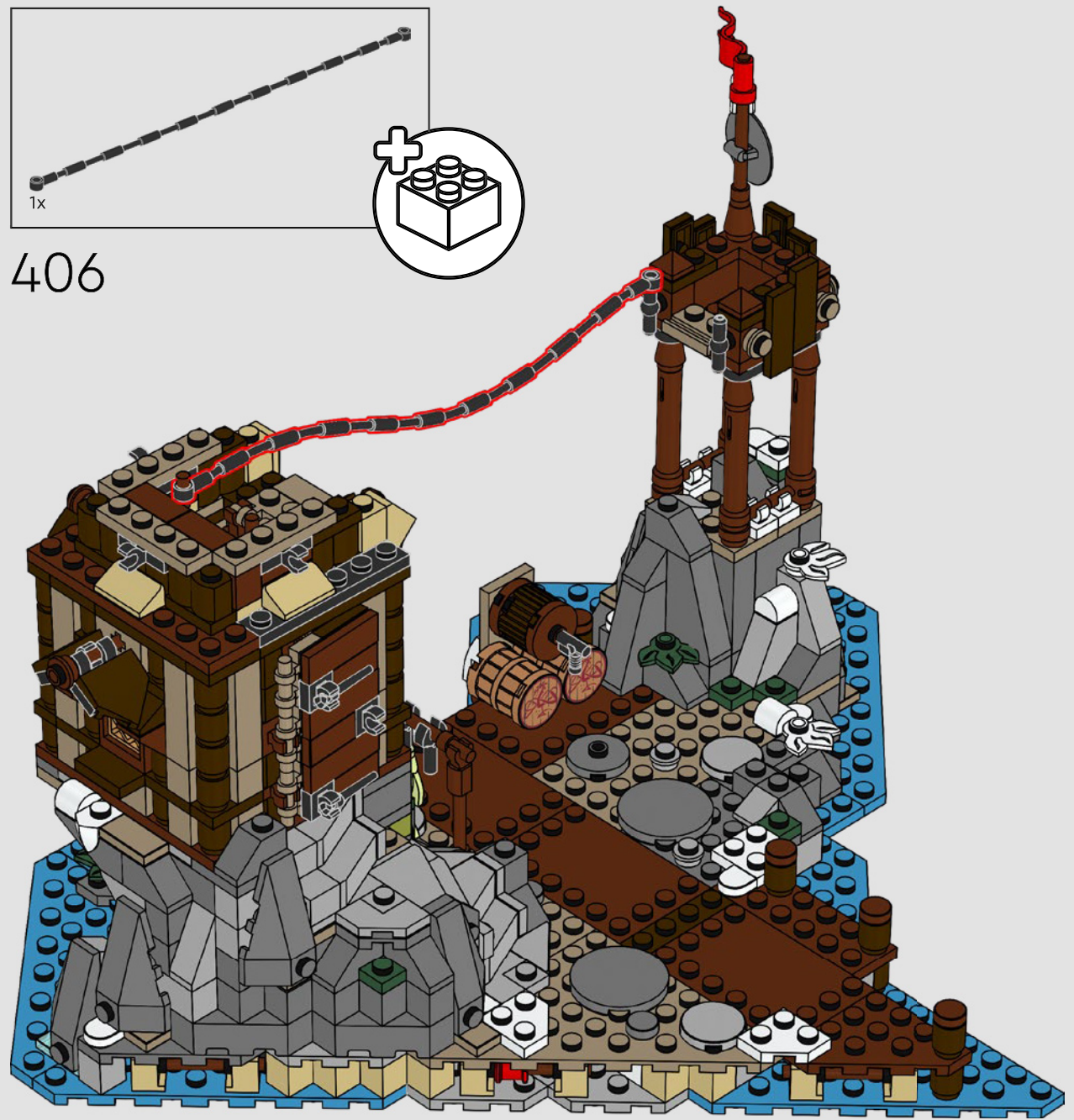
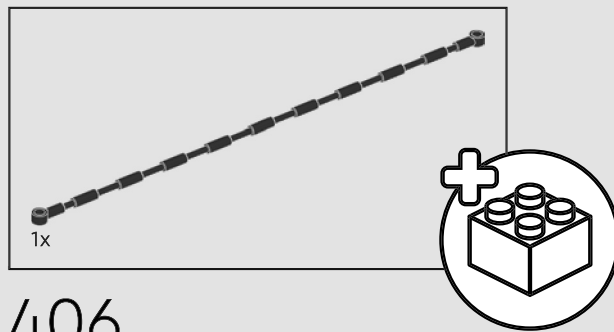
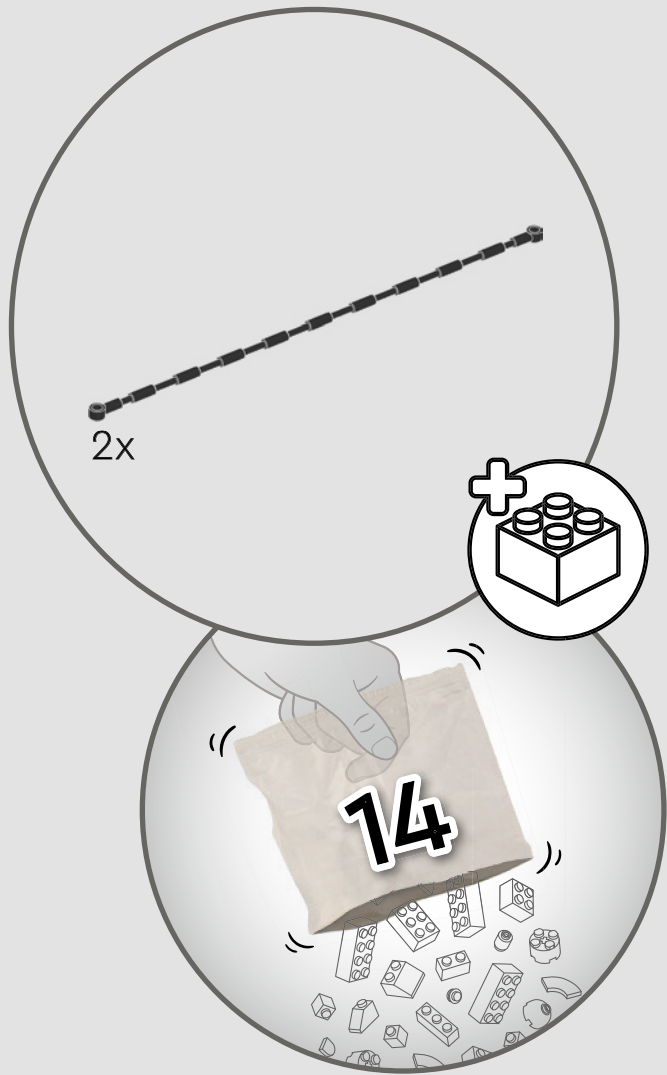

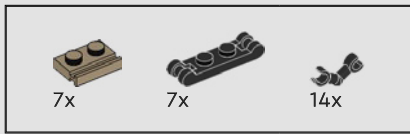

407

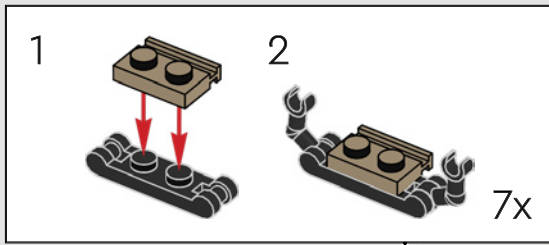

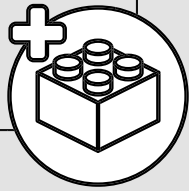
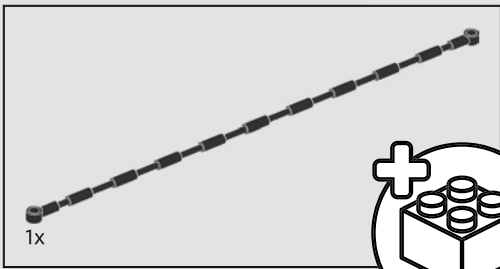

408



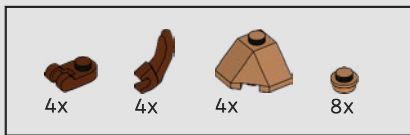

409

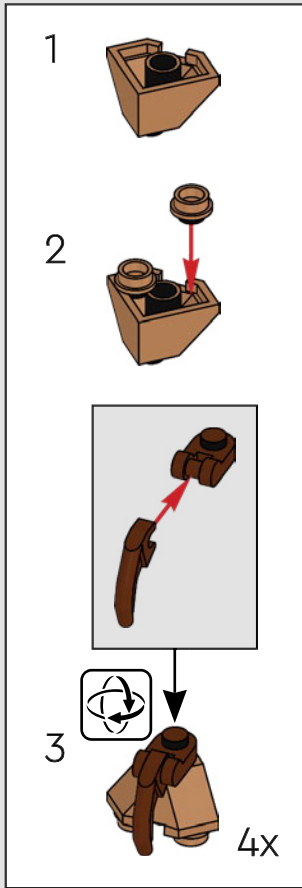

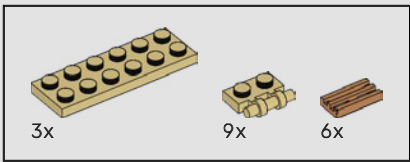

410

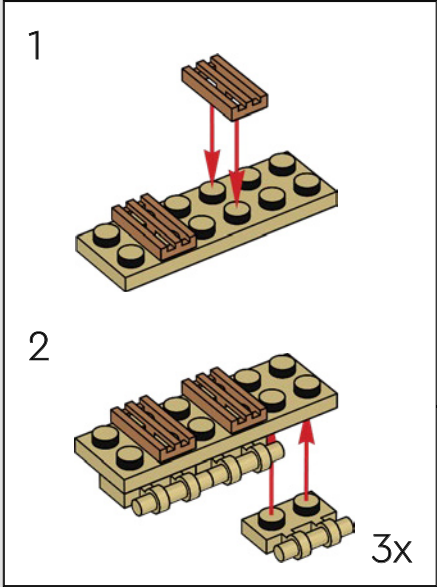

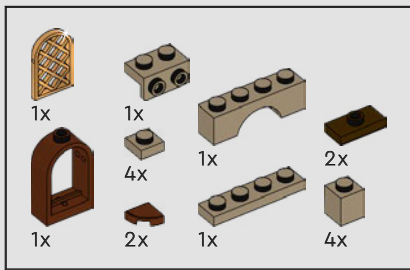

411

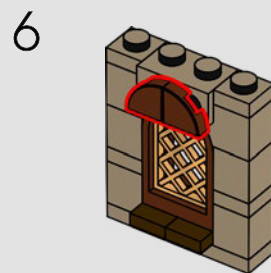
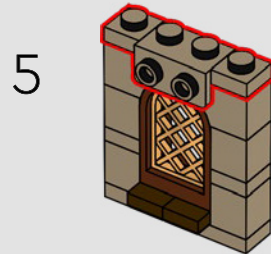
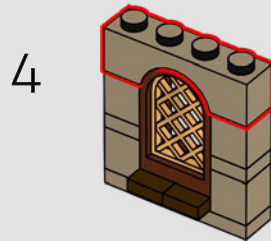
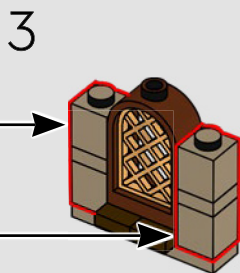
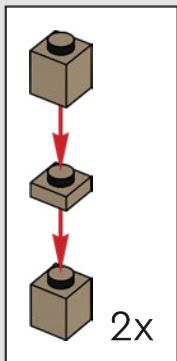
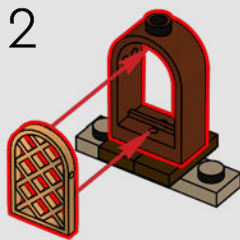
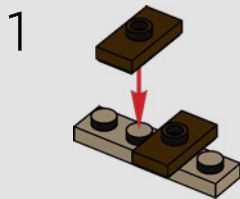

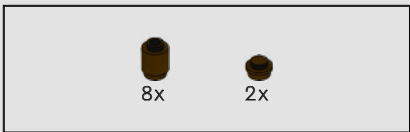

412

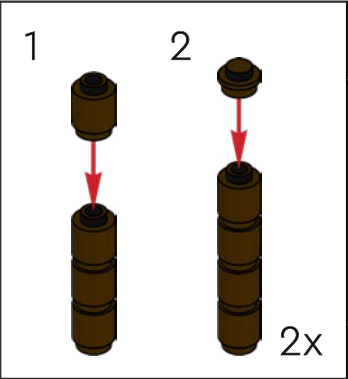



413



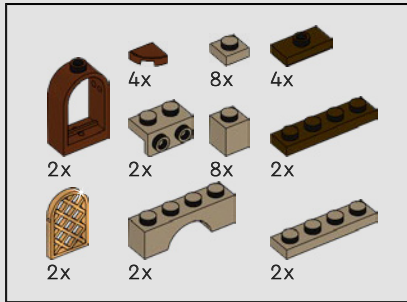

414

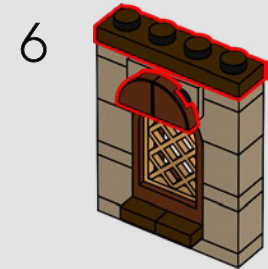
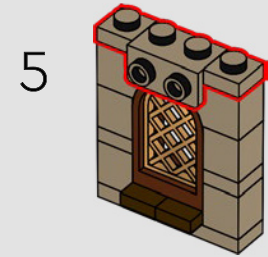
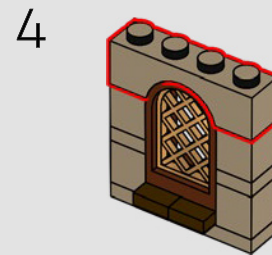
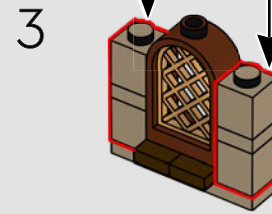
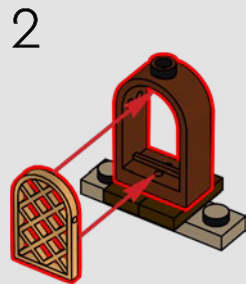
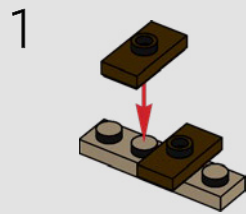

2x

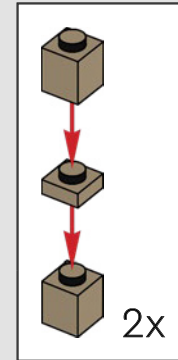



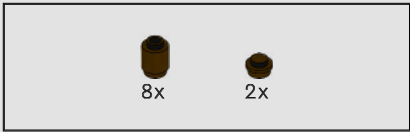

415

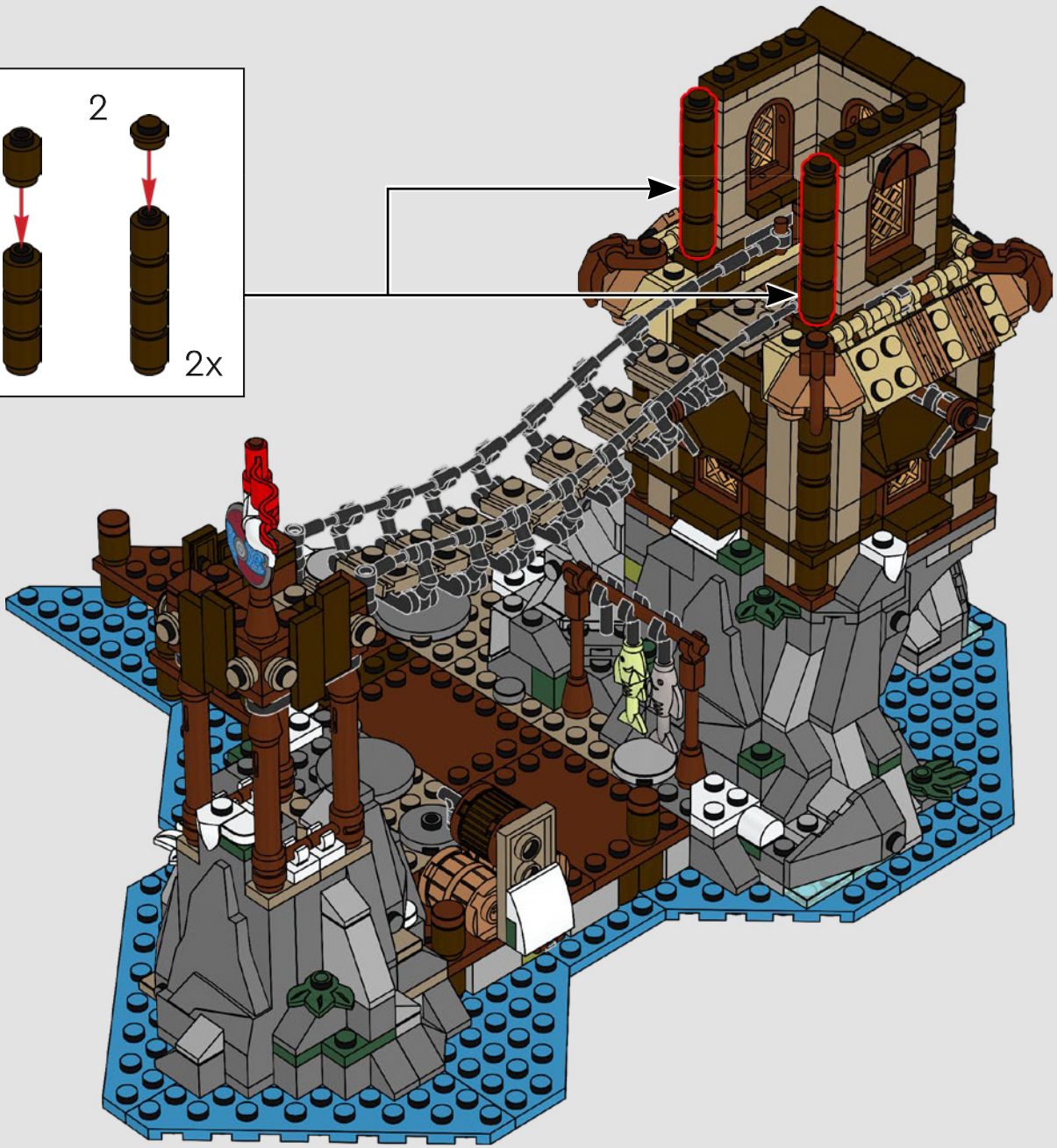
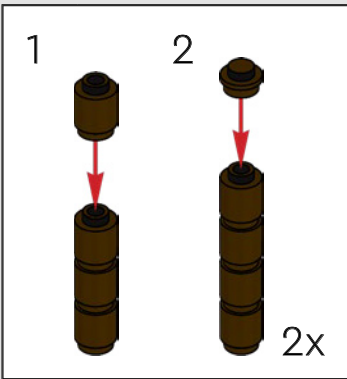

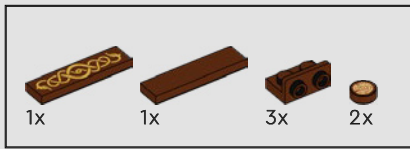

416

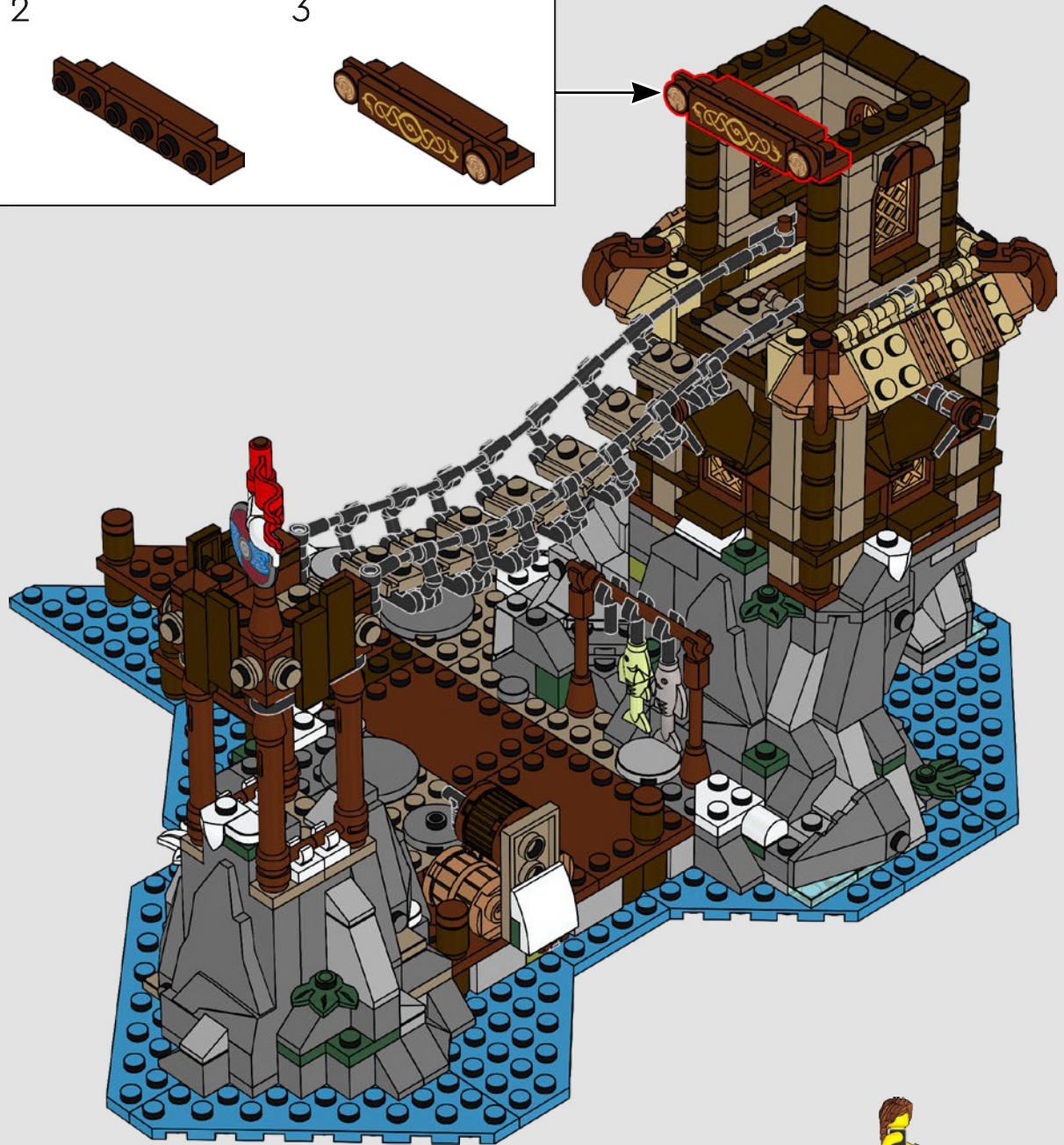
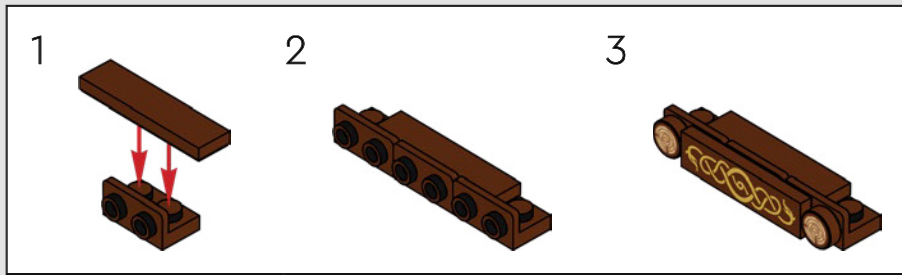

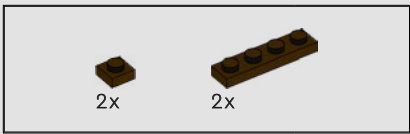

417



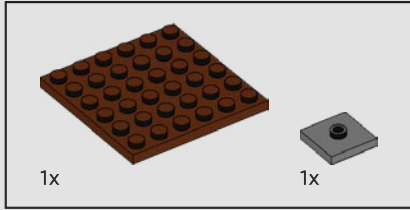
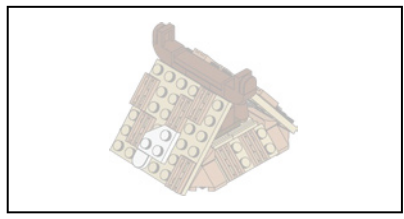

418

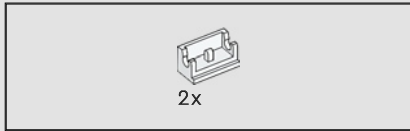
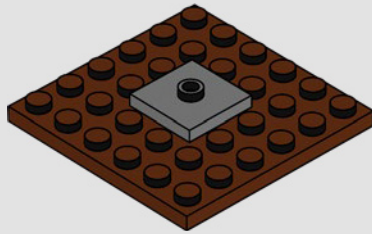

419

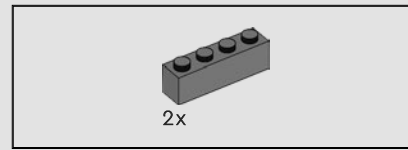
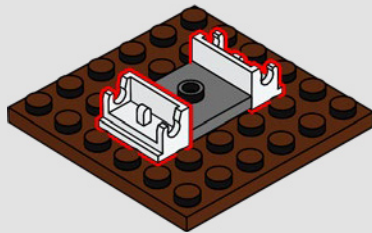

420

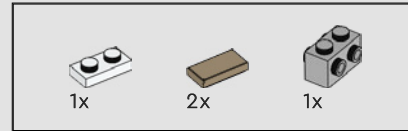
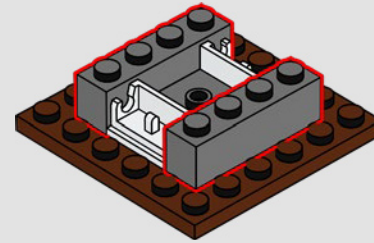

421

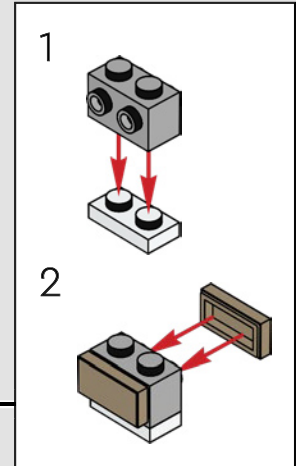
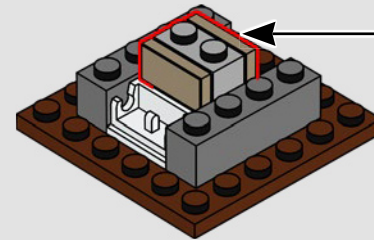

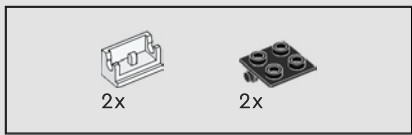

422

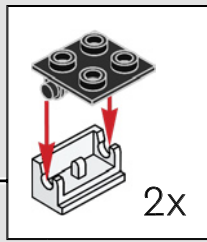
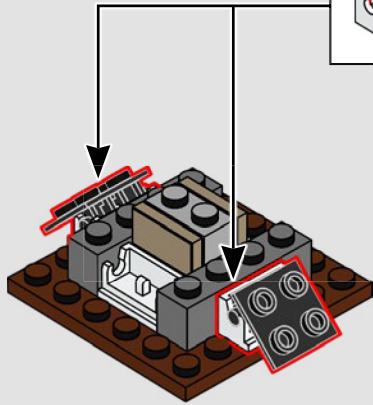

424

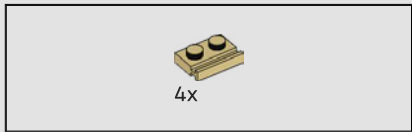
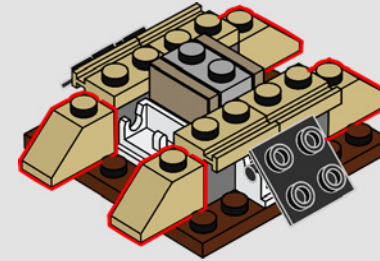

423

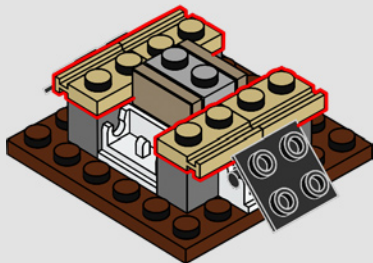

425

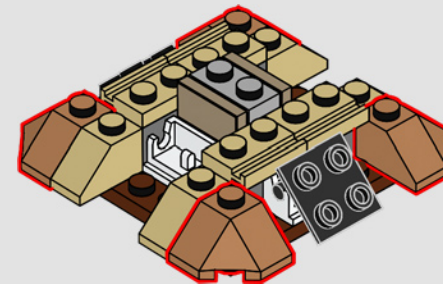



432







IDEAS

GATHER SUPPORT
OBTENEZ DE L'APPUI
OBTÉN APOYOS

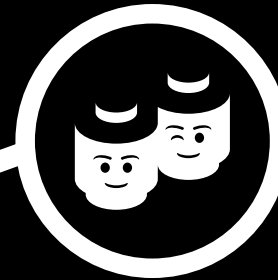

SHARE YOUR IDEA
PARTAGEZ VOTRE IDÉE
COMPARTE TU IDEA

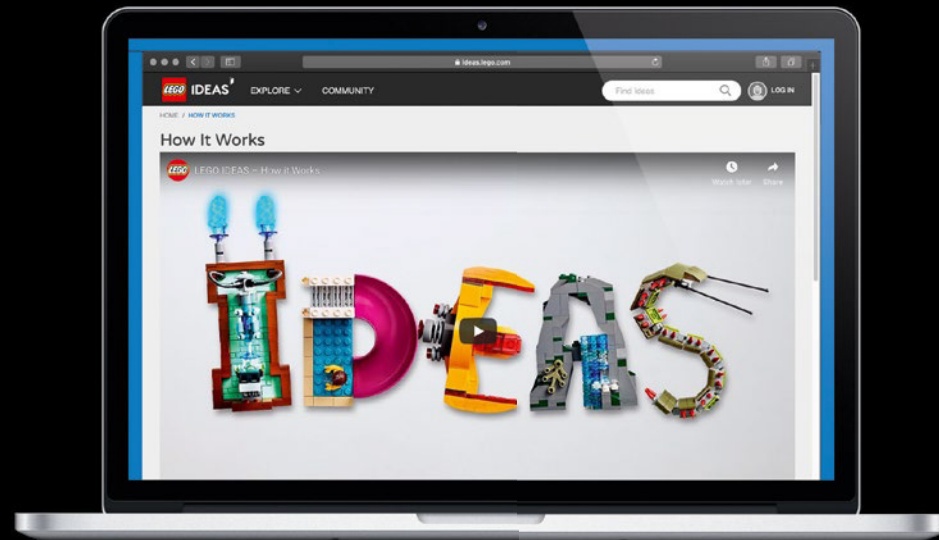
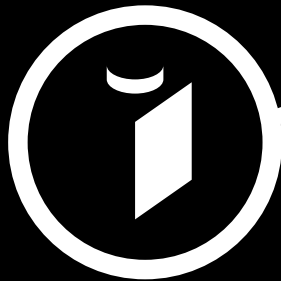

NEW LEGO® PRODUCT
NOUVEAU PRODUIT LEGO®
NUEVO PRODUCTO LEGO®

LEGO® REVIEW
EXAMEN LEGO®
REVISIÓN DE LEGO®

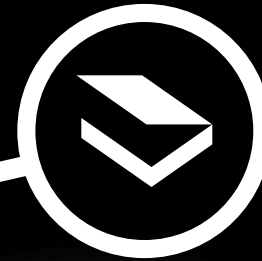
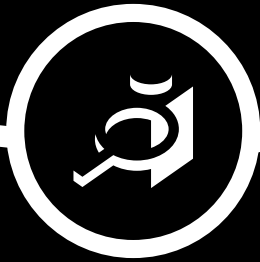

ideas.LEGO.com

- 3x 300901
- 1x 4518400
- 1x 4547489
- 9x 6258135
- 2x 6047220
- 1x 6210385
- 1x 6330960
- 5x 302301
- 4x 362301
- 3x 371001
- 4x 6348055
- 2x 6361170
- 1x 6168642
- 18x 6250591
- 17x 6176240
- 2x 6382783
- 2x 4579260
- 3x 6439714
- 3x 6334087
- 1x 6417971
- 2x 6270106
- 2x 6328195
- 1x 6269074
- 7x 6046905
- 1x 6341465
- 1x 6439046
- 4x 393701
- 8x 4124455
- 4x 4181134
- 2x 6037398
- 12x 4118793
- 1x 4114324
- 1x 4529237
- 2x 6312460
- 3x 4624086
- 4x 4121972
- 2x 6058090
- 3x 4113917
- 4x 6092587
- 10x 6173057
- 2x 4121921
- 2x 4118790
- 3x 4113233
- 4x 4114309
- 5x 6122047
- 3x 4113993
- 1x 4114324
- 6x 4114001
- 11x 4113988
- 2x 4125217
- 1x 4509897
- 3x 6156462
- 1x 6313611
- 4x 6249809
- 4x 4160483
- 9x 4140593
- 16x 6469454
- 3x 6443061
- 1x 6397819
- 1x 6138230
- 1x 6228984
- 1x 6248495
- 1x 6454364
- 1x 4666579
- 1x 4179355
- 1x 6177505
- 1x 6177507
- 2x 4533742
- 1x 6268946
- 1x 6100565
- 2x 6271820
- 1x 4142865
- 1x 6057802
- 2x 6299413
- 1x 6223923
- 1x 6352820
- 1x 6446935
- 1x 6446937
- 1x 4644456
- 2x 300326
- 8x 6228987
- 1x 6138173
- 3x 4159550
- 2x 654126
- 4x 6435928
- 3x 302226
- 2x 366626
- 3x 303426
- 1x 303526
- 1x 6186675
- 4x 6424674
- 3x 6335388
- 2x 6335317
- 1x 6308000
- 3x 6330189
- 9x 6313116
- 4x 6000650
- 3x 6310268
- 1x 6469445
- 7x 6099483
- 1x 6210270
- 2x 4278359
- 2x 6428167
- 5x 6093525
- 1x 6170421
- 1x 6460919
- 15x 6326681
- 1x 6270027
- 1x 4537551
- 2x 452226
- 1x 4273590
- 2x 6315887
- 10x 6439039
- 9x 6279875
- 1x 370526
- 2x 393726
- 6x 4124096
- 2x 6104209
- 2x 6440995
- 12x 6135287
- 13x 6269971
- 4x 6382575
- 1x 6359662
- 1x 4119479
- 2x 6092602
- 1x 6257603
- 7x 6315782
- 1x 6451320
- 1x 6409765
- 1x 6360331
- 1x 6426472
- 2x 6429032
- 6x 6251295
- 1x 6252049
- 1x 6240225
- 4x 6245277
- 1x 4118782
- 1x 6240515
- 28x 6001824
- 8x 6310988
- 3x 4646577
- 3x 4255416
- 4x 6310835
- 6x 6310833
- 4x 6015449
- 6x 6093038
- 3x 6310832
- 2x 6055172
- 12x 4549436

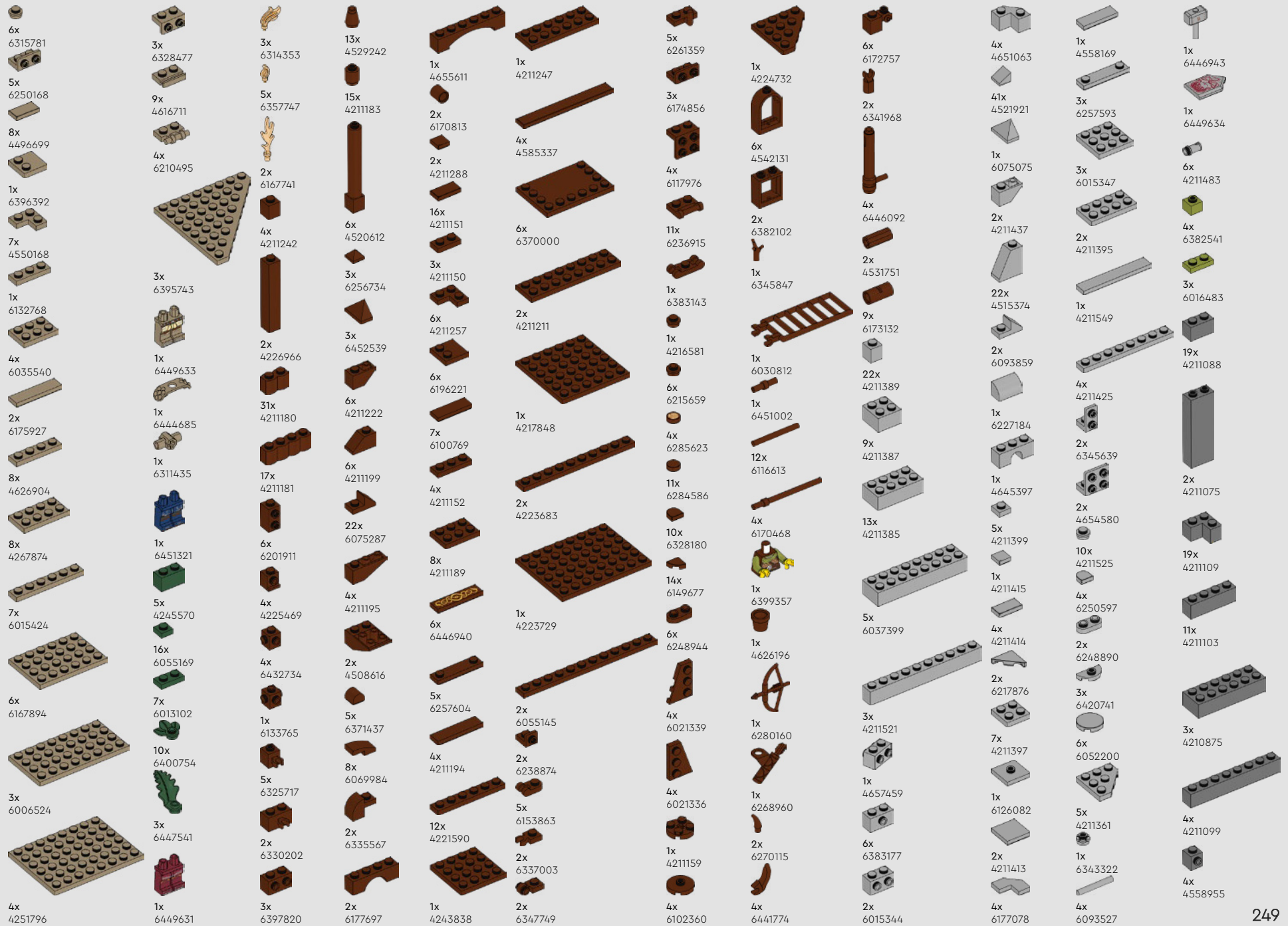

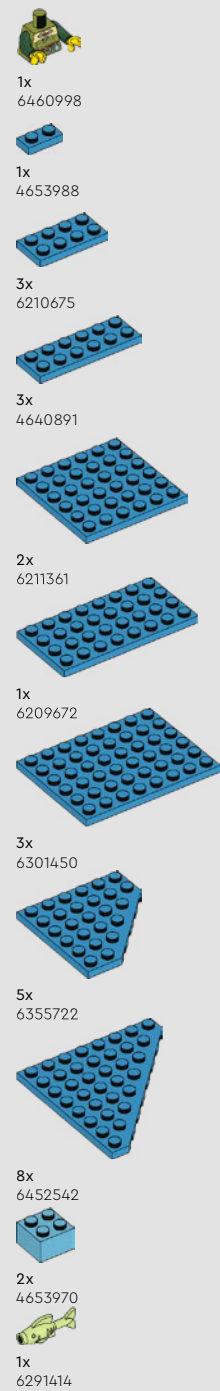
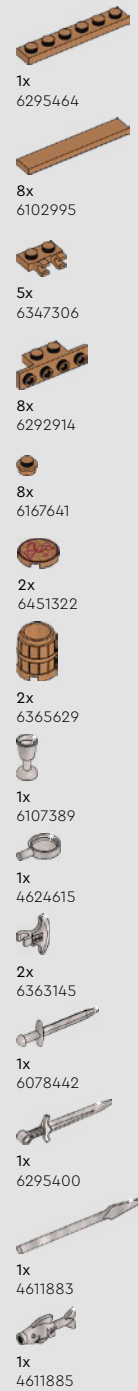
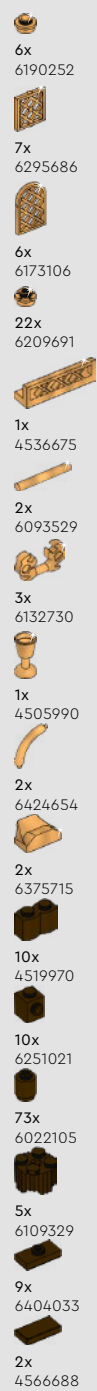
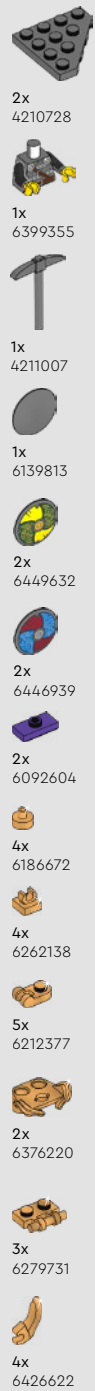
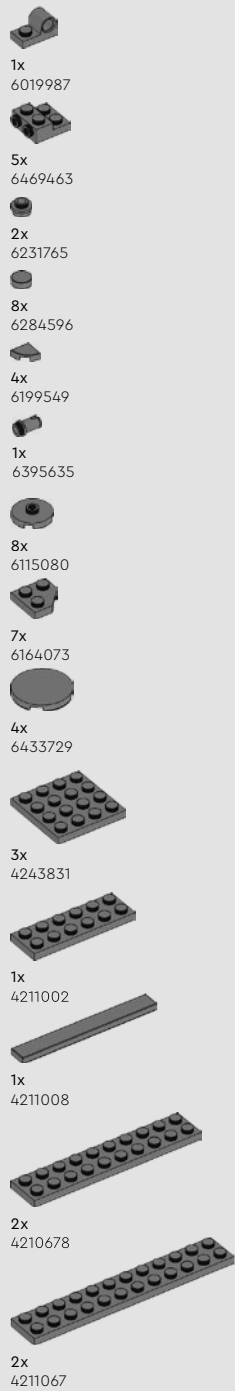
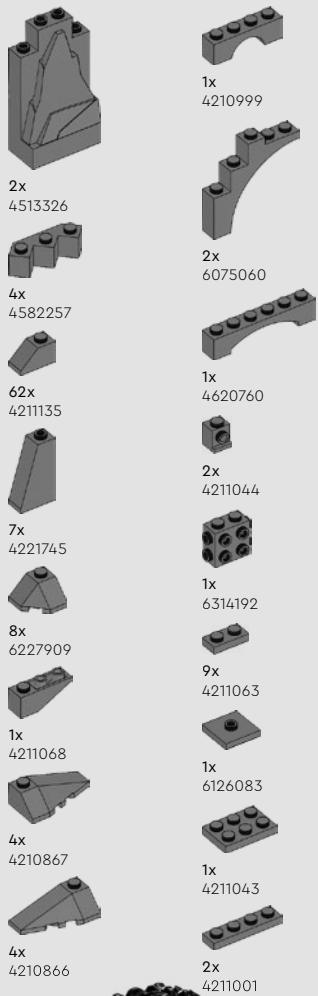

[LEGO.com/service](https://www.LEGO.com/service)



YOU COULD WIN



YOU COULD WIN

Your feedback will help shape the future development of this product series.

Visit:

DU KÖNNTEST GEWINNEN

Dein Feedback trägt zur Weiterentwicklung dieser Produktreihe bei.

Geh auf:

VOUS POURRIEZ GAGNER

Vos commentaires nous aideront à concevoir les futurs produits de cette gamme.

Visitez :

POTRESTI VINCERE TU

La tua opinione ci aiuterà a migliorare la creazione futura di questa linea di prodotti.

Visita:

PUEDES GANAR

Tu opinión contribuirá al futuro de esta serie de productos.

Visita:

轻松获奖

您的反馈将有助于我们在今后改进本产品系列。

请访问:

LEGO.com/productfeedback

You also have the chance to win a LEGO® set.

Terms and conditions apply.*

Außerdem hast du die Chance, ein LEGO® Set zu gewinnen.

Es gelten die Teilnahmebedingungen.*

Vous pourriez également gagner un ensemble LEGO®.

Des conditions s'appliquent.*

Hai anche la possibilità di vincere un set LEGO®.

Termini e condizioni sono applicabili.*

También tienes la oportunidad de ganar un set LEGO®.

Aplican términos y condiciones.*

您还有机会赢取乐高®套装。

条款和条件适用。*

*LEGO.com/productfeedback-terms



LEGO and the LEGO logo are trademarks of the/sont des marques de commerce du/son marcas registradas de LEGO Group.
©2023 The LEGO Group.

6483079