



ADVENTURE TIME

21308



 [LEGO.com/ideas](https://www.lego.com/ideas)

It's Adventure Time™!

Finn and his best friend and adopted brother, Jake, roam the Land of Ooo, righting wrongs and battling evil. Along the way, they make friends with a whole range of wacky characters such as Princess Bubblegum, Lady Rainicorn and Marceline the Vampire Queen. They also have to deal with the grumpy Ice King, the mean ruler of the Ice Kingdom, who really needs to chill out.

The animated television series created by Pendleton Ward has achieved both cult status and widespread popularity, and is now also the 16th set in the LEGO® Ideas series.

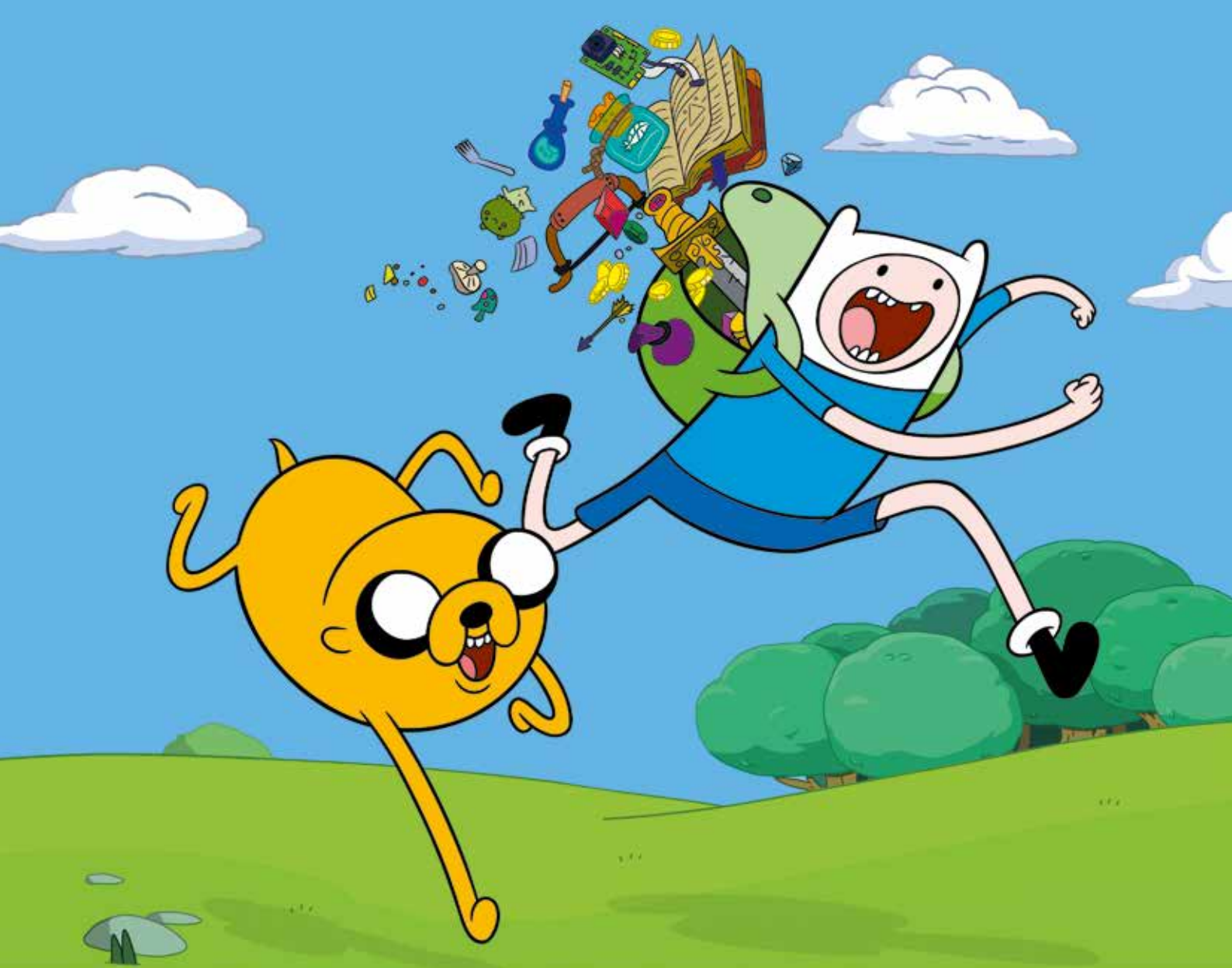



Finn

Finn is a silly kid who wants to become a great hero one day. He might not look too tough, but if there's evil around, he'll slay it. That's his deal.



Jake

Finn's best friend is a wise old dog with a big heart. Jake has the magical ability to stretch and grow. When evil's not running amok, he plays viola with his girlfriend, Lady Rainicorn.

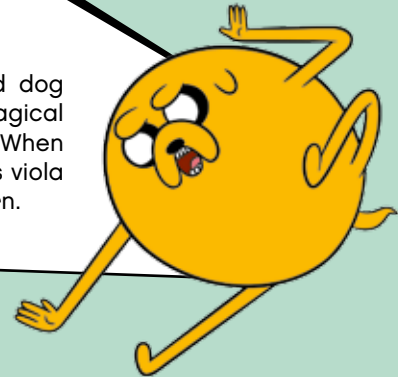



BMO

BMO is much more than just Finn and Jake's roommate. Beemo is also their friend, camera, alarm clock and video game system.

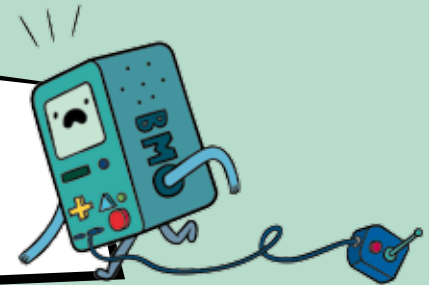

Marceline

Marceline is a wild rocker girl. Centuries of wandering the Land of Ooo have made her a Fearless daredevil.





Lady Rainicorn

Lady Rainicorn is Princess Bubblegum's loyal and majestic pet. Her love of the viola makes her a perfect match for Jake.



Princess Bubblegum

As a millionaire geek enthusiast, Princess Bubblegum immerses herself in every branch of geekdom from rocket science to turtle farming.





Ice King

Armed with a magic crown and an icy heart, the Ice King has only one goal: to secure a wife by any means necessary.



Gunter

Gunter is the name the Ice King gives to all of his penguin servants, yet he pronounces it differently depending on the penguin's personality.



C'est Adventure Time™!

Finn et son meilleur ami et Frère adoptif Jake, parcourent la terre d'Ooo, redressant les torts et luttant contre le mal. En chemin, ils se lient d'amitié avec de nombreux personnages loufoques, tels que la Princesse Chewing-Gum, Miss Rainicorne et Marceline, la reine vampire. Ils doivent aussi affronter le grognon Roi des glaces, méchant souverain du royaume des glaces, qui a vraiment besoin de se rafraîchir.

La série d'animation télévisée créée par Pendleton Ward a obtenu un statut culte et une vaste popularité, et est maintenant aussi le 16^e ensemble de la série LEGO® Ideas.



Finn

Finn est un garçon rigolo qui veut devenir un grand héros. Il n'a pas l'air très fort, mais il est capable de dominer le mal. C'est sa façon de fonctionner.



Jake

Le meilleur ami de Finn est un vieux chien sage avec un grand cœur. Jake a la capacité magique de s'étirer et grandir. Quand le mal ne sévit pas, il joue de l'alto avec son amie, Miss Rainicorne.





BMO

BMO est bien plus que le colocataire de Finn et Jake. BMO est aussi leur ami, caméra, réveil et console de jeu vidéo.

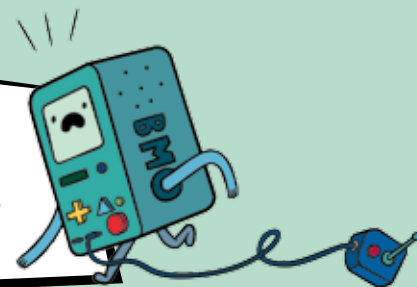

Marceline

Marceline est une rockeuse un peu sauvage. Des siècles passés à parcourir la Terre de Ooo en ont fait un casse-cou sans peur.





Miss Rainicorne

Miss Rainicorne est l'animal de compagnie loyal et majestueux de la Princesse Chewing-Gum. Son amour de l'alto en fait une compagne idéale pour Jake.



Princesse Chewing-Gum

En tant que geek millionnaire passionnée, la Princesse Chewing-Gum se plonge dans des domaines très variés, depuis la science des fusées jusqu'à l'élevage des tortues.





Le Roi des glaces

Armé d'une couronne magique et d'un cœur glacé, le Roi des glaces a un seul but : trouver une Femme par tous les moyens.



Gunter

Gunter est le nom que le Roi des glaces donne à tous ses serveurs pingouins, mais il le prononce différemment selon la personnalité du pingouin.



¡Es la hora de Adventure Time™!

Finn y su mejor amigo y hermano adoptado, Jake, viajan por la Tierra de Ooo resolviendo misterios y luchando contra el mal. A lo largo de su aventura, se hacen amigos de todo tipo de extraños personajes, como la Dulce Princesa, Arco Iris y Marceline, la reina de los vampiros. También tienen que soportar al gruñón Rey Helado, cruel gobernante del Reino Helado, que realmente necesita tranquilizarse un poco.

La serie de animación para televisión creada por Pendleton Ward es hoy objeto de culto, goza de una amplia popularidad y se ha convertido en el 16º set de la colección LEGO® Ideas.



Finn

Finn es un chico algo tonto que quiere convertirse en un gran héroe algún día. Puede que no se vea muy rudo, pero si el mal está cerca, lo destruirá. Ese es su negocio.



Jake

El mejor amigo de Finn es un sabio y viejo perro de gran corazón. Jake tiene la habilidad mágica de estirarse y crecer. Cuando el mal está bajo control, toca la viola con su novia, Arco Iris.





BMO

BMO no es sólo el compañero de cuarto de Finn y Jake. También es su amigo, su cámara, su reloj con alarma y su consola de videojuegos.

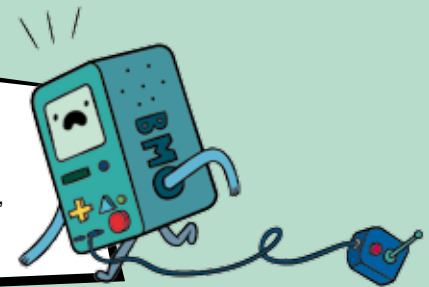

Marceline

Marceline es una salvaje roquera. Siglos de vagar por la Tierra de Ooo la han convertido en una valiente temeraria.





Arco Iris

Arco Iris es la leal y majestuosa mascota de la Dulce Princesa. Su amor por la viola la hace una pareja perfecta para Jake.



Dulce Princesa

Siendo una millonaria entusiasta de la tecnología, la Dulce Princesa se sumerge en cada rama de la ciencia, desde la astronáutica hasta la crianza de tortugas.





Rey Helado

Armado con una corona mágica y un corazón de hielo, el Rey Helado tiene un solo objetivo: asegurarse una esposa. Cueste lo que cueste.



Gunter

Gunter es el nombre por el que el Rey Helado conoce a todos sus siervos pingüinos, aunque lo pronuncia diferente según la personalidad de cada uno.





LEGO.com/brickseparator

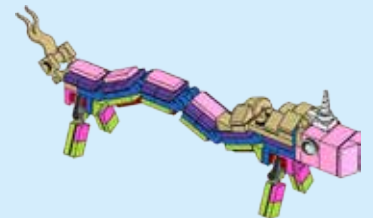
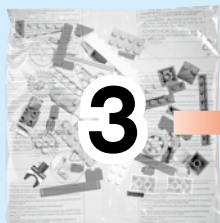
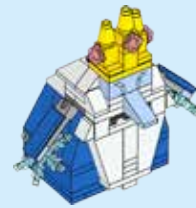
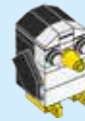
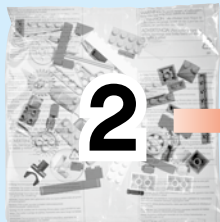
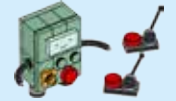

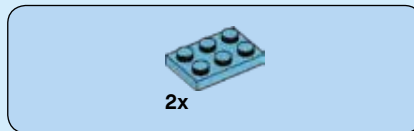
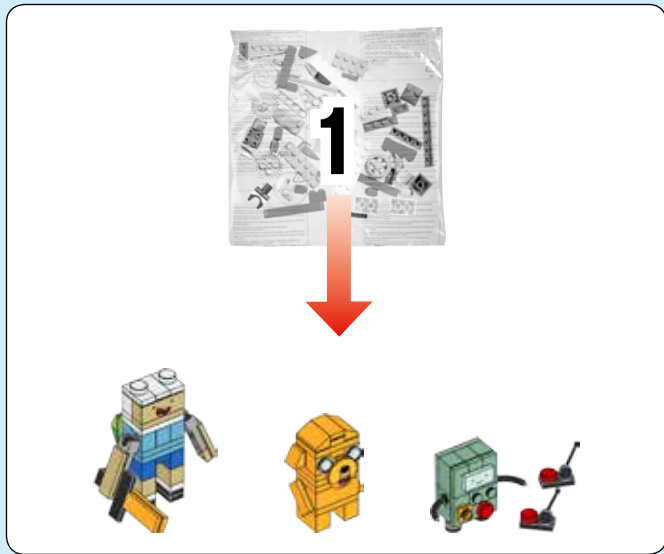

1

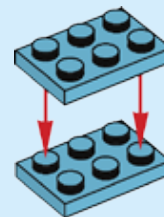



2

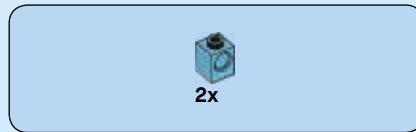
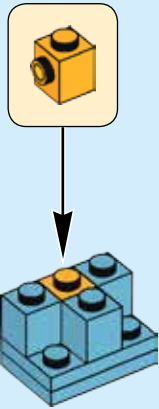

3

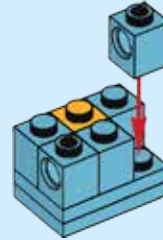

4

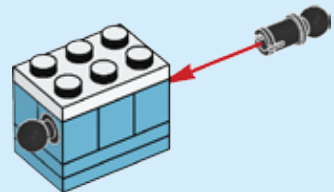

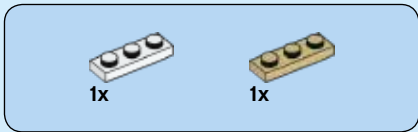

5

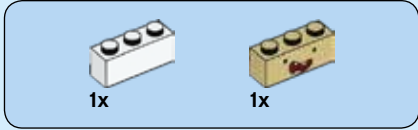
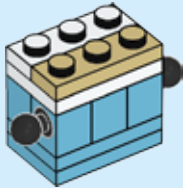

6

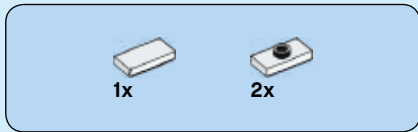
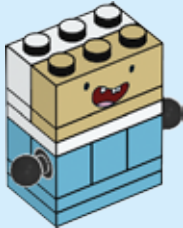

7

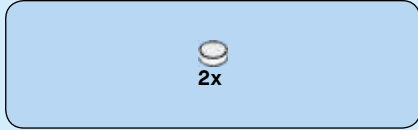
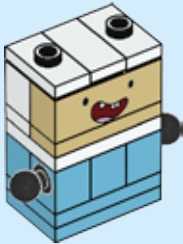

8

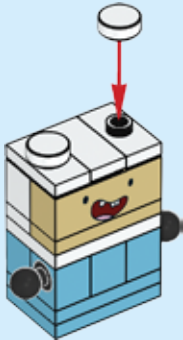

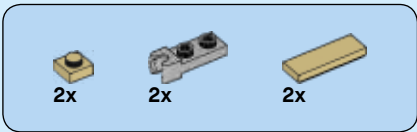

9

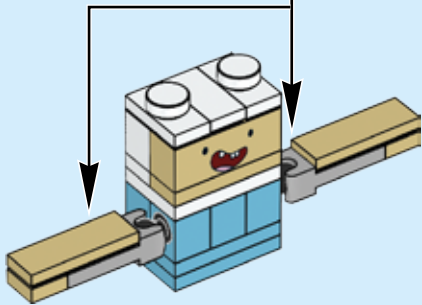
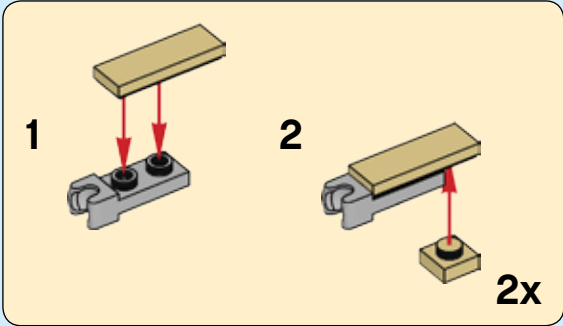

10

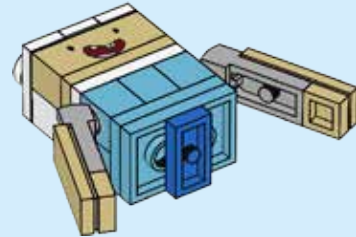
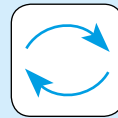



11

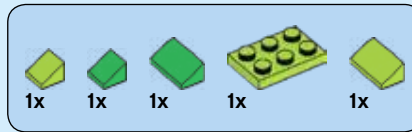
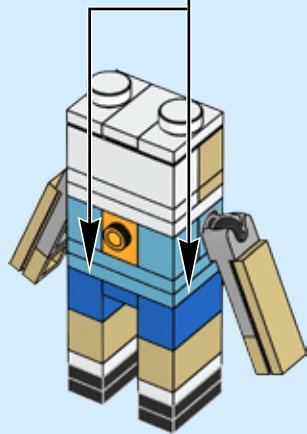
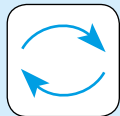
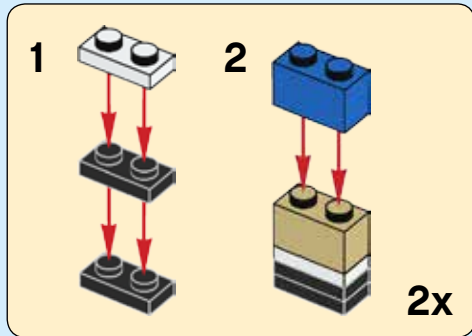

12

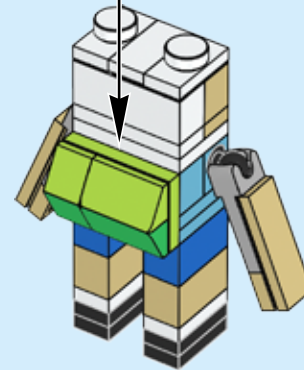
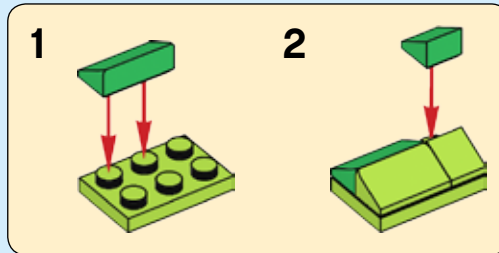

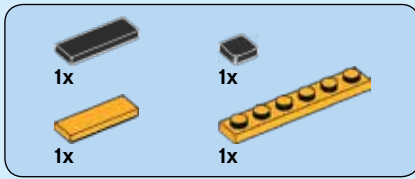

13

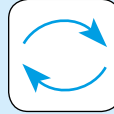

"You're beautiful on the inside, like,
your brain and stuff"

<< Tu es magnifique à l'intérieur, par
exemple, ton cerveau et tout >>

<<Eres bonita por dentro, con tu
cerebro y esas cosas>>

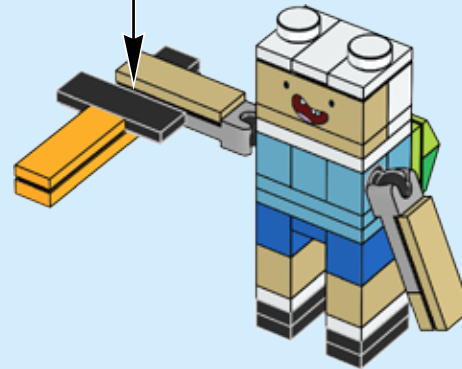
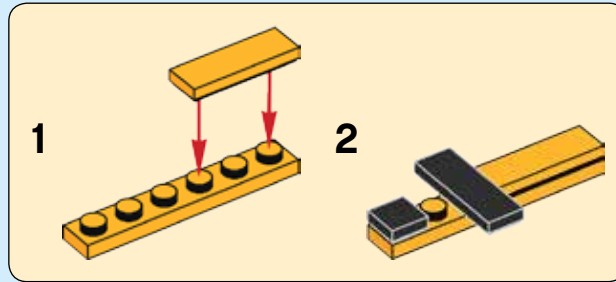
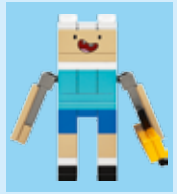



14



15

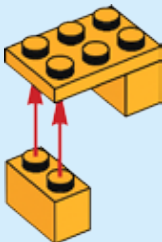

16

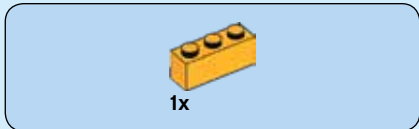
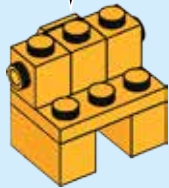
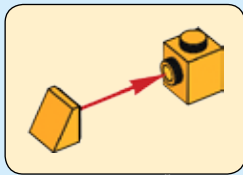

17





18

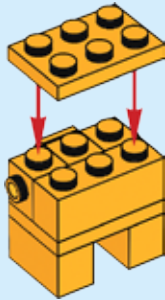

19

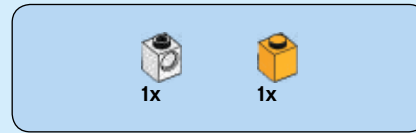
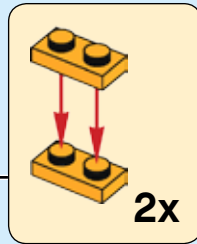
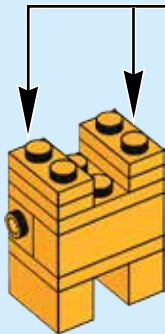

20

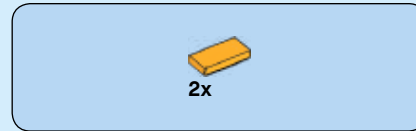

21

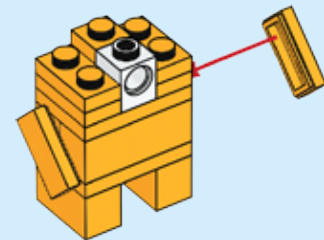



2x

22

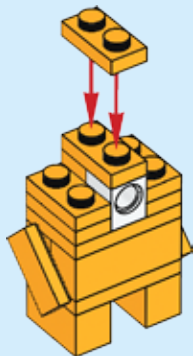

4x

23

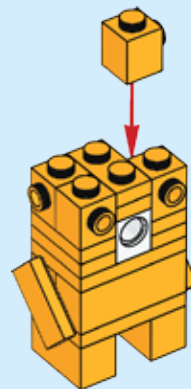



24

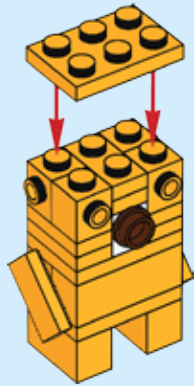

25

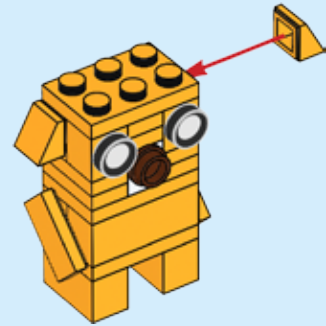



1x



1x

26



1x



2x

27

"Just do whatever you want, man.
As long as it comes from the inside"

« Fais ce que tu veux, mon ami.
Tant que cela vient de l'intérieur »

« Haz lo que quieras, compa.
Pero que salga de tu interior »

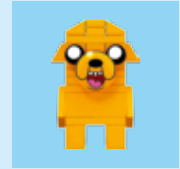

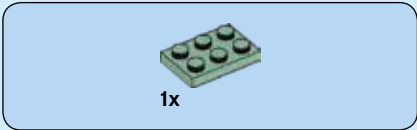
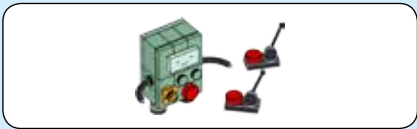

1x

28

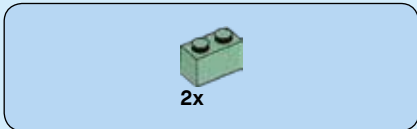
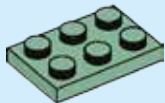

2x

29

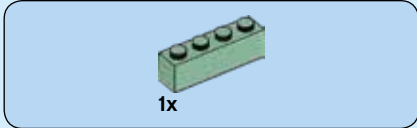
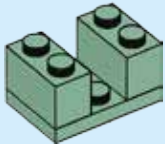

1x

30

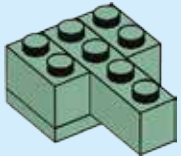



1x

31

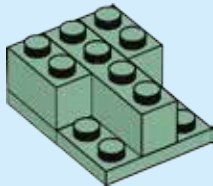

4x

32

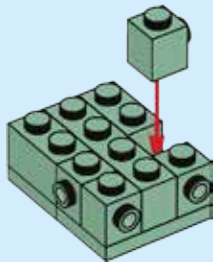

2x



1x



3x

33

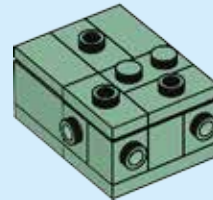

2x



1x



1x



1x

34

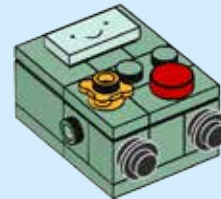

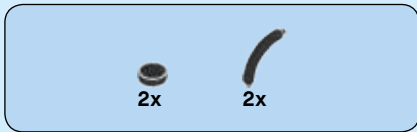

35

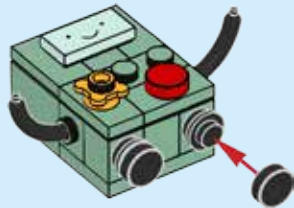

"Let's play video games!"
 << Jouons à des jeux vidéo ! >>
 << ¡Juguemos videojuegos! >>

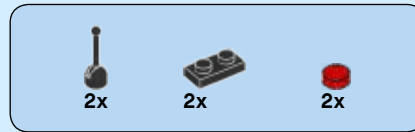

36

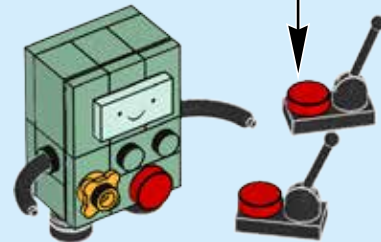
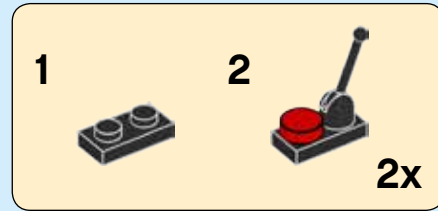
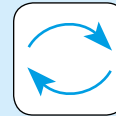

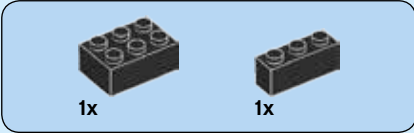
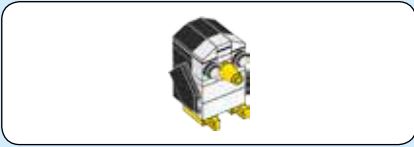
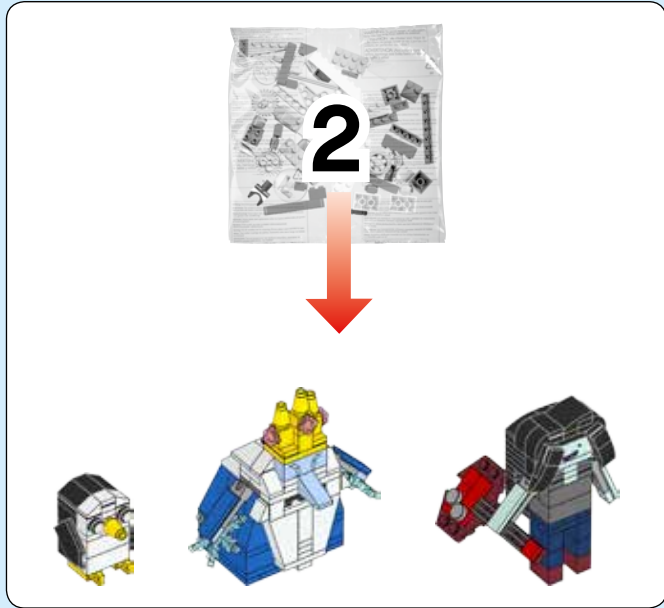

37

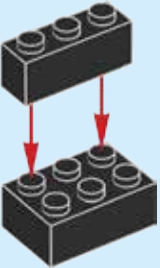

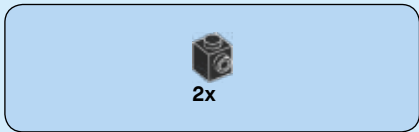

38

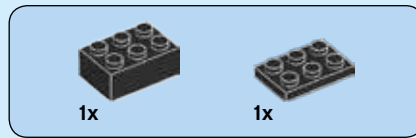
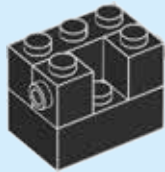

39

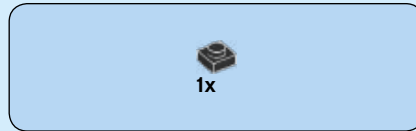
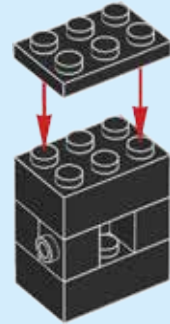

40

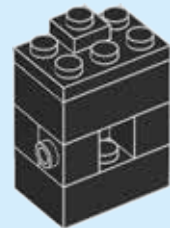

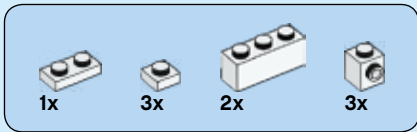

41

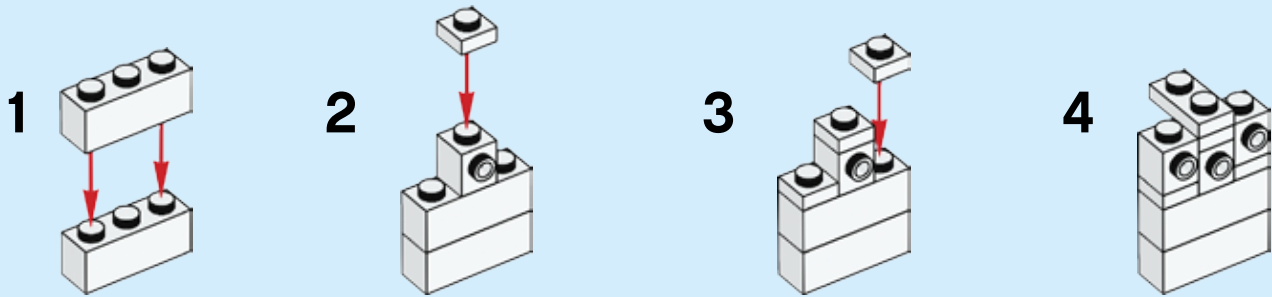

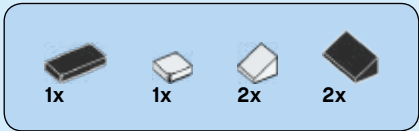

42

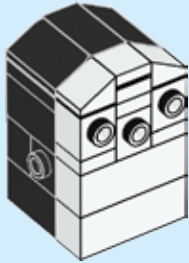
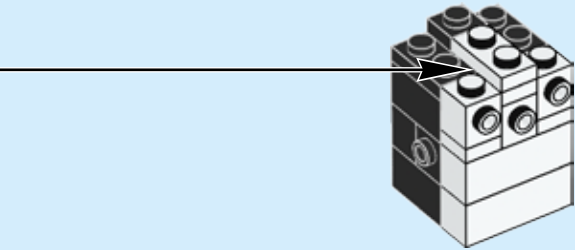



43

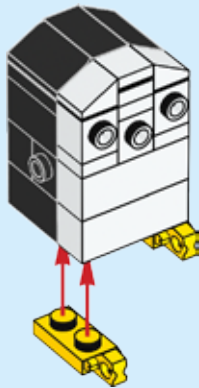

44

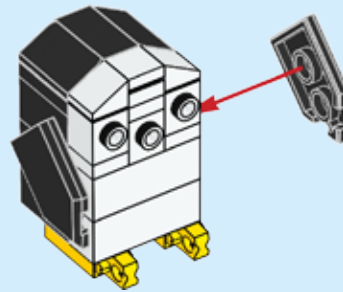



1x



2x

45

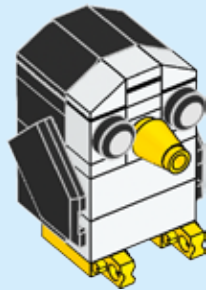

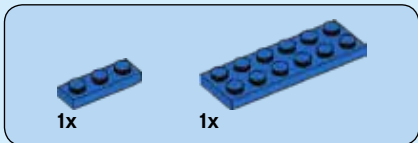
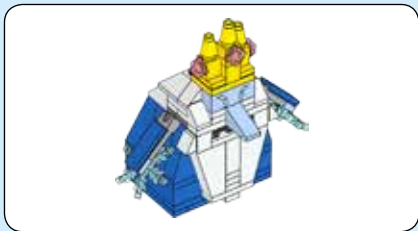

46

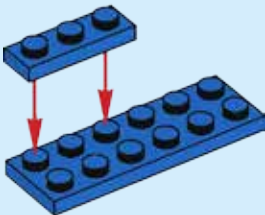

47

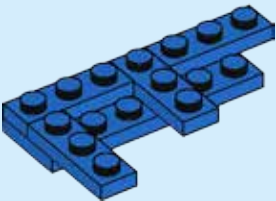

48

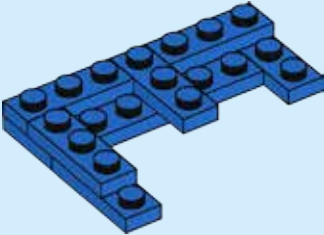



49

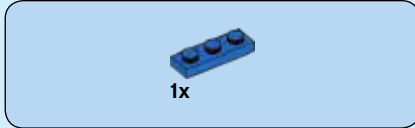
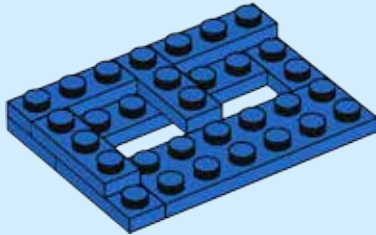

50

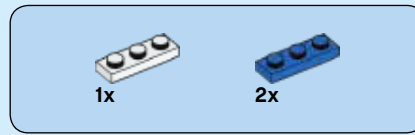
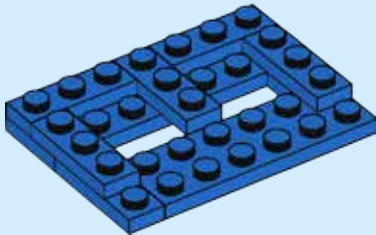

51

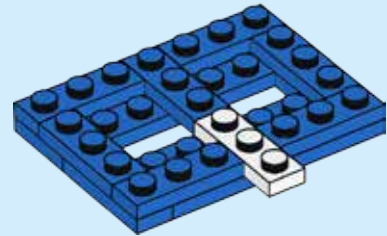

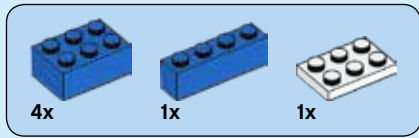

52

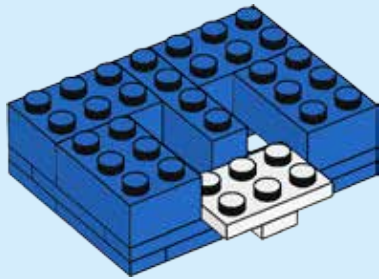

53

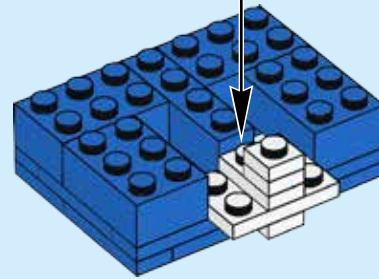
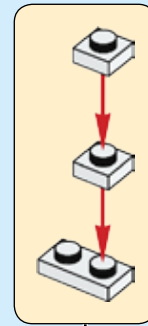

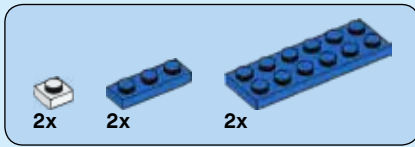

54

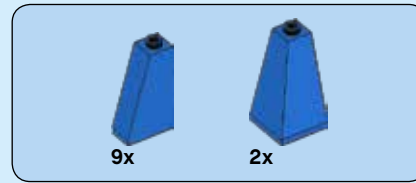
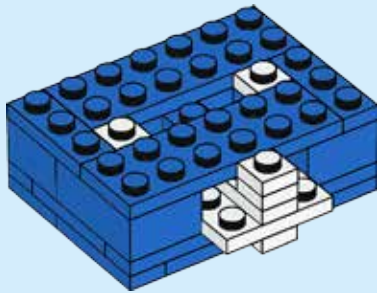

55

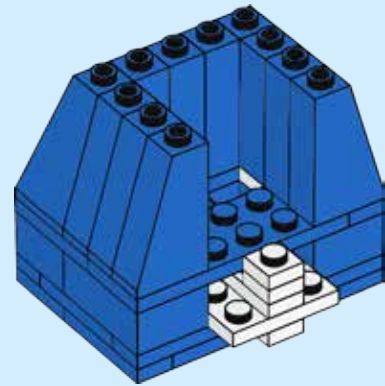

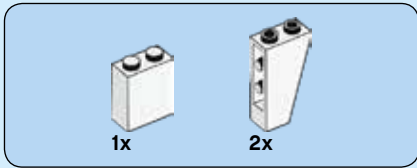

56

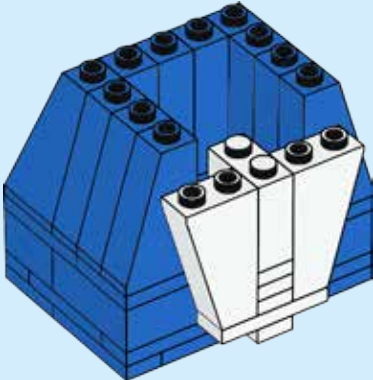

57

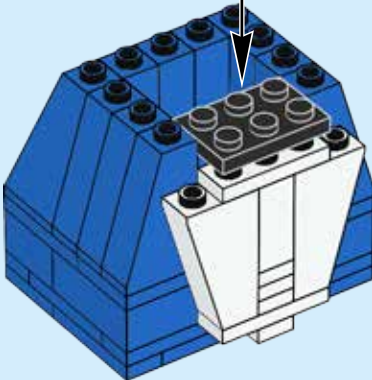
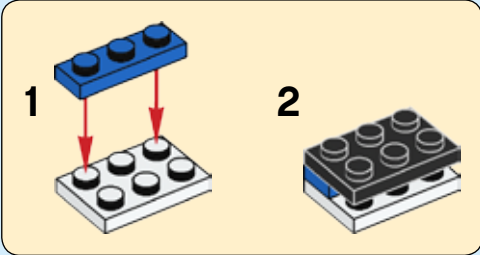

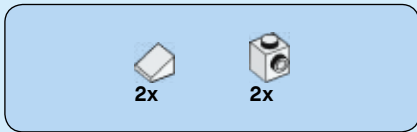

58

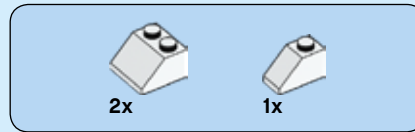
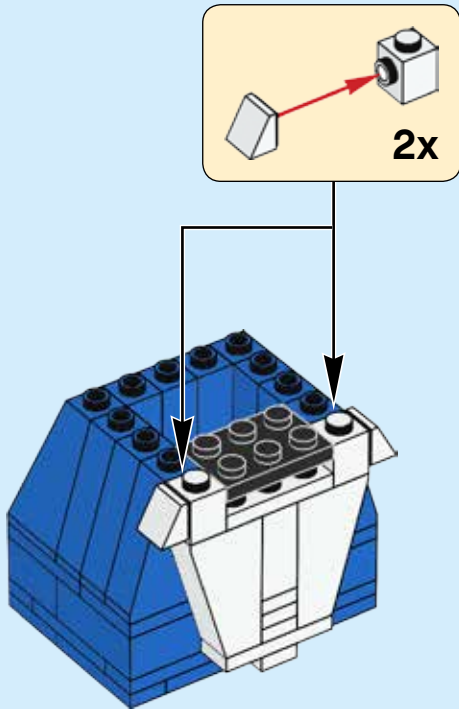

59

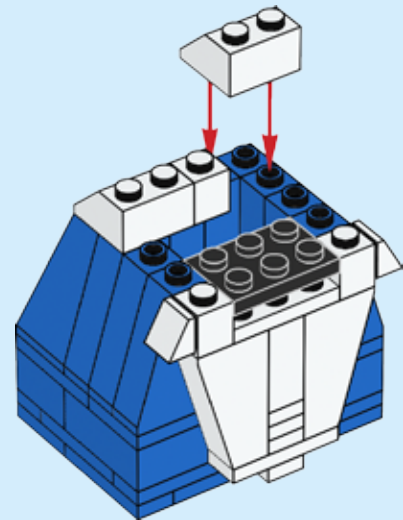

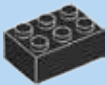

1x

60

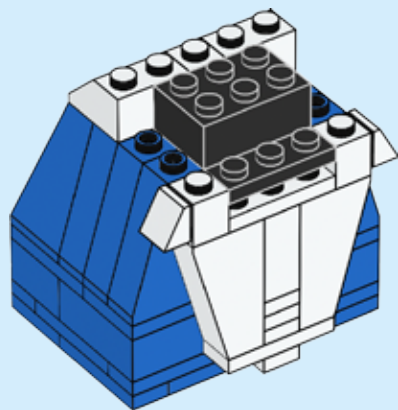

2x



2x

61

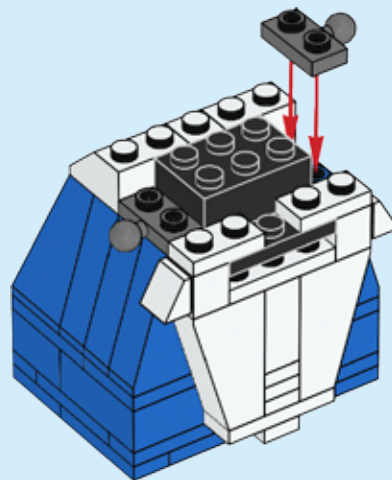

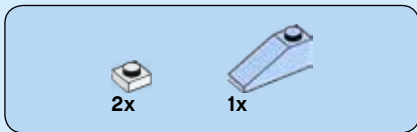

62

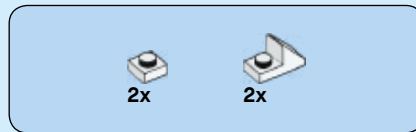
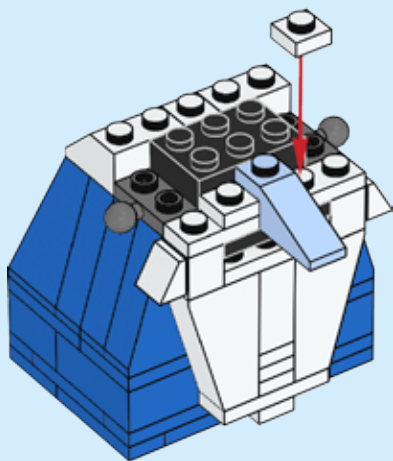

63

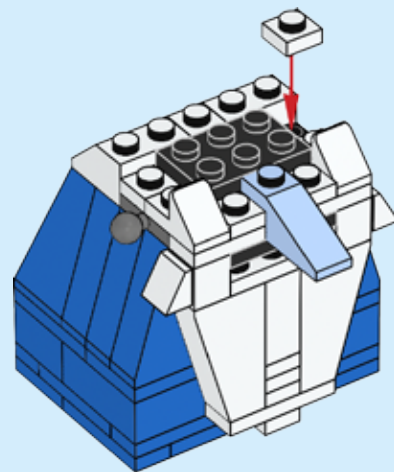

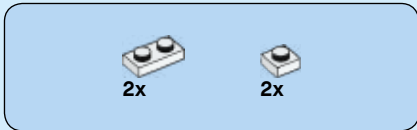

64

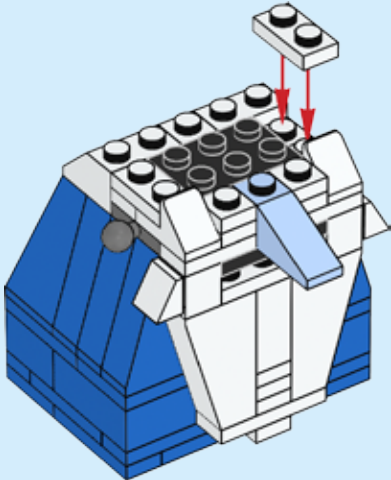

65

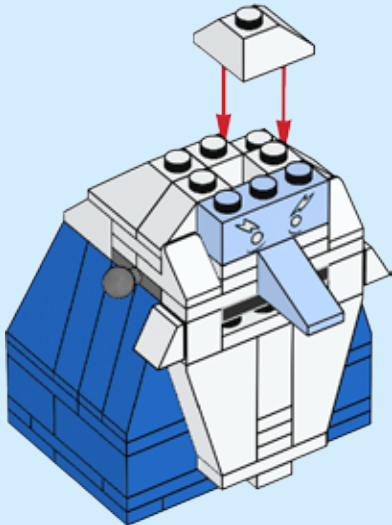



66

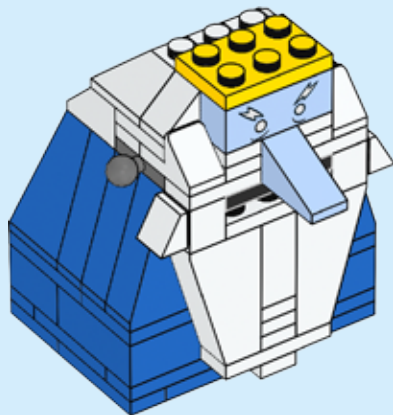

67

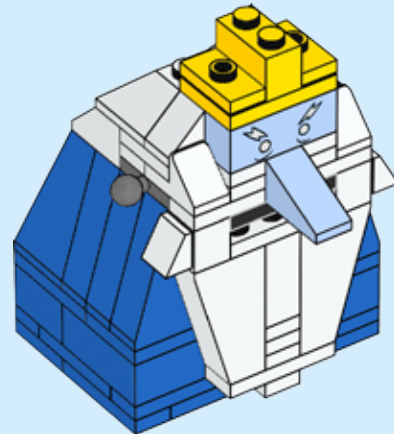



68

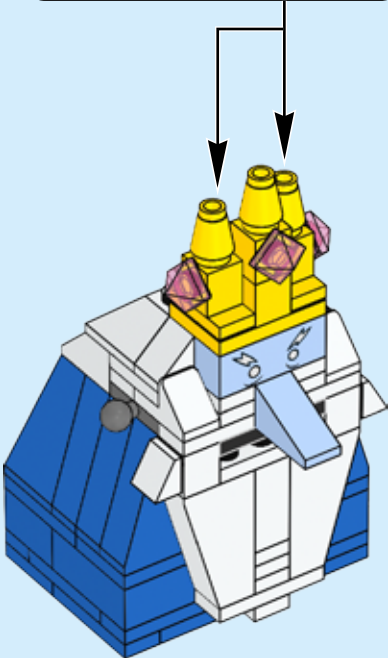
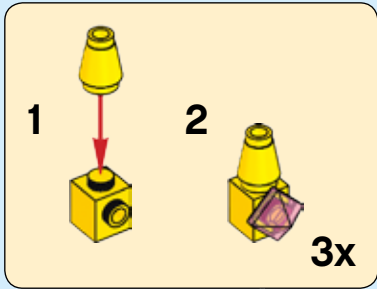

"I love you everything burrito"
« J'aime tout ce qui est burrito »
« ¡Te quiero todo, burrito »

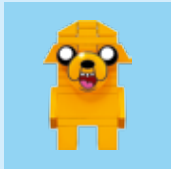

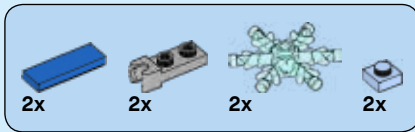

69

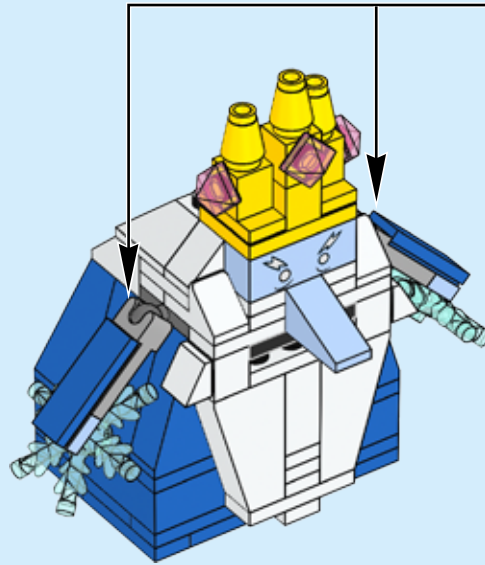
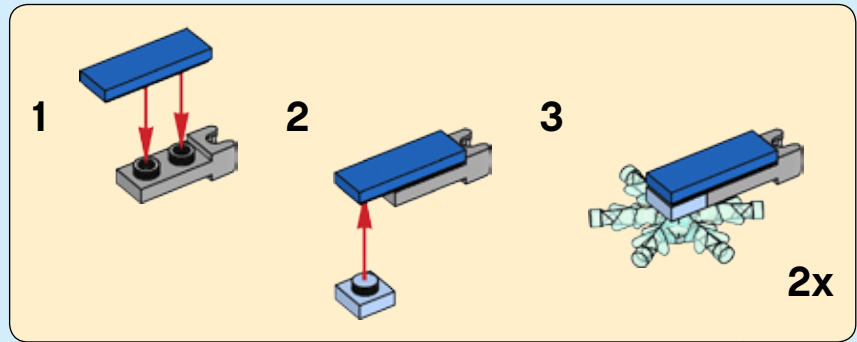

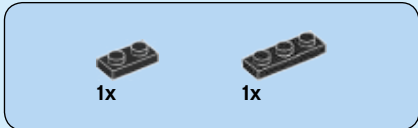
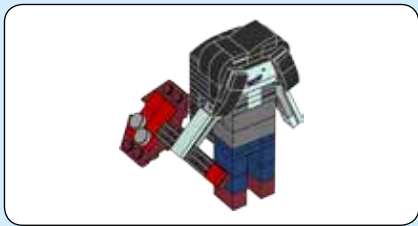

70

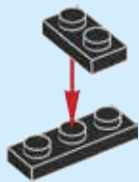

71

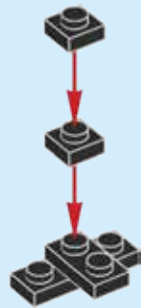

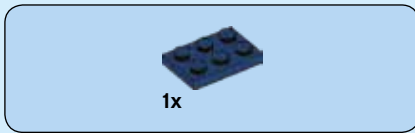

72

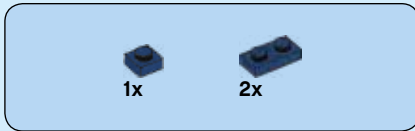
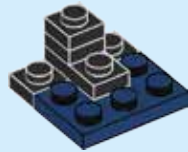

73

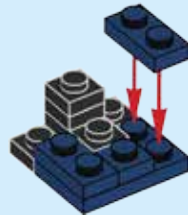

74

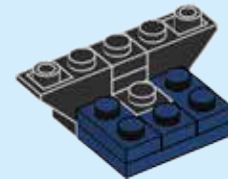

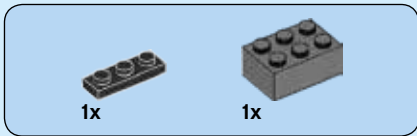

75

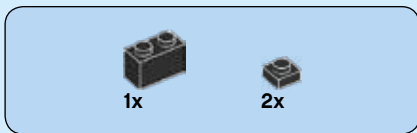
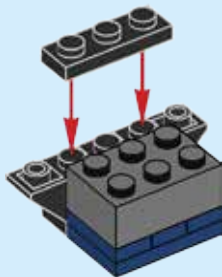

76

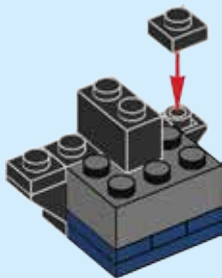

77

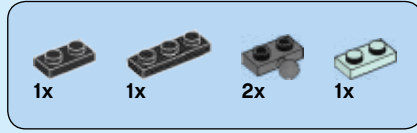
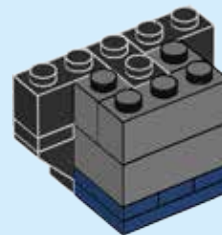

78

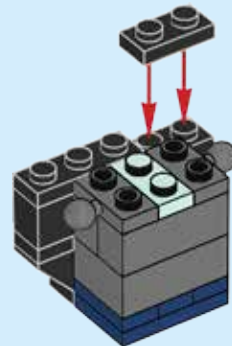

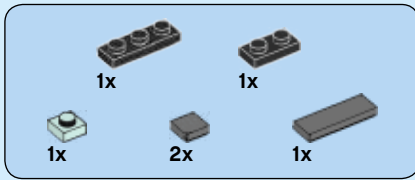

79

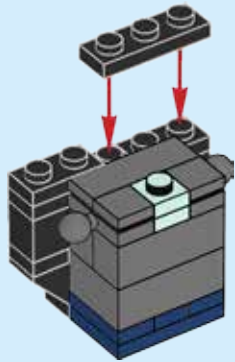

80

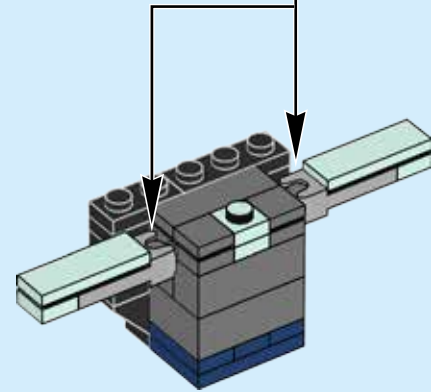
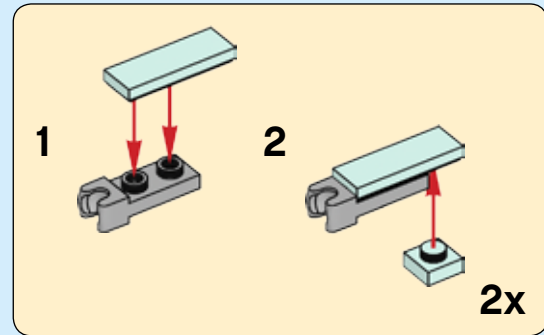



1x



1x

81

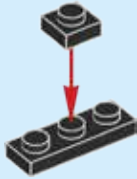

2x

82

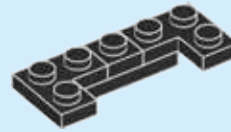

2x

83

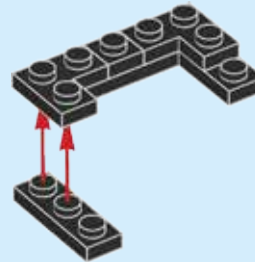

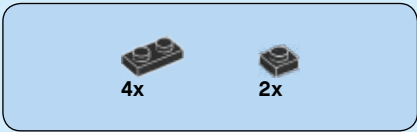

84

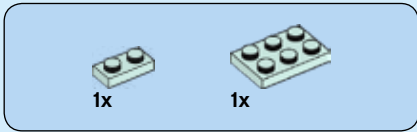
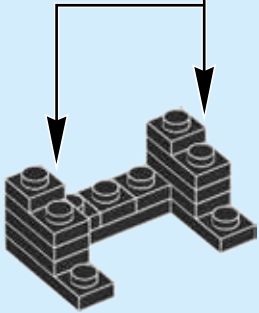
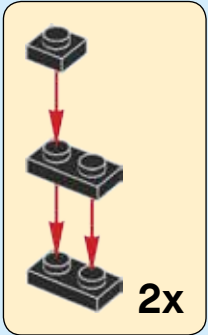

85

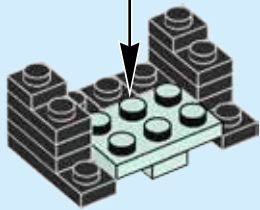
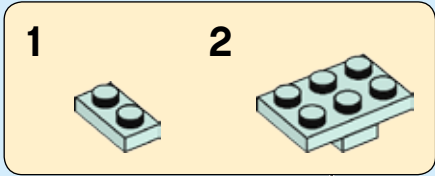

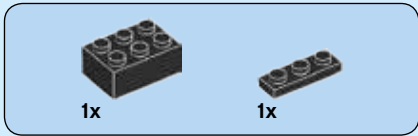

86

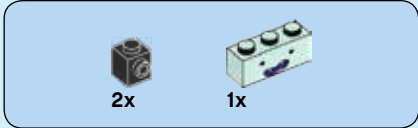
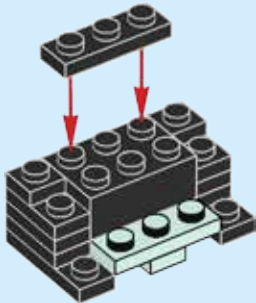

87

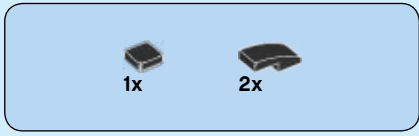
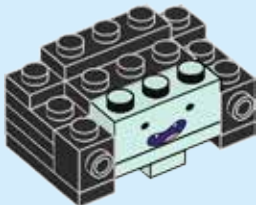

88

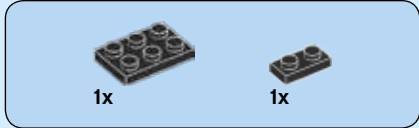
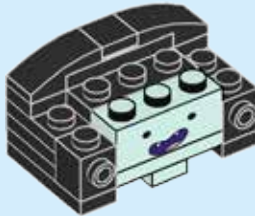

89

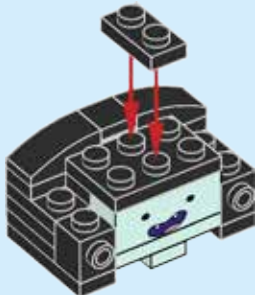



90

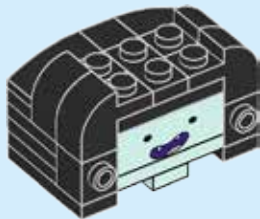

91

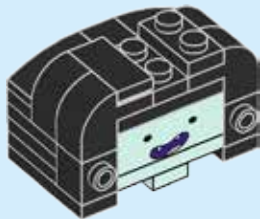

92

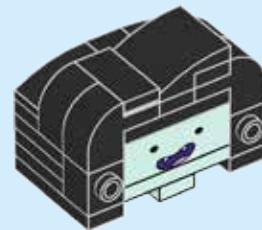

93

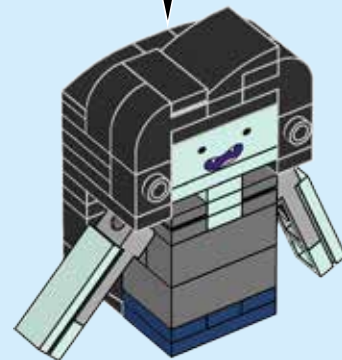



94

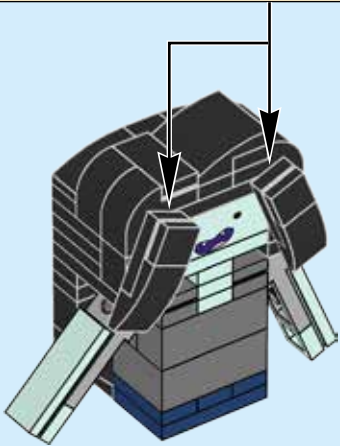
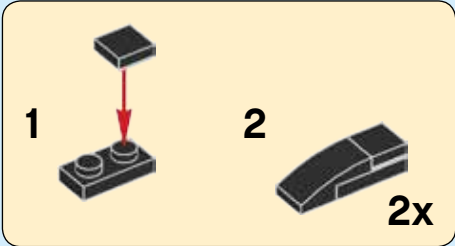

95

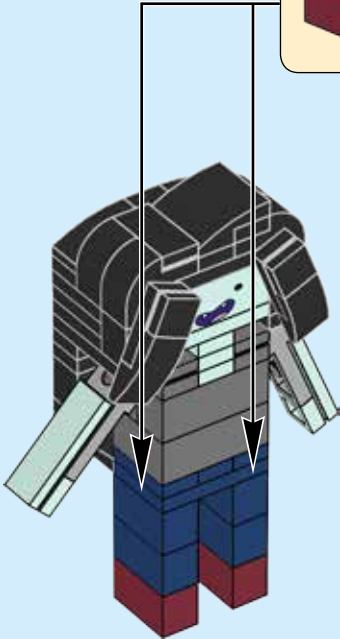
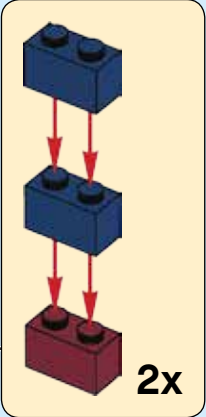



96



97

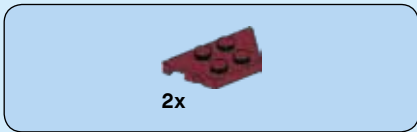
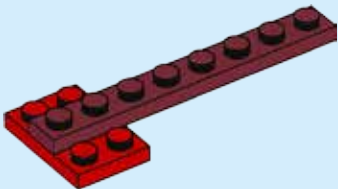

98

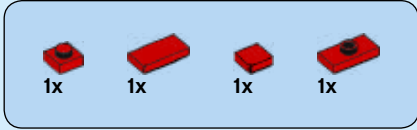
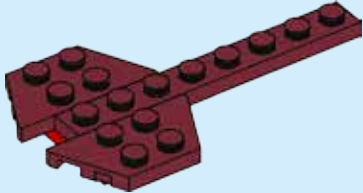

99

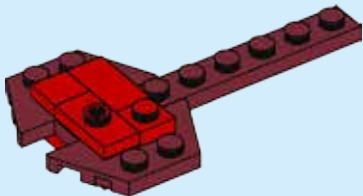



1x



2x



2x

100

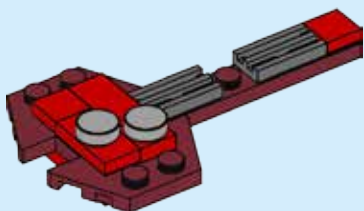

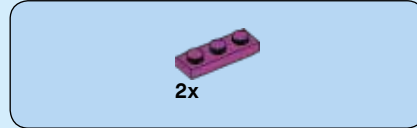
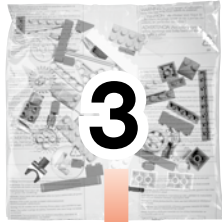

102

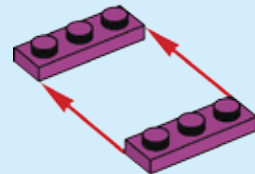



2x

103

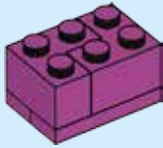

2x

104



2x



1x

105

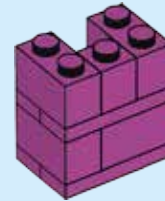

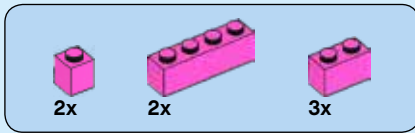

106

1

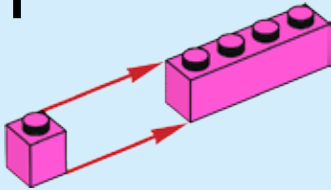

2

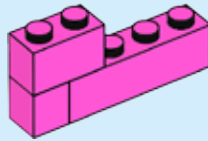

3

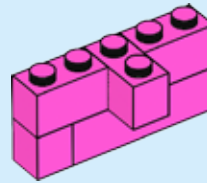

4

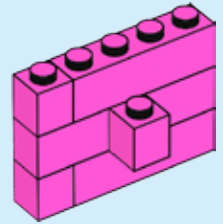

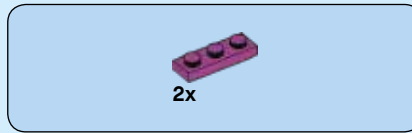
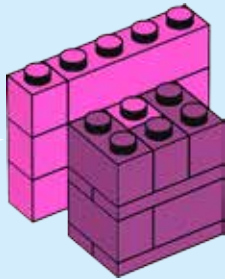

107

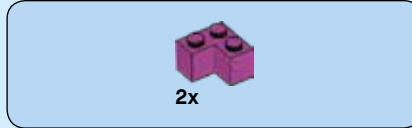
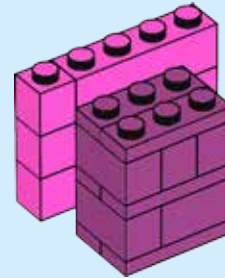

108

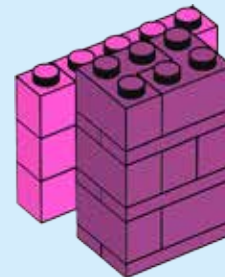

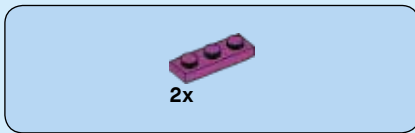

109

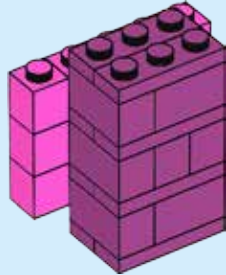

110



111



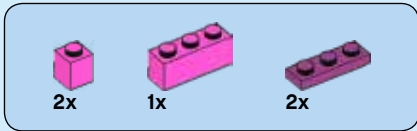

112

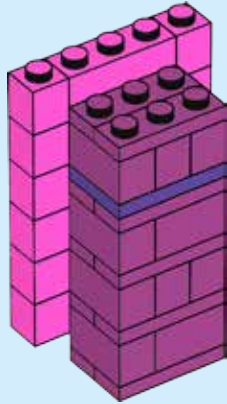

113

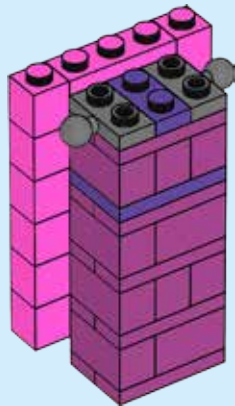

114

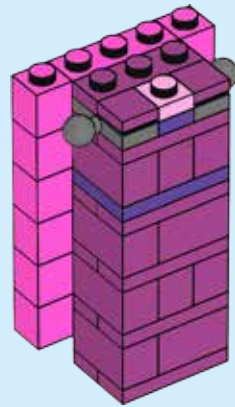



115

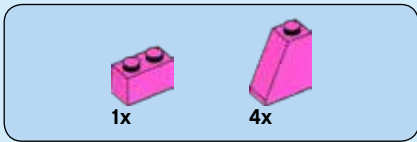
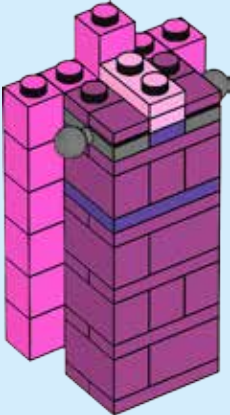

116

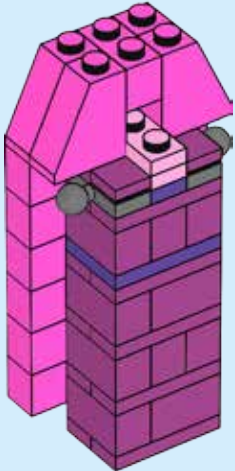

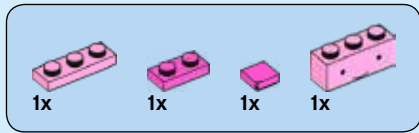

117

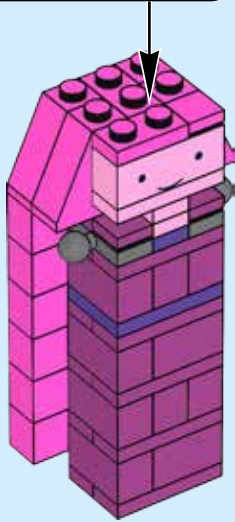
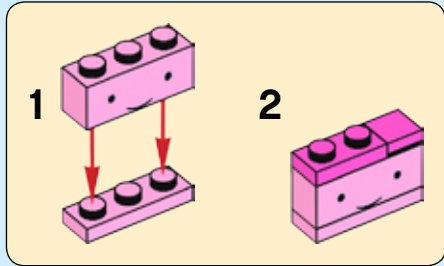

118

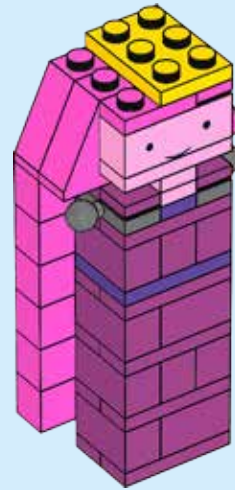



119

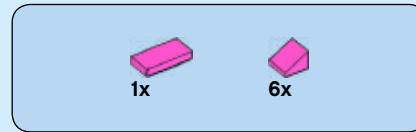
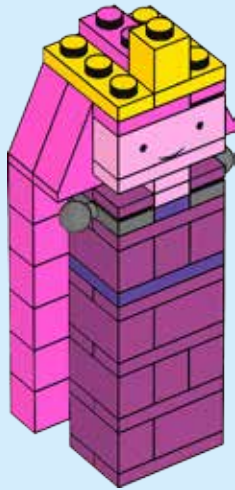

120

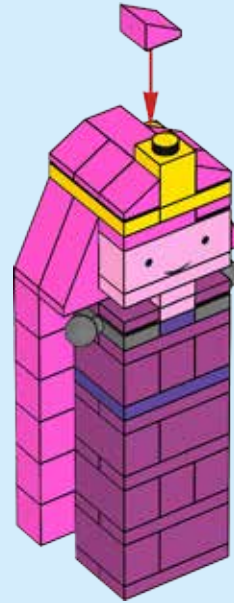



1x



1x

121

"Princess Power"
<< Pouvoir Princesse >>
<< Poder de princesa >>

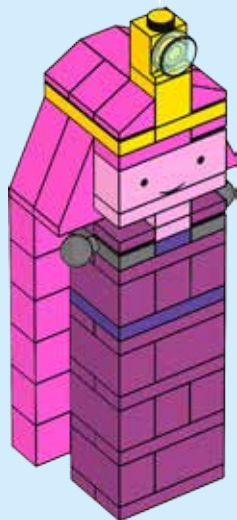
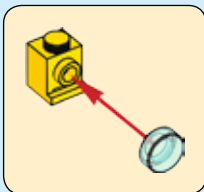
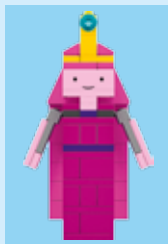

2x



2x



2x

122

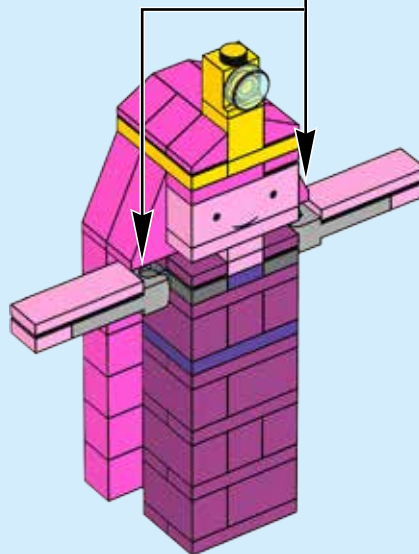
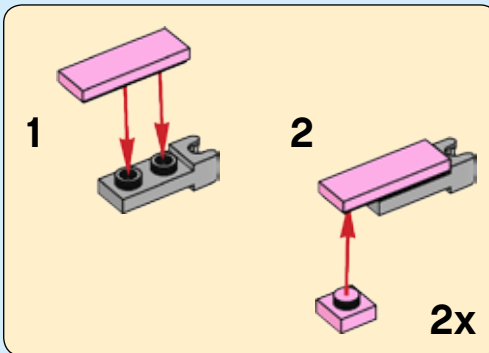

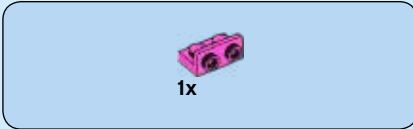
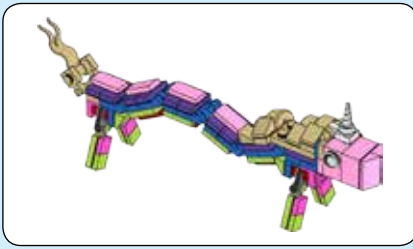

123



124



125



2x

126



1x

1x

127

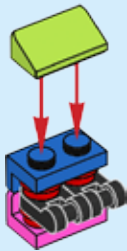

1x

1x

128

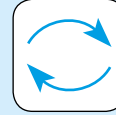

1x

2x

129

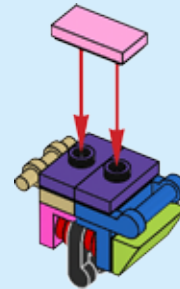

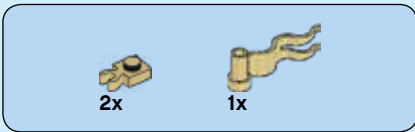

130

"Get your hero on, dude!"
<< Deviens un héros, mon ami! >>
<< ¡Saca tu héroe interior, hermano! >>

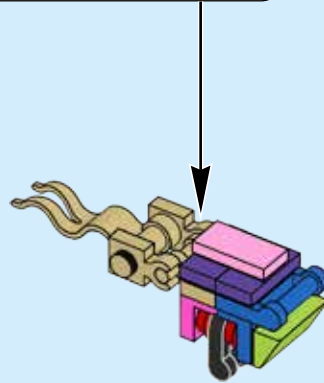
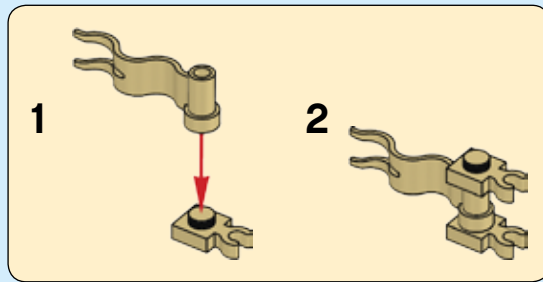



131

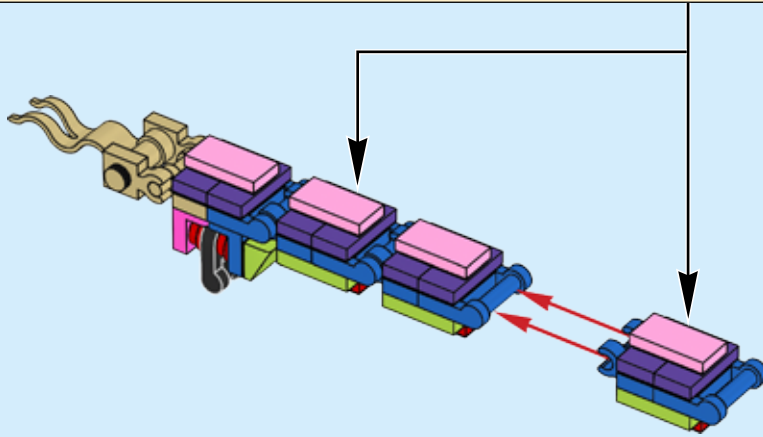
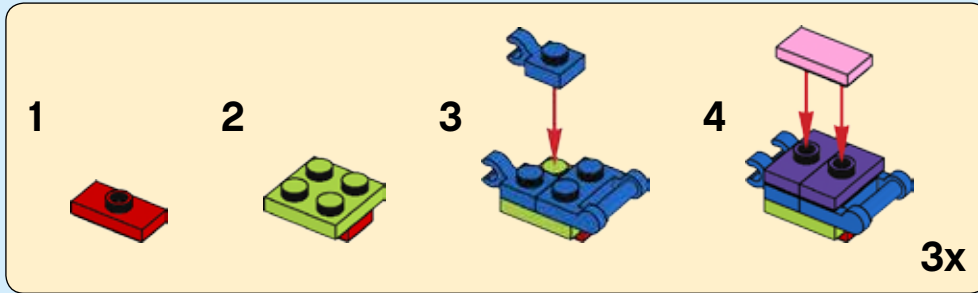



1x

132

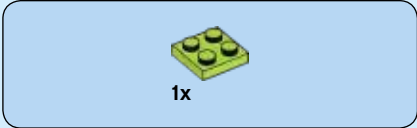

1x

133



1x

2x

134

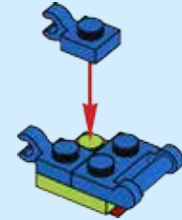

1x

1x

135

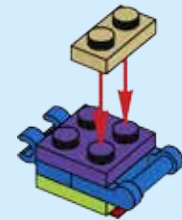



2x

136

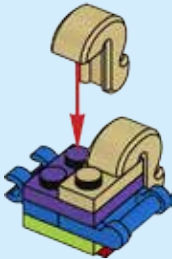

2x

137

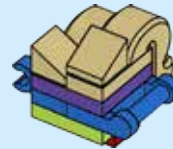

138

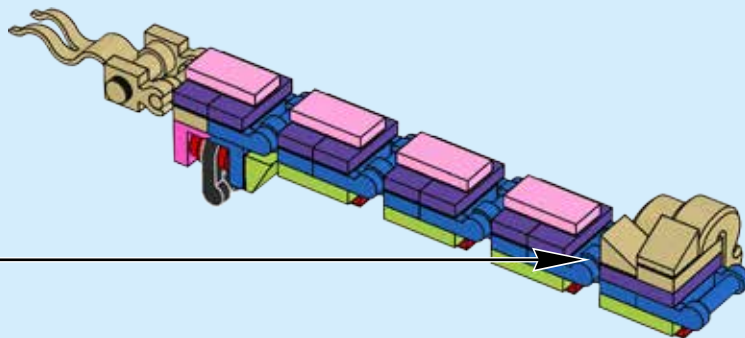



1x

139



2x

140



2x

141



2x

142





143

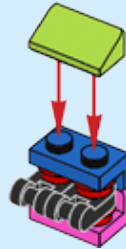

144

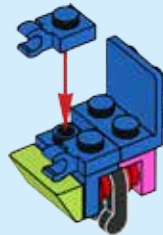
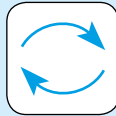

145

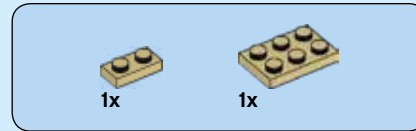
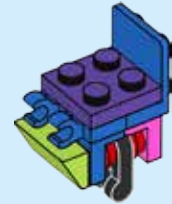

146

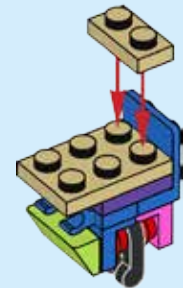



2x

147

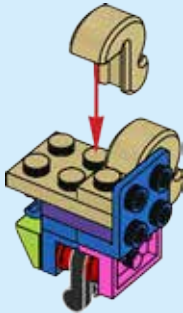

2x

148

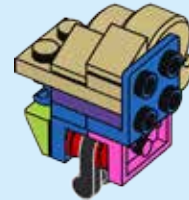



149

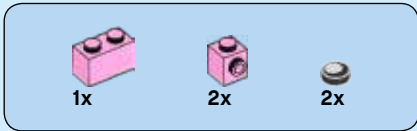
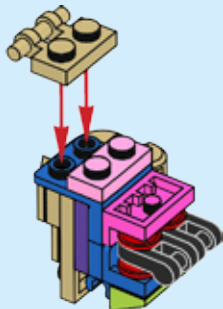
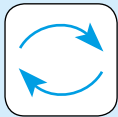

150

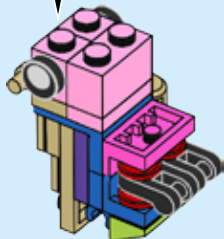
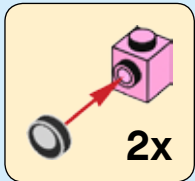



1x

151

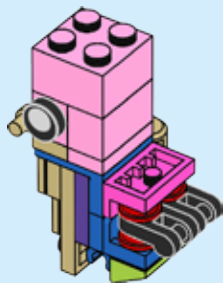

2x

152

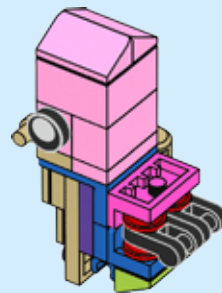

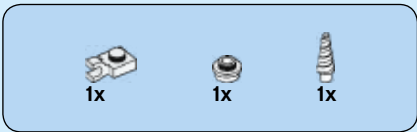

153

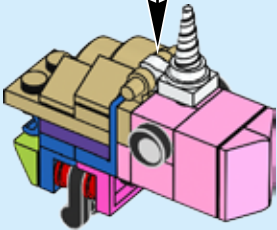
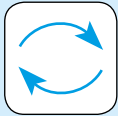
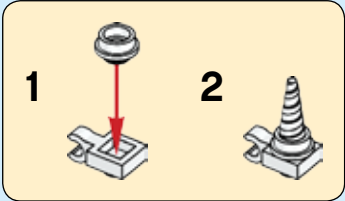

154

"Adventure 'til you drop"
« De l'aventure jusqu'à la fin »
« Aventura hasta desfallacer »

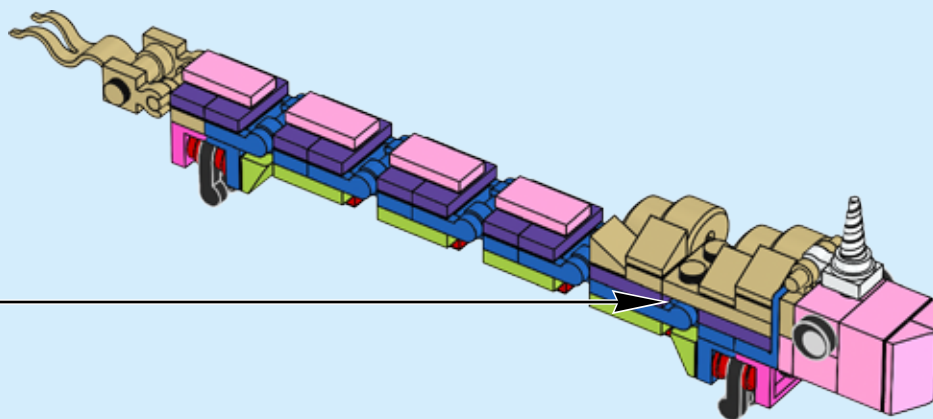
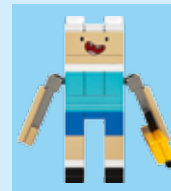

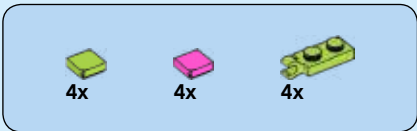

155

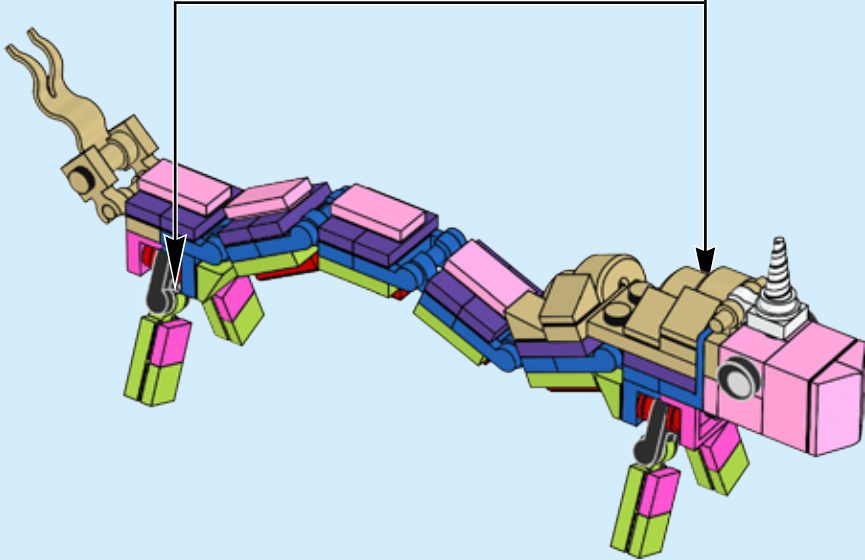
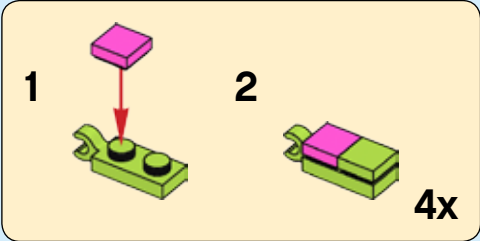

Fan designer

As a fan of both Adventure Time and LEGO® building, recreating the characters from the iconic cartoon series was a tough, but very satisfying task for Ludovic Piraud.

“I discovered Adventure Time after I’d read an article about a wacky cartoon series and decided to give the show a try. At first I was puzzled by it, then intrigued and finally completely hooked by its colorful universe and story.”

“The design of the characters in Adventure Time uses very round shapes, therefore LEGO® bricks don’t instantly feel like a good fit to reproduce these rounded shapes. However,

other elements like colors and proportions between shapes are often enough to make a character recognizable, so I thought I’d try to make block-like characters.”

“I’m just an occasional LEGO builder, so I asked for input from other LEGO Ideas users. The feedback I received was very constructive. The last project update is the most accomplished and that’s all thanks to the support from the community.”



LEGO® designer

As a LEGO designer, it was Adrian Florea's role to ensure the final model measured up to the exacting standards expected of all LEGO sets.

"I have followed the series since its first season and instantly liked the characters and the situations they found themselves in, so I was glad to be asked to work on this project."

"As Ludovic's original model was submitted as a 3D rendering and included some elements that were no longer available, I had to find ways to make everything work with the options we had. The same goes for colors, I had to make sure all the right elements were in the proper color."

"I love the line up of characters, but Marceline is my favorite. She has her own bass axe and she's a vampire. I'm from Transylvania and I play the bass in my spare time."



Le fan designer

Comme fan d'*Adventure Time*TM et de la construction LEGO®, recréer les personnages de la célèbre série d'animation a été une tâche difficile mais très satisfaisante pour Ludovic Piraud.

« J'ai découvert *Adventure Time* après avoir lu un article sur une série d'animation loufoque et j'ai décidé de la regarder. J'ai d'abord été très étonné, puis intrigué et finalement totalement absorbé par son univers coloré et son histoire.

Le design des personnages dans *Adventure Time* utilise des formes très rondes. À première vue, les briques LEGO ne semblent donc pas idéales pour reproduire ces formes arrondies.



Ludovic Piraud, le fan designer

Cependant, d'autres éléments tels que les couleurs et les proportions entre les formes sont assez souvent suffisants pour rendre un personnage reconnaissable, j'ai donc pensé à essayer de faire des personnages en blocs.

Je suis juste un constructeur LEGO occasionnel, j'ai donc demandé l'aide d'autres utilisateurs de LEGO Ideas. Les commentaires que j'ai reçus étaient très constructifs. La dernière mise à jour du projet est la plus aboutie et c'est grâce au soutien de la communauté. »

Le designer LEGO®

En tant que designer LEGO®, Adrian Florea devait s'assurer que le modèle final respectait les normes exigeantes attendues de tous les ensembles LEGO.

« J'ai suivi la série depuis la première saison et j'ai instantanément aimé les personnages et les situations dans lesquelles ils se trouvaient. J'ai donc été ravi qu'on me demande de travailler sur ce projet.

Comme le modèle original de Ludovic était soumis sous la forme d'un rendu en 3D et incluait des éléments qui n'étaient plus disponibles, j'ai dû trouver des façons de tout faire fonctionner avec les options dont nous disposions. Il en va de même pour les couleurs :

j'ai dû m'assurer que tous les éléments corrects étaient de la bonne couleur.

J'aime tous les personnages, mais Marceline est ma préférée. Elle a sa propre basse et c'est un vampire. Je viens de Transylvanie et je joue de la basse pendant mon temps libre. »



El fan diseñador

Como Fan de Adventure Time™ y los modelos LEGO®, recrear los personajes de la célebre serie de animación fue para Ludovic Piraud una tarea compleja, aunque gratificante.

«Descubrí Adventure Time después de leer un artículo sobre las series de animación más absurdas y decidí darle una oportunidad. Al principio me confundió, después me intrigó y, al final, su divertido universo y la historia me cautivaron por completo».

«Dado que el diseño de los personajes de Adventure Time se caracteriza por las formas redondeadas, los bricks LEGO no parecen ser la mejor opción a primera vista. Sin embargo, existen otros elementos, como los colores y



las proporciones entre las formas, que suelen ser suficientes para hacer reconocible a un personaje, así que pensé en representarlos mediante bloques».

«Sólo construyo con LEGO de vez en cuando, así que decidí pedir opiniones a otros usuarios de LEGO Ideas. La información que me proporcionaron fue muy constructiva. La última versión del proyecto fue la que más éxito tuvo, y todo fue gracias al apoyo de la comunidad».

El diseñador de LEGO®

Como diseñador de LEGO®, el papel de Adrian Florea consistió en garantizar que el modelo final estuviera a la altura de todos los demás sets LEGO.

«Sigo la serie desde la primera temporada. Los personajes y las situaciones a las que se enfrentan me gustaron desde el principio, así que me alegré de tener la oportunidad de trabajar en este proyecto».

«Como el modelo original de Ludovic era una representación 3D e incluía algunos elementos que ya no estaban disponibles, tuve que encontrar la manera de hacer que todo encajase con las opciones que teníamos. Sucedió lo mismo con los colores: tuve que

asegurarme de escoger los elementos apropiados en los colores correctos».

«Me encantan todos los personajes, pero Marceline es mi favorita. Tiene su propio bajo-hacha y es una vampiresa. Soy de Transilvania y toco el bajo en mi tiempo libre».



 1x 4113261	 1x 307001	 2x 4109995	 2x 300423	 10x 4520946	 3x 300426	 2x 306926	 1x 302421
 3x 362201	 13x 302401	 1x 6182793	 4x 300223	 2x 6163471	 1x 362226	 17x 302326	 2x 307021
 5x 4558952	 8x 302301	 4x 4516055	 1x 301023	 1x 6133720	 4x 300226	 2x 242026	 1x 306921
 1x 654101	 1x 306901	 2x 4159553	 1x 301023	 5x 4514398	 4x 4558954	 2x 6128992	 5x 6092565
 4x 4504369	 2x 6051511	 2x 4113917	 9x 4121925	 1x 300524	 2x 4548180	 8x 362326	 1x 302121
 2x 6069002	 2x 362301	 2x 6131896	 9x 4121925	 1x 300424	 2x 366526	 1x 4558170	 8x 614121
 4x 4121932	 3x 302101	 1x 4121921	 2x 6184480	 3x 4624985	 4x 6047276	 3x 302126	 3x 6063445
 2x 4532972	 1x 4538353	 1x 4118790	 1x 302323	 1x 407024	 4x 609126	 4x 6157554	 1x 4504372
 2x 4233370	 1x 4547649	 2x 6029889	 12x 362323	 4x 4525464	 4x 6053077	 2x 614126	 3x 6025026
 2x 303901	 2x 4646844	 2x 4140593	 2x 4587840	 2x 6092583	 1x 6182792	 2x 6139403	 4x 4537937
	 1x 6156242	 1x 6150130	 4x 379523	 1x 362324	 6x 6182792	 2x 73587	 4x 6013530
		 4x 6109586		 2x 4588025	 4x 307026	 2x 6156414	 4x 6138122

1x 6022171	2x 4616581	1x 6061685	2x 4211098	6x 4492224	1x 4517993	8x 6092604	1x 6182795
2x 6136391	1x 4521947	2x 6003003	1x 4211104	7x 4621545	1x 4550359	1x 4655695	3x 6058016
1x 4546705	4x 6009656	1x 6061688	1x 4211105	1x 4618655	1x 6182796	2x 6047422	2x 6146701
1x 6000071	3x 6184432	8x 6092035	2x 4210848	3x 4621542	2x 4621554	1x 4225142	1x 6182789
2x 6022035	2x 4616578	3x 6023173	2x 4210631	6x 6127601	2x 4649749	3x 4619652	1x 6182789
4x 4519195	1x 4655080	2x 6024286	2x 4210631	4x 6062343	3x 6031883	2x 6145253	2x 6184485
4x 6109979	2x 6184348	3x 4622062	1x 4568734	4x 6062343	4x 4580010	2x 4619513	2x 6184485
2x 6099364	2x 4539102	7x 6028736	6x 6039479	5x 6133726	2x 4654128	1x 4619513	1x 6192108
11x 6022048	1x 4541507	1x 6099725	6x 6039479	1x 6133726	2x 6070317	1x 4654448	3x 6172693
4x 4249891	2x 4541544	3x 6097503	1x 6182794	1x 6056381	2x 6070317	1x 4654448	3x 6172693
1x 4184108	1x 4216581	1x 6020074	1x 6182794	2x 6057387	1x 6036788	1x 4654448	3x 6172693
2x 4528981	2x 4650260	1x 6182797	1x 6056239	2x 6057387	1x 6036788	1x 4654448	3x 6172693
1x 4530028	8x 6043639	1x 6170304	2x 6184484	2x 6099449	1x 6036788	1x 4654448	3x 6172693

Customer Service

Kundenservice

Service Consommateurs

Servicio Al Consumidor

LEGO.com/service or dial



: 00800 5346 5555

: 1-800-422-5346

SHARE YOUR IDEA
PARTAGE TON IDÉE
COMPARTE TU IDEA

LEGO® REVIEW
EXAMEN LEGO®
REVISIÓN DE LEGO®



GATHER SUPPORT
OBTIENS DE L'APPUI
OBTÉN APOYOS



NEW LEGO® PRODUCT
NOUVEAU PRODUIT LEGO®
NUEVO PRODUCTO LEGO®



LEGO.COM/IDEAS

Do you like this LEGO® Ideas set?

The LEGO® Group would like your opinion on the new product you have just purchased. Your feedback will help shape the future development of this product series. Please visit:

[LEGO.com/productsurvey](https://www.lego.com/productsurvey)

By completing our short feedback survey, you will be automatically entered into a drawing to win a LEGO® prize.

See website for official rules and details. Open to all countries where not prohibited.

Aimez-vous cet ensemble LEGO® Ideas ?

Le Groupe LEGO® aimerait connaître votre opinion sur le produit que vous venez d'acheter. Vos commentaires nous aideront à concevoir les futurs produits de cette gamme. Veuillez visiter :

[LEGO.fr/productsurvey](https://www.lego.fr/productsurvey)

En remplissant ce court sondage sur le produit, vous serez automatiquement inscrit à un tirage au sort pour gagner un prix LEGO®. Consultez le site Web pour obtenir le règlement officiel et les détails. Ouvert à tous les résidents des pays autorisés.



¿Te gusta este set LEGO® Ideas?

The LEGO® Group quiere conocer tu opinión acerca del nuevo producto que acabas de comprar. Tus comentarios nos ayudarán a dar forma a los futuros productos de esta serie. Visita:

[LEGO.com/productsurvey](https://www.lego.com/productsurvey)

Al contestar este breve cuestionario de opinión, participarás automáticamente en el sorteo de un producto LEGO®. Consulta las reglas oficiales y demás información en el sitio web. Válido en todos los países en los que esta actividad no esté prohibida.

LEGO and the LEGO logo are trademarks of the/son des marques de commerce du/son marcas registradas de LEGO Group.
©2017 The LEGO Group.

ADVENTURE TIME, CARTOON NETWORK, the logos, and all related characters and elements are trademarks of and © Cartoon Network. (s16)

6196769